

ENGINEERED THROUGH THE DRIVER'S EYES



PRO STOCK / PRO MOD

ENGINEERED FOR MAXIMUM PERFORMANCE

The Pro Stock/Pro Mod body reigns as the preferred choice for top drag racers. It is meticulously engineered to deliver maximum performance on the drag strip, making it the ultimate selection for those seeking speed, precision & winning results.



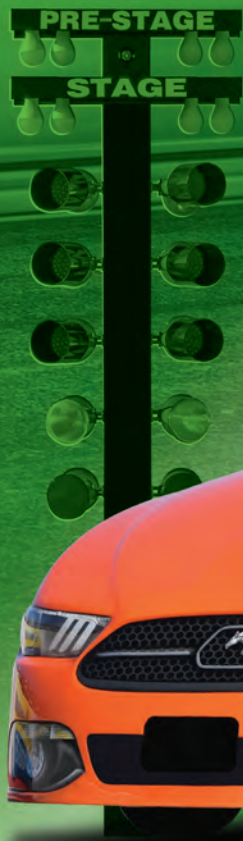

- » Available in 3 composite blends:
- » **LIGHTWEIGHT COMPOSITE:** Body weighs under 80 lbs
- » **CARBON FIBER:** Body weighs under 70 lbs
- » **ULTRA LIGHT CARBON FIBER:** Body weighs under 60 lbs
- » Fits 105" to 115" wheelbase chassis
- » Gray ready to paint finish on all parts

CONNECT WITH TEAM FIVE STAR | FIVESTARBODIES.COM    

CAMARO BODY PANELS & OPTIONS

* CARBON FIBER BODY PANELS SOLD THROUGH CHEVROLET PERFORMANCE

» BILL SCHEMERS: 810.397.9688 EMAIL: BILL.S@TGIDIRECT.COM

| PRO STOCK BODY PACKAGES | LIGHTWEIGHT COMPOSITE | | *CARBON FIBER | | *ULTRA LIGHT CARBON FIBER | |
|---|-----------------------|-----------------|--------------------|--------------|---------------------------|--------------|
| Dash | 64131-90012 | \$698 | N/A | N/A | N/A | N/A |
| Deck Lid | 64131-31012 | \$401 | 64131-31017 | *CALL | 64131-31018 | *CALL |
| Door, left | 64131-21012L | \$1,018 | 64131-21017L | *CALL | 64131-21018L | *CALL |
| Door, right | 64131-21012R | \$1,018 | 64131-21017R | *CALL | 64131-21018R | *CALL |
| Front Clip, 1-piece UP TO 105" WHEELBASE, SCOOPED | 64132-43012 | \$3,484 | 64132-43017 | *CALL | 64132-43018 | *CALL |
| Front Clip, 1-piece UP TO 105" WHEELBASE, EFI | 64132-43012-2 | \$3,484 | 64132-43017-2 | *CALL | 64132-43018-2 | *CALL |
| Rear Clip, 1-piece | 64131-51712 | \$4,167 | 64131-51717 | *CALL | 64131-51718 | *CALL |
| Spoiler, Spill Plates | 913-6700-SP | \$215 | COS0604-SP | \$347 | N/A | N/A |
| Spoiler, Wing | XC 962-6700L-W | \$385 | XC 962-6700C-W | \$464 | XC 962-6700U-W | \$480 |
| PRO STOCK BODY PACKAGE PRICE | 64131-10312 | \$11,386 | 64131-10317 | *CALL | 64131-10318 | *CALL |

| PRO MOD BODY PACKAGES | LIGHTWEIGHT COMPOSITE | | *CARBON FIBER | | *ULTRA LIGHT CARBON FIBER | |
|---|-----------------------|-----------------|--------------------|--------------|---------------------------|--------------|
| Dash | 64131-90012 | \$698 | N/A | N/A | N/A | N/A |
| Deck Lid | 64131-31012 | \$401 | 64131-31017 | *CALL | 64131-31018 | *CALL |
| Door, left | 64131-21012L | \$1,018 | 64131-21017L | *CALL | 64131-21018L | *CALL |
| Door, right | 64131-21012R | \$1,018 | 64131-21017R | *CALL | 64131-21018R | *CALL |
| Front Clip, 1-piece UP TO 115" WHEELBASE, SCOOPED | 65132-43012 | \$3,607 | 65132-43017 | *CALL | 65132-43018 | *CALL |
| Front Clip, 1-piece UP TO 115" WHEELBASE, EFI | 65132-43012-2 | \$3,607 | 65132-43017-2 | *CALL | 65132-43018-2 | *CALL |
| Rear Clip, 1-piece | 64131-51712 | \$4,167 | 64131-51717 | *CALL | 64131-51718 | *CALL |
| Spoiler, Spill Plates | 913-6700-SP | \$215 | COS0604-SP | \$347 | N/A | N/A |
| Spoiler, Wing | XC 962-6700L-W | \$385 | XC 962-6700C-W | \$464 | XC 962-6700U-W | \$480 |
| PRO MOD BODY PACKAGE PRICE | 65131-10312 | \$11,509 | 65131-10317 | *CALL | 65131-10318 | *CALL |

IMPORTANT: LEAD TIMES MAY VARY. PRICE DOES NOT INCLUDE SHIPPING OR THE ADDITIONAL CRATING FEES APPLIED AT TIME OF PURCHASE FOR COMPLETE BODIES.

PRO STOCK / PRO MOD WINDOWS & HEADLIGHT LENS COVERS TINTED WINDOWS AVAILABLE ON OUR WEBSITE

| | | |
|--|-----------------|----------|
| Windshield, molded, mar-resistant coated, 3/16", OVERSIZED | 64131-63302 | \$397 |
| Windshield, molded, mar-resistant coated, 3/16", cut to fit, beveled | 64131-63332 | \$472 |
| Windshield, molded, mar-resistant coated, 1/8", OVERSIZED | 64131-63202 | \$382 |
| Windshield, molded, mar-resistant coated, 1/8", cut to fit, beveled | 64131-63232 | \$409 |
| Door Window, molded, mar-resistant coated, 1/8", OVERSIZED, left or right | 64131-62202LorR | \$158 ea |
| Door Window, molded, mar-resistant coated, 1/8", cut to fit, beveled, left or right | 64131-62232LorR | \$191 ea |
| Door Window, molded, mar-resistant coated, .093", OVERSIZED, left or right | 64131-62102LorR | \$126 ea |
| Door Window, molded, mar-resistant coated, .093", cut to fit, beveled, left or right | 64131-62132LorR | \$145 ea |
| Quarter Window, molded, mar-resistant coated, 1/8", cut to fit, beveled, drilled, left or right | 64131-65242LorR | \$42 ea |
| Quarter Window, molded, mar-resistant coated, .093", cut to fit, beveled, drilled, left or right | 64131-65142LorR | \$40 ea |
| Rear Window, molded, mar-resistant coated, 1/8", cut to fit, beveled, drilled | 64131-61242 | \$398 |
| Rear Window, molded, mar-resistant coated, .093", cut to fit, beveled, drilled | 64131-61142 | \$264 |
| Headlight Lens Covers, molded, mar-resistant coated polycarbonate, pair | 60132-68142 | \$72 |

VINYL NOSE & TAIL ID GRAPHIC ID KITS FOR A REALISTIC DEM LOOK!

PRINTED ON OUTDOOR DURABLE HIGH-TACK VINYL • GLOSS LAMINATED SURFACE PROVIDES EXCELLENT PROTECTION



CHEVROLET CAMARO

| | | |
|---------|-------------|------|
| Nose ID | 60131-44142 | \$38 |
| Tail ID | 60131-44542 | \$38 |

» FOR OLDER CAMARO PRO STOCK BODY PANELS, CALL OUR SALES TEAM

MUSTANG BODY PANELS & OPTIONS

HOW TO ORDER YOUR BODY IN 3 QUICK & EASY STEPS

» 1. SELECT BODY TYPE » 2. SPECIFY WITH OR WITHOUT SCOOP » 3. SELECT MATERIAL

| PRO STOCK BODY PACKAGES | LIGHTWEIGHT COMPOSITE | CARBON FIBER | ULTRA LIGHT CARBON FIBER |
|---|-----------------------------|-----------------------------|-----------------------------|
| Dash | 960-900L \$698 | N/A | N/A |
| Deck Lid | 64321-31012 \$401 | 64321-31017 \$398 | 64321-31018 \$440 |
| Door, left | 64321-21012L \$1,011 | 64321-21017L \$1,076 | 64321-21018L \$1,157 |
| Door, right | 64321-21012R \$1,011 | 64321-21017R \$1,076 | 64321-21018R \$1,157 |
| Front Clip, 1-piece UP TO 105" WHEELBASE, SCOOPED | 64321-43012 \$3,202 | 64321-43017 \$4,085 | 64321-43018 \$4,754 |
| Front Clip, 1-piece UP TO 105" WHEELBASE, EFI | 64321-43012-2 \$3,202 | 64321-43017-2 \$4,085 | 64321-43018-2 \$4,754 |
| Rear Clip, 1-piece | 64321-51712 \$4,255 | 64321-51717 \$5,177 | 64321-51718 \$6,170 |
| Spoiler, Spill Plates | 913-6700-SP \$215 | CCS0604-SP \$347 | N/A |
| Spoiler, Wing | 64321-48012 \$392 | 64321-48017 \$445 | 64321-48018 \$486 |
| PRO STOCK BODY PACKAGE PRICE | 64321-10312 \$11,185 | 64321-10317 \$13,302 | 64321-10318 \$15,209 |

| PRO MOD BODY PACKAGES | LIGHTWEIGHT COMPOSITE | CARBON FIBER | ULTRA LIGHT CARBON FIBER |
|---|-----------------------------|-----------------------------|-----------------------------|
| Dash | 960-900L \$698 | N/A | N/A |
| Deck Lid | 64321-31012 \$401 | 64321-31017 \$398 | 64321-31018 \$440 |
| Door, left | 64321-21012L \$1,011 | 64321-21017L \$1,076 | 64321-21018L \$1,157 |
| Door, right | 64321-21012R \$1,011 | 64321-21017R \$1,076 | 64321-21018R \$1,157 |
| Front Clip, 1-piece UP TO 115" WHEELBASE, SCOOPED | 65321-43012 \$3,202 | 65321-43017 \$4,085 | 65321-43018 \$4,754 |
| Front Clip, 1-piece UP TO 115" WHEELBASE, EFI | 65321-43012-2 \$3,202 | 65321-43017-2 \$4,085 | 65321-43018-2 \$4,754 |
| Rear Clip, 1-piece | 64321-51712 \$4,255 | 64321-51717 \$5,177 | 64321-51718 \$6,170 |
| Spoiler, Spill Plates | 913-6700-SP \$215 | CCS0604-SP \$347 | N/A |
| Spoiler, Wing | 64321-48012 \$392 | 64321-48017 \$445 | 64321-48018 \$486 |
| PRO MOD BODY PACKAGE PRICE | 65321-10312 \$10,086 | 65321-10317 \$12,206 | 65321-10318 \$14,071 |

IMPORTANT: LEAD TIMES MAY VARY. PRICE DOES NOT INCLUDE SHIPPING OR THE ADDITIONAL CRATING FEES APPLIED AT TIME OF PURCHASE FOR COMPLETE BODIES.

PRO STOCK / PRO MOD WINDOWS & HEADLIGHT LENS & TAIL LIGHT COVERS TINTED WINDOWS AVAILABLE ON OUR WEBSITE

| | | |
|--|-----------------|----------|
| Windshield, molded, mar-resistant coated, 3/16", OVERSIZED | 64321-63302 | \$379 |
| Windshield, molded, mar-resistant coated, 3/16", cut to fit, beveled | 64321-63332 | \$406 |
| Windshield, molded, mar-resistant coated, 1/8", OVERSIZED | 64321-63202 | \$353 |
| Windshield, molded, mar-resistant coated, 1/8", cut to fit, beveled | 64321-63232 | \$383 |
| Door Window, molded, mar-resistant coated, 1/8", OVERSIZED, left or right | 64321-62202LorR | \$144 ea |
| Door Window, molded, mar-resistant coated, 1/8", cut to fit, beveled, left or right | 64321-62232LorR | \$176 ea |
| Door Window, molded, mar-resistant coated, .093", OVERSIZED, left or right | 64321-62102LorR | \$121 ea |
| Door Window, molded, mar-resistant coated, .093", cut to fit, beveled, left or right | 64321-62132LorR | \$145 ea |
| Quarter Window, molded, mar-resistant coated, 1/8", cut to fit, beveled, drilled, left or right | 64321-65242LorR | \$121 ea |
| Quarter Window, molded, mar-resistant coated, .093", cut to fit, beveled, drilled, left or right | 64321-65142LorR | \$88 ea |
| Rear Window, molded, mar-resistant coated, 1/8", cut to fit, beveled, drilled | 64321-61242 | \$398 |
| Rear Window, molded, mar-resistant coated, .093", cut to fit, beveled, drilled | 64321-61142 | \$242 |
| Headlight Lens Covers, molded, mar-resistant coated polycarbonate, pair | 60321-68142 | \$52 |
| Tail Light Covers, composites | 64321-45417 | \$275 |

VINYL NOSE & TAIL ID GRAPHIC ID KITS FOR A REALISTIC OEM LOOK!

PRINTED ON OUTDOOR DURABLE HIGH-TACK VINYL • GLOSS LAMINATED SURFACE PROVIDES EXCELLENT PROTECTION

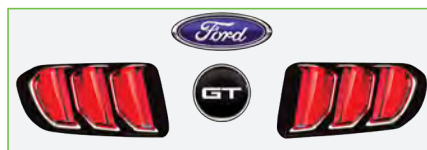

FORD MUSTANG

| | | |
|---------|-------------|------|
| Nose ID | 60321-44141 | \$52 |
| Tail ID | 64321-44541 | \$38 |

PRICING SUBJECT TO CHANGE WITHOUT NOTICE

PRO STOCK

BODY DIMENSIONS

| NO. | LOCATION | DETAILS | CHEVROLET CAMARO SS | FORD MUSTANG |
|-----|--|--|---------------------|--------------|
| 1. | Front Overhang | Measured from long side of wheelbase center to front edge of body (splitter not included) | 45.00 | 45.00 max |
| 2. | Width | Over spindle | 64.75 | 64.75 |
| 3. | Front Fascia Width | Measured across the front end at upper/outer corners of headlight recessed area | 51.00 | 30.875 |
| 4. | Windshield Length Center | Measured from top center of windshield down to rear of hood/cowl center | 20.25 min | 24.50 min |
| 5. | Overall Height | Measurement taken from the highest point of roof to rear of rocker | 44.00 min | 44.00 |
| 6. | Width (at B-Post) | Measurement taken 15" up from bottom of rocker, +/-0.25" | 65.75 | 65.00 |
| 7. | Roof Length | | 58.625 | 45.25 |
| 8. | Side Window Height | Measurement taken at tallest point | 12.125 | 14.00 |
| 9. | Door Length | Measurement taken at upper body line | 56.375 | 53.375 |
| 10. | Rear Window Length | | 27.25 | 35.75 |
| 11. | Deck Lid Length | Measurement taken from bottom of rear window center | 18.125 | 19.75 |
| 12. | Deck Lid Width | Measurement taken across rear of deck lid | 47.75 | 45.50 |
| 13. | Spoiler Length | Length does not include wicker height. Minimum 0.75" height for wicker. Must be 90° | 14.00 | 14.00 |
| 14. | Windshield Length | Measurement taken 12" inward from bottom corner of windshield. From this point, go to top of windshield, parallel to center line of body | 26.25 min | 28.50 min |
| 15. | Spill Plate Height | +/-0.125" | 6.00 | 6.00 |
| 16. | Section of Spill Plate above Spoiler | +/-0.125" | 1.00 | 1.00 |
| 17. | Spill Plate Extension past rear of Spoiler | | 2.00 max | 2.00 max |
| 18. | Width in Front of Front Tire | Measurement taken at bottom of opening. +/-0.25" | 62.50 | 62.125 |
| 19. | Width Behind Front Tire | Measurement taken 10" from front of rocker. +/-0.25" | 63.625 | 64.25 |
| 20. | Width at Front Edge of Door | Measurement taken at widest point, +/-0.25" | 65.50 | 65.25 |
| 21. | Width in Front of Rear Tire | Measurement taken at bottom of rocker. +/-0.25" | 65.75 | 65.50 |
| 22. | Width Behind Rear Tire | Measurement taken at bottom of panel, widest point, +/-0.25" | 61.50 | 60.875 |
| 23. | Width at Center of Rear Axle | +/-0.25" | 66.25 | 67.25 |
| 24. | Rear Overhang | Measurement taken from the center of the rear axle to the center of bumper at furthest point above wheelie bar opening, +/-0.25" | 48.25 | 49.25 |
| 25. | Length Left Hand Side | Measurement taken from rear of rocker to front edge of front wheel opening. +/-0.25" | 100.50 | 102.125 |
| 26. | Length Right Hand Side | Measurement taken from rear of rocker to front edge of front wheel opening. +/-0.25" | 99.125 | 100.875 |
| 27. | Wheelbase - Max | | 105.00 | 105.00 |
| 28. | Wheelbase - Min | | 104.00 | 104.00 |
| 29. | B-Post to Centerline of rear axle | +/-0.25" | 21.50 | 22.00 |
| 30. | Splitter Length | Amount of 2.375" Total length front splitter mounted in front of body (see NHRA rulebook for more info) | 0.375 | 0.375 |
| 31. | Length of Spill Plate | | 26.00 max | 26.00 max |
| 32. | B-Post Location | Measurement taken from bottom of rocker | 15.00 | 15.00 |

FIVE STAR BODIES ARE DESIGNED TO MAINTAIN PRECISE FIT WITH OPTIMIZED AERODYNAMICS!

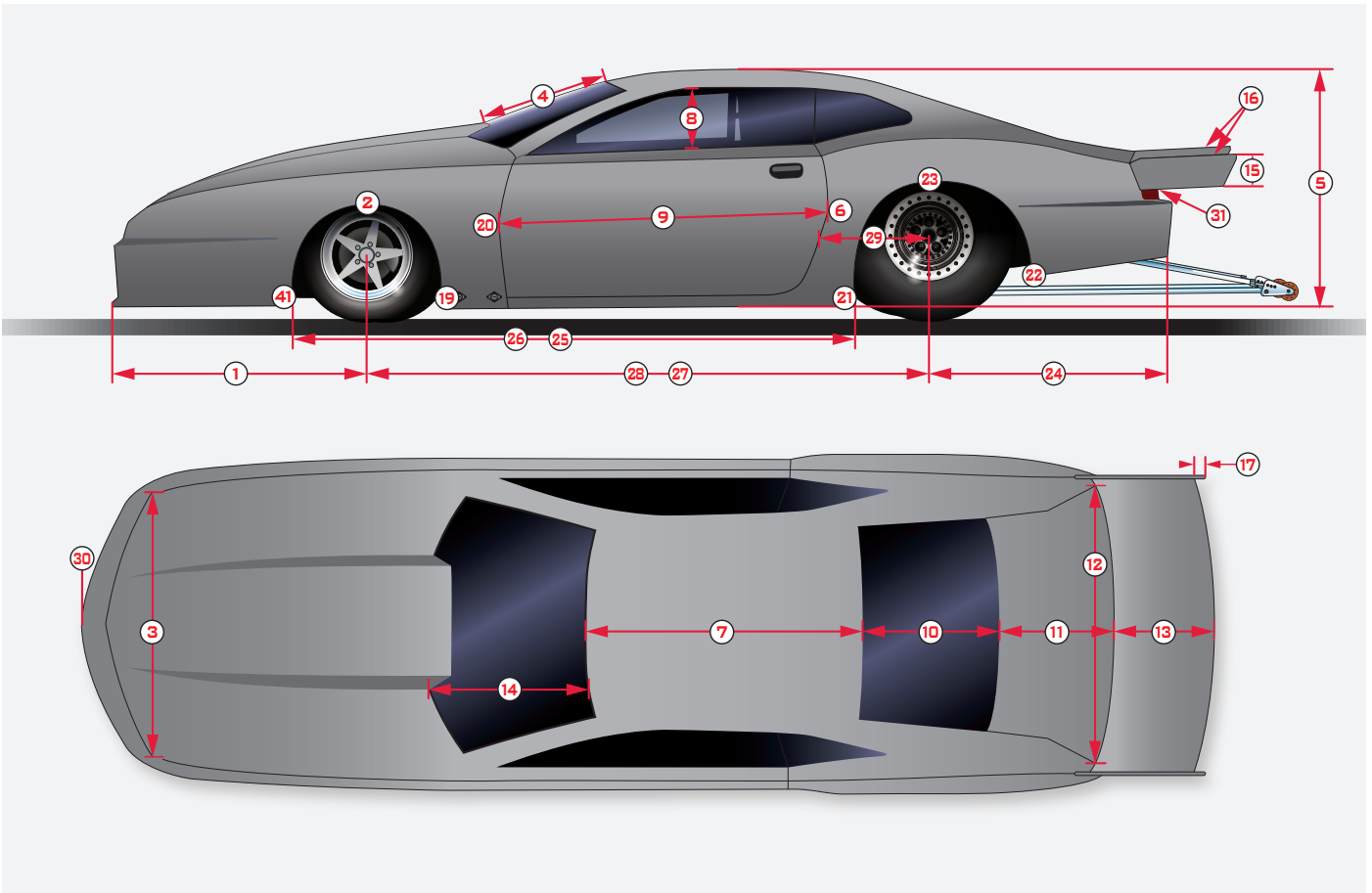

» **DOWNLOAD OFFICIAL RULEBOOK @ NHRARACER.COM**

HAVE A TECH QUESTION? THE NHRA ALSO HAS RESOURCES FOR ALL NHRA DIVISIONS TO ANSWER YOUR QUESTIONS ABOUT SAFETY, RULES & COMPLIANCE. VISIT NHRARACER.COM



TEMPLATE SETS ENSURE A CORRECT FIT FOR OPTIMUM AERODYNAMICS

- » Complete template set ensures body is installed correctly
- » Made from high-quality aluminum to maintain shape
- » Purchase complete set or Body/Nose Centerline only

| | | |
|--|-------------|-------|
| Template Set, Ford, Complete, aluminum (ADDITIONAL CRATING CHARGE FOR FREIGHT SHIPMENT) | 60321-82033 | \$834 |
| Template Set, Chevrolet, Complete, aluminum (ADDITIONAL CRATING CHARGE FOR FREIGHT SHIPMENT) | 60132-82033 | \$712 |
| Template, Nose/Body Centerline, Chevrolet, aluminum | 60132-82133 | \$331 |

****PRICING SUBJECT TO CHANGE WITHOUT NOTICE****

PRO STOCK / PRO MOD

FEATURED PRODUCTS



WINDOW INSTALLATION KIT

- » Provides the perfect fit and helps to increase the life of your window
- » Black oxide coated to prevent rust
- » This kit has enough hardware to install a complete set of windows on one car
- » Kit includes: 120 6-32 1/2" & 16 6-32 3/4" flat head socket screws, 136 6-32 nylon locknuts, 1 long-arm hex key and 9/64" drill bit

| | | |
|-------------------------|-----|------|
| Window Installation Kit | 805 | \$27 |
|-------------------------|-----|------|



VINYL NOSE & TAIL ID GRAPHIC ID KITS

Built to withstand the rigors of the racetrack, our vinyl graphics are made from high-quality materials that resist fading, cracking, and peeling. They maintain their brilliant appearance even under the harshest conditions.

- » **HIGH-TACK ADHESION:** Our outdoor high-tack vinyl ensures that your graphics stay securely in place
- » **EXTREME DURABILITY:** Gloss laminated surface provides excellent protection under the harshest conditions
- » **EASY APPLICATION:** Installing our graphics is a breeze. With our easy-to-follow application instructions and the use of professional-grade vinyl, you can achieve a smooth, bubble-free finish that looks like it was applied by a pro!
- » **ORDERING INFO** on pages 114-115

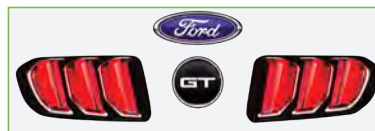

PREMIUM CARBON FIBER FLAT SHEETS

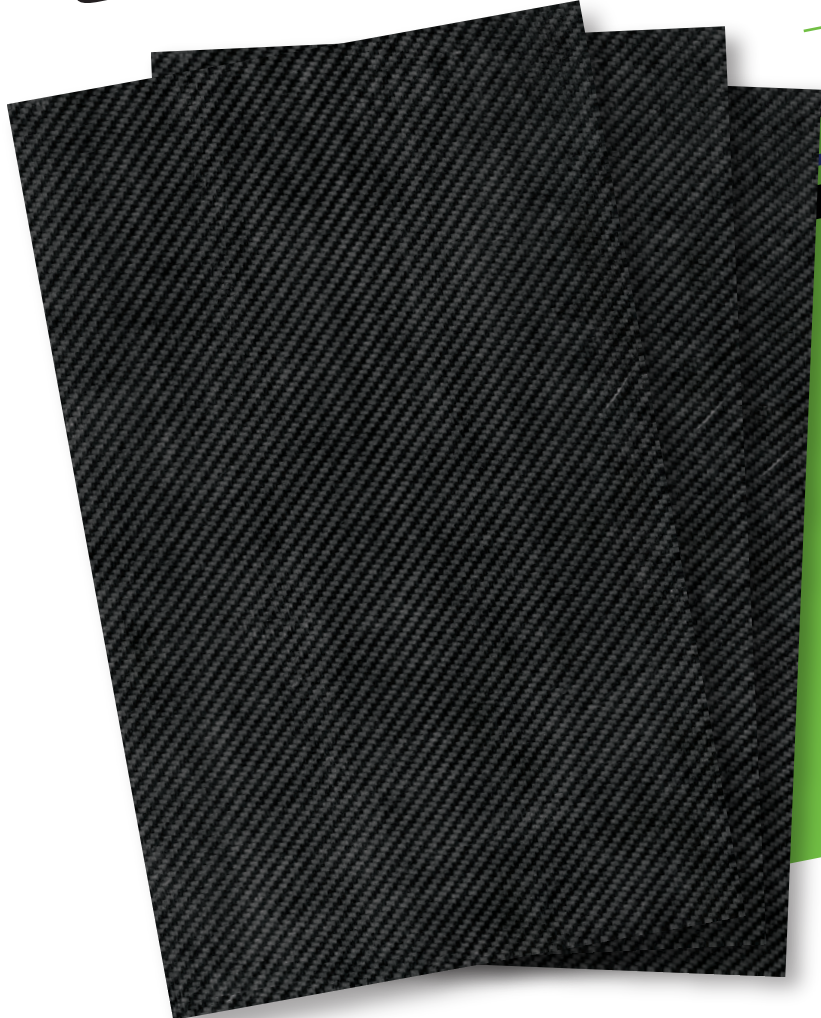

- » True cosmetic carbon fiber surface finish
- » Flat sheets allow you to custom fit your needs
- » Very high strength to weight ratio & heat tolerance
- » Excellent vibration damping characteristics
- » Laminated for additional strength & durability
- » Perfect for Interior accent panels

**2'x4' & 4'x8' FLAT SHEETS
READY TO CUT & FIT!**

STANDARD WEIGHT CARBON FIBER FLAT SHEETS

» Sheets laminated with 2 layers carbon fiber, 1 layer woven fiberglass unless otherwise noted

| | | |
|-----------|--|-------|
| 090-04412 | .040" thick, 2'x4' | \$178 |
| 090-00412 | .040" thick, 4'x8' (1 LAYER CARBON FIBER 2 LAYER WOVEN FIBERGLASS) | \$704 |
| 090-00421 | .040" thick, 4'x8' | \$761 |
| 090-00612 | .050" thick, 4'x8' | \$802 |

LIGHTWEIGHT CARBON FIBER FLAT SHEETS

» Multi-layer laminate consisting of 100% carbon fiber to create the lightest panel possible

| | | |
|-----------|--------------------|-------|
| 090-04430 | .040" thick, 2'x4' | \$213 |
| 090-00220 | .028" thick, 4'x8' | \$695 |
| 090-00430 | .040" thick, 4'x8' | \$816 |

ENGINEERED THROUGH THE DRIVER'S EYES



BODY MOUNTING TOOLS, BRACING & ACCESSORIES

PRODUCTS ESSENTIAL FOR A COMPLETE,
PROFESSIONAL LOOKING RACECAR



- » **MOUNTING TOOLS:** Ensure a professional body installation and easily replace panels throughout the season with a quick, hassle-free process
- » **UNIVERSAL BRACING:** Support body panels with these lightweight components essential to achieving astounding aerodynamics
- » **ACCESSORIES:** Everything you need to give your racecar that extra finishing touch!

FIVE STAR PREMIUM AVEX STYLE MULTI-GRIP RIVETS

- » Five Star Rivets have a super-tight grip & won't spin while drilling
- » Grip range of up to 3/16" for 1/8" rivets & up to 1/2" for 3/16" rivets
- » Use long shank rivets for fastening fender, door, & windshield post together
- » Sold in quantities of 100 & 500; large head & small head with choice of 1/8" unpainted or 3/16" unpainted, white, black, blue, or red



| SIZE/DESCRIPTION | QTY | SMALL | LARGE | |
|------------------|-----|-----------|-----------|------|
| 3/16", color | 100 | 814x-100S | 814x-100L | \$17 |
| 3/16", unpainted | 100 | 816-100S | 816-100L | \$17 |
| 3/16" long shank | 100 | 816A-100S | N/A | \$19 |
| 3/16", color | 500 | 814x-500S | 814x-500L | \$53 |
| 3/16", unpainted | 500 | 816-500S | 816-500L | \$53 |
| 1/8", unpainted | 100 | 815-100S | 815-100L | \$13 |
| 1/8", unpainted | 500 | 815-500S | 815-500L | \$48 |

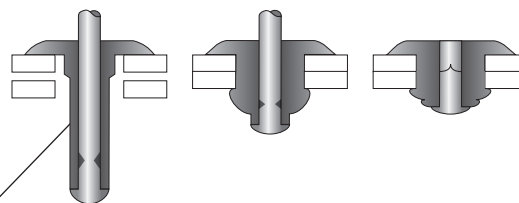

Provide a secure installation of your body panels with Five Star Rivets & Washers!

Five Star Rivets pull much tighter than other, cheaper rivets.

Washers are oversized to fit with Five Star Rivets and keep rivets tight no matter how much vibration

FIVE STAR PREMIUM WASHERS

- » Five Star Premium Washers are lightweight & available in 3 sizes
- » Recommended for all plastic & composite body panels to keep them tight & prevent rivets from pulling out

| TYPE | SIZE (I.D.) | SIZE (O.D.) | QTY | | |
|----------|-------------|-------------|-----|-----------|------|
| Standard | 1/8" | 3/8" | 100 | 817-100A | \$9 |
| Standard | 1/8" | 3/8" | 500 | 817-500A | \$25 |
| Standard | 3/16" | 1/2" | 100 | 818-100A | \$9 |
| Standard | 3/16" | 1/2" | 500 | 818-500A | \$25 |
| Large | 3/16" | 3/4" | 100 | 818-100AL | \$9 |
| Large | 3/16" | 3/4" | 500 | 818-500AL | \$25 |

HIGH-IMPACT PLASTIC WEAR STRIPS

- » Height adjustable to seal the nose to the track to optimize aero & protection from wear
- » CNC-machined from Five Star's exclusive durable plastic
- » 2-piece kit fits either side
- » Install with Five Star Universal Body Mounting Kits
- » Available in 10 colors **-W -B -CB -R -Y -OR -FG -FO -FR -FY**

| | | | |
|---|---------------|---------------|------|
| ABC NextGen, NextGen Late Model Stock Car | 116" x 1-7/8" | 11002-41551-x | \$35 |
| ABC, LMSC, Straight-up Metal, Dirt Grand National | 112" x 2-3/4" | 000-400-x | \$35 |
| S2 Sportsman | 101" x 3" | 664-400-x | \$42 |
| Classic Street Stock (N/A IN FLUORESCENT COLORS) | 120" x 5" | 600-400-x | \$41 |
| MD3 Street Stock, '88 Monte Carlo | 119" x 3" | 021-400-x | \$41 |
| Modern Style Street Stock, North American Sportsman | 107" x 3" | 20002-41551-x | \$38 |



11002-41551-X

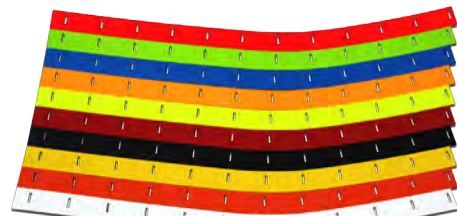

000-400-X



11002-41551-Y YELLOW WEAR STRIPS FULLY INSTALLED WITH 00001-72651 UNIVERSAL BODY MOUNTING KIT

KITS SPEED UP WEAR STRIP INSTALLATION & ALLOW FOR ADJUSTABILITY OF WEAR STRIP IF NEEDED



FULLY ASSEMBLED PLASTIC

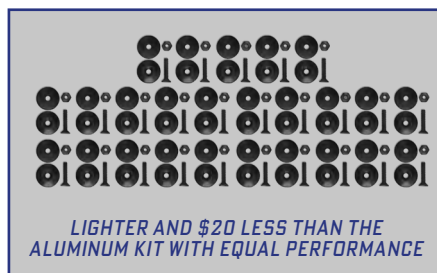

LIGHTER AND \$20 LESS THAN THE ALUMINUM KIT WITH EQUAL PERFORMANCE



FULLY ASSEMBLED ALUMINUM

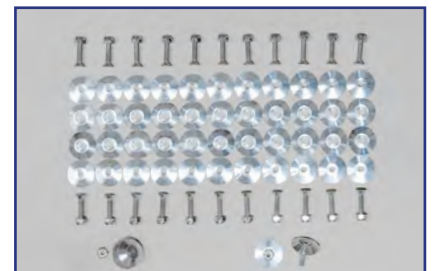

UNIVERSAL BODY MOUNTING KITS

- » Universal fit that can be used anywhere on a racecar
- » Plastic Kit comes in all black & features Delrin washers that withstand repeated impact & stress
- » **Aluminum Kit includes:** 25 lightweight machined aluminum inner & outer 1" diameter washers, 25 nuts & 25 bolts. Kit weighs 12 oz
- » **Plastic Kit includes:** 25 ultra-durable plastic inner & outer 1" diameter washers, 25 lightweight aluminum nuts & 25 bolts. Kit weighs 7 oz

| | | |
|---------------------------------------|-------------|------|
| Aluminum: 25 sets (FULL INSTALLATION) | 000-400K | \$49 |
| Plastic: 25 sets (FULL INSTALLATION) | 00001-72651 | \$29 |

PRICING SUBJECT TO CHANGE WITHOUT NOTICE

FRONT BUMPERS

- » Formed using CNC progressive tube bending technology
- » Fits the exact contour of Five Star noses for maximum protection and ease of installation
- » Formed from 1-3/4" OD round steel tubing
- » For a complete secure mount, it is recommended to install your bumpers with Five Star's Front Bumper Mounting Kits

| ABC NEXTGEN | | |
|--|-------------|------|
| Front, .065" steel | 11002-71182 | \$48 |
| Front, .095" steel | 11002-71185 | \$48 |
| Front, .095" steel (12" EXT RIGHT SIDE) | 11002-71188 | \$56 |
| NEXTGEN LATE MODEL STOCK CAR | | |
| Front, .065" steel | 13002-71182 | \$48 |
| Front, .095" steel | 13002-71185 | \$48 |
| Front, .095" steel (12" EXT RIGHT SIDE) | 13002-71188 | \$56 |
| ORIGINAL ABC / ORIGINAL LMSC / STRAIGHT-UP METAL | | |
| Front, .065" steel | 660-7103 | \$48 |
| Front, .095" steel | 660-7103B | \$48 |
| Front, .095" steel (12" EXT RIGHT SIDE) | 660-7103C | \$56 |

| NORTH AMERICAN SPORTSMAN | | |
|--|-------------------|------|
| Front .065" steel | 20002-71182 | \$48 |
| STREET STOCK '88 MONTE CARLO | | |
| Front, .065" steel | 600-7103 | \$48 |
| Front, .095" steel | 600-7103B | \$48 |
| Front, .065" steel | 600-7101 (SQUARE) | \$48 |
| STREET STOCK MD3 CAMARO, MUSTANG & CAMRY | | |
| Front, .065" steel | 20002-71182 | \$48 |
| DIRT GRAND NATIONAL | | |
| Front, .065" steel | 700-7103 | \$48 |
| Front, .095" steel | 700-7103B | \$48 |
| SHORT TRACK TRUCK COMMON | | |
| Front, .065" steel | 21001-71162 | \$48 |

**FRONT BUMPER MOUNTING KIT (HIGHLIGHTED IN ORANGE)
WITH BLACK ADJUSTABLE BUMPER SUPPORTS**



.095" STEEL BUMPER WITH
12" EXTENSION FOR
ADDITIONAL RIGHT FRONT
PROTECTION

NEW!
LIGHTWEIGHT EXTRUDED ALUMINUM



CLOSE-UP OF
ADJUSTABLE
BUMPER SUPPORT

FRONT BUMPER MOUNTING KITS

- » Everything you need to mount the bumper to the chassis
- » Upgraded lightweight, extruded, black anodized aluminum adjustable bumper supports
- » Make quick, easy, & accurate adjustments with a 5/8" wrench
- » Universal design for all Five Star Short Track Noses
- » Fits all chassis configurations
- » **Complete Kit includes:** 2 aluminum threaded bumper support tubes; 4 clevis, eye bolts & nuts; 2 1-1/2" pieces of square tubing, notched on one end; 2 pieces of flat stock; 4 1-1/2" bolts & stover nuts, 2 pivoting chassis mounts with 2-1/2" bolts & nuts
- » **Adjustable Bumper Support Kit includes:** 2 extruded, threaded, black anodized aluminum adjustable tubes; 4 eye bolts & nuts; 4 1-1/2" bolts and stover nuts
- » **Replacement Kit includes:** 2 1-1/2" square pieces of square tubing; 2 pieces of flat stock; 1/2" nuts & bolts & mounting tabs

| | | |
|-------------------------------|-------------|-------|
| Complete Kit | 10001-72721 | \$132 |
| Adjustable Bumper Support Kit | 10001-72733 | \$35 |
| Replacement Kit | 802-4 | \$87 |

10001-72721 | COMPLETE KIT

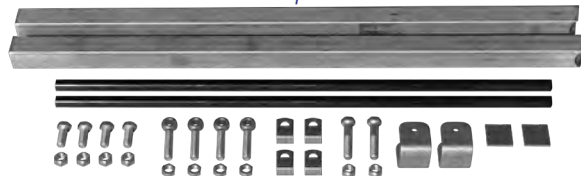

10001-72733 | ADJUSTABLE BUMPER SUPPORTS KIT



802-4 | REPLACEMENT KIT



HOOD PIN BRACKETS

- » Preformed to fit the nose & hood precisely
- » Aluminum option weighs less than half of steel option
- » Both options include welded-on tabs for hood pin placement
- » Aluminum bracket includes welded on mounting tabs on each end to brace to the front bumper mounting kit for added support
- » ABC NextGen / NextGen Late Model Stock Car require 4 hood pins & Older Style ABC and Older Style LMSC require 5 hood pins
- » Available in 1/2" & 3/4" options, & will work with both 1/2" & 3/8" hood pins

| ABC NEXTGEN / NEXTGEN LATE MODEL STOCK CAR | | |
|--|--------------|------|
| 3/4" OD, aluminum (COMMON) | 11002-34333 | \$66 |
| 3/4" OD, steel (COMMON) | 11002-34331 | \$35 |
| ORIGINAL ABC / ORIGINAL LATE MODEL STOCK CAR | | |
| 3/4" OD, aluminum (EXCLUDES FORD) | 660-411A-HPB | \$66 |
| 3/4" OD, aluminum (FORD) | 570-411A-HPB | \$66 |
| 3/4" OD, steel (EXCLUDES FORD) | 660-411-HPB | \$35 |
| 3/4" OD, steel (FORD) | 570-411-HPB | \$35 |
| 1/2" OD, steel (EXCLUDES FORD) | 660-410-HPB | \$35 |
| 1/2" OD, steel (FORD) | 570-410-HPB | \$35 |
| NORTH AMERICAN SPORTSMAN | | |
| 3/4" OD, steel | 20002-34331 | \$35 |

| S2 SPORTSMAN | | |
|--|-------------|------|
| 3/4" OD, steel | 664-411-HPB | \$35 |
| 1/2" OD, steel | 664-410-HPB | \$35 |
| SHORT TRACK TRUCK | | |
| 1/2" OD, steel (COMMON) | 21001-34131 | \$35 |
| STREET STOCK | | |
| 3/4" OD, steel ('88 MONTE CARLO) | 600-410-HPB | \$35 |
| 3/4" OD, steel (CAMARO, MUSTANG & CAMRY) | 20002-34331 | \$35 |
| DIRT GRAND NATIONAL | | |
| 1/2" OD, steel (EXCLUDES FORD) | 700-410-HPB | \$35 |
| 1/2" OD, steel (FORD) | 703-410-HPB | \$35 |

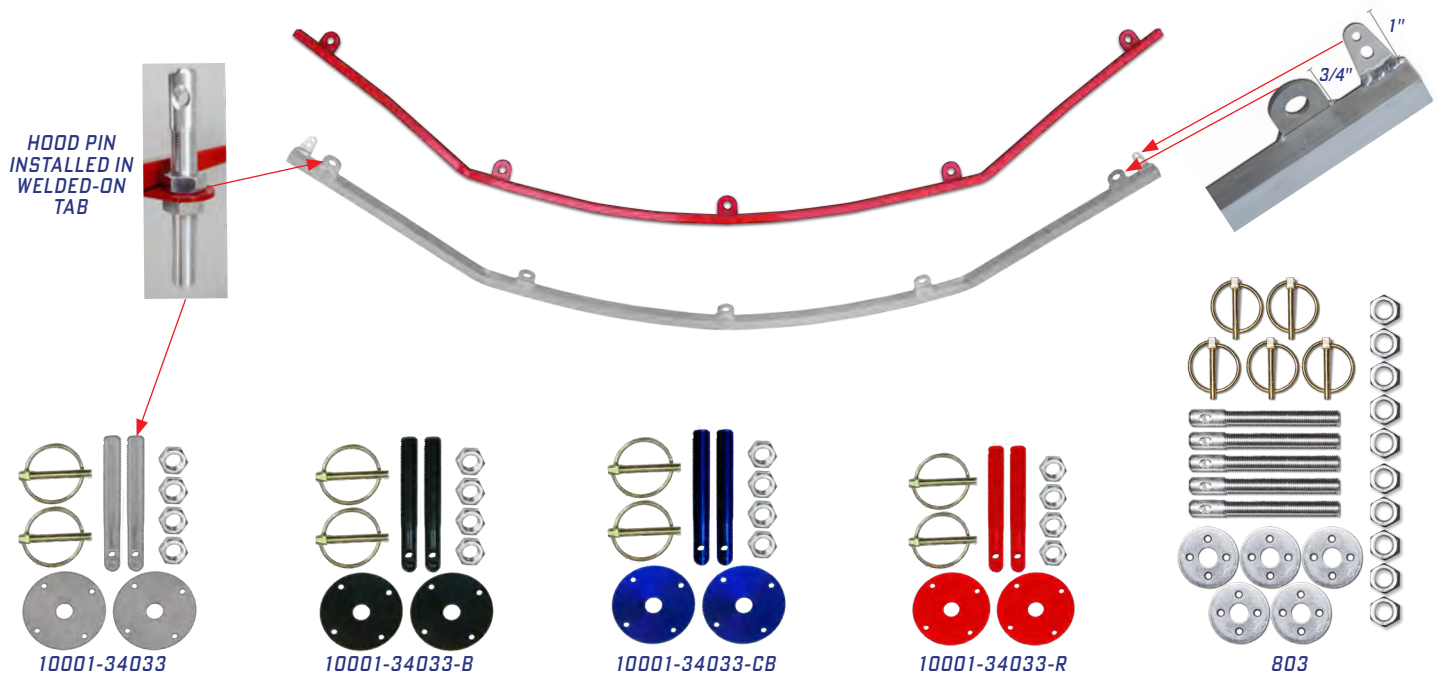

HOOD PIN KITS

- » **Secure your hood in style!**
- » 3/8" Hood Pin Kit: 2 pack kit includes: 2 lightweight anodized & gun-drilled aluminum pins (half the weight of standard), 2 aluminum scuff plates, 2 flip-over steel clips, 4 jam nuts
- » 1/2" Hood Pin Kit: 5 pack kit includes: 5 lightweight aluminum pins, 5 aluminum scuff plates, 5 flip-over style steel clips, 10 jam nuts

| | | |
|----------------------------|----------------|------|
| 3/8" Hood Pin Kit, Silver | 10001-34033 | \$16 |
| 3/8" Hood Pin Kit, Black | 10001-34033-B | \$16 |
| 3/8" Hood Pin Kit, Blue | 10001-34033-CB | \$16 |
| 3/8" Hood Pin Kit, Red | 10001-34033-R | \$16 |
| 1/2" Hood Pin Kit, 5 pack | 803 | \$38 |
| 1/2" Scuff Plate, aluminum | 803-PS | \$2 |

PRICING SUBJECT TO CHANGE WITHOUT NOTICE

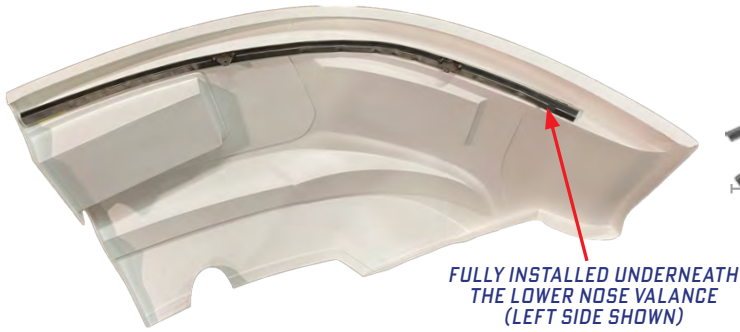

FULLY INSTALLED UNDERNEATH THE LOWER NOSE VALANCE (LEFT SIDE SHOWN)



ALUMINUM
11002-75733

42-1/2"

LOWER NOSE SUPPORT BRACKET

- » Mounts under the lower valance to maintain strength & structural integrity for the nose under high speeds
- » Choose from lightweight aluminum or steel bracket
- » Fits left & right half of nose
- » **2-piece kit includes: 2 brackets with 2 attached mounting tabs for ease of installation**

| | | |
|----------|-------------|------|
| Aluminum | 11002-75733 | \$49 |
| Steel | 11002-75731 | \$44 |

FITS THESE BODY STYLES: ABC NEXTGEN AND NEXTGEN LATE MODEL STOCK CAR



000-500: MOUNT TO INSIDE OF WEAR STRIPS WITH A FIVE STAR UNIVERSAL BODY MOUNTING KIT



11002-75333: MOUNT VERTICALLY ON NOSE SIDE

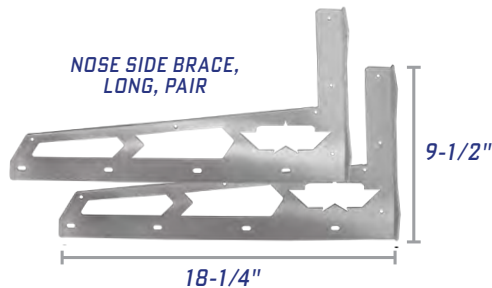

NOSE SIDE BRACE,
LONG, PAIR

9-1/2"

18-1/4"

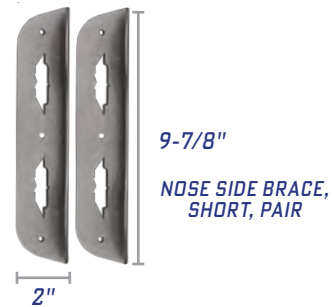

9-7/8"

NOSE SIDE BRACE,
SHORT, PAIR

2"

ALUMINUM NOSE SIDE BRACES

- » Provides structure to an aero critical part of the car
- » Laser-cut aluminum is pre-drilled for riveting to the nose & for mounting body braces
- » Works great with Five Star's Premium Adjustable Body Braces (PN 10001-759XX ON PAGE 165)
- » Each pair weighs less than a pound

| | | |
|-----------------------------|---------|------|
| Nose Side Brace, Long, pair | 000-500 | \$39 |
|-----------------------------|---------|------|

FITS THESE BODY STYLES: OLDER STYLE ABC AND OLDER STYLE LMSC, FIBERGLASS SPORTSMAN, STRAIGHT UP METAL, DIRT GRAND NATIONAL, MINI STOCK MUSTANG

| | | |
|------------------------------|-------------|------|
| Nose Side Brace, Short, pair | 11002-75333 | \$15 |
|------------------------------|-------------|------|

FITS THESE BODY STYLES: ABC NEXTGEN, NORTH AMERICAN SPORTSMAN, NEXTGEN LATE MODEL STOCK CAR, SHORT TRACK TRUCK



FULLY INSTALLED 11002-73333

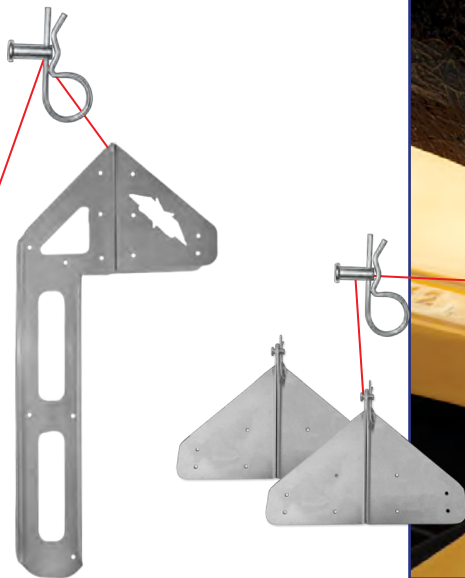

FULLY INSTALLED 000-33H

ALUMINUM HOOD HINGE KITS

- » Hinged hoods create easy access to the engine compartment
- » Long Hinge Kit includes: Laser cut aluminum hinge, pin, & clip assembly. 1 kit is required to complete the installation of a hood
- » Short Hinge Kit includes: Laser cut aluminum hinge, pin, & clip assembly. 2 kits are required to complete the installation of a hood

| | | |
|------------------------|-------------|------|
| Hood Hinge, short | 000-33H | \$17 |
| Hood Hinge, long | 11002-73333 | \$39 |
| Replacement Pin & Clip | 000-33HP | \$5 |

ALUMINUM HOOD PROP

- » Makes for the easiest access to the engine compartment
- » Made of machined lightweight aluminum
- » Used for hinged hoods
- » Sold as a pair, 2 needed for installation

| | | |
|-----------------|----------|------|
| Hood Prop, pair | 000-3400 | \$67 |
|-----------------|----------|------|



FULLY INSTALLED 000-3400



000-409 FULLY INSTALLED



STREET STOCK
FLEXIBLE RADIATOR DUCT

FLEXIBLE RADIATOR DUCTS

- » Retains air flow functionality even after frontal impact & reduces the risk of radiator damage
- » Flexible Radiator Duct replaces rigid metal ductwork with a custom canvas bag & aluminum or plastic framing
- » Long lasting & durable
- » Simple installation
- » Select your model by measuring the size of the radiator core
- » Features molded plastic radiator mounting flanges
- » Plastic Nose Air Inlet Extension (PN 000-409-NP) used for 000-409 Radiator Ducts only

Street Stock (PN 600-409)

- » Fits both '88 Monte Carlo Noses
- » Captures air from both the upper & lower nose grill openings

| ABC/NORTH AMERICAN SPORTSMAN/S2/SU | | STYLE/SIZE | ABC NEXTGEN/NEXTGEN LMSC | |
|------------------------------------|-------|----------------------------|--------------------------|-------|
| 000-409-1 | \$169 | Griffin, 22-3/8" x 17-7/8" | 11002-42120 | \$135 |
| 000-409-2 | \$169 | Howe, 24-1/4" x 18-1/2" | 11002-42121 | \$135 |
| 000-409-3 | \$169 | Howe, 22-1/4" x 18-3/4" | 11002-42122 | \$135 |
| 000-409-4 | \$169 | C & R, 22-1/4" x 17-3/4" | 11002-42123 | \$135 |
| 000-409-5 | \$169 | C & R, 24-1/4" x 17-3/4" | 11002-42124 | \$135 |
| 000-409-6 | \$169 | Howe, 27-1/4" x 18-1/2" | 11002-42125 | \$135 |
| LMSC | | STYLE/SIZE | STREET STOCK | |
| 000-409-5 | \$169 | C & R, 24-1/4" x 17-3/4" | 600-409-2 | \$156 |
| 000-409-6 | \$169 | Howe, 27-1/4" x 18-1/2" | 600-409-6 | \$156 |

PLASTIC BRAKE DUCT KIT

- » Provide peak airflow to cool your brakes
- » Universal fit for all noses at correct angle; fits either side
- » Fits 3" & 4" Brake Duct hose
- » Crimped 3/16" stainless steel screen to keep debris out
- » Kit includes: pre-cut stainless steel screen, rivets & washers
- » Weighs 6 oz

Brake Duct Kit 000-412D \$35

FITS THESE BODY STYLES: ABC NEXTGEN, ABC, NEXTGEN LMSC, LMSC, S2, SHORT TRACK TRUCK, NORTH AMERICAN SPORTSMAN, STRAIGHT-UP METAL, STREET STOCK



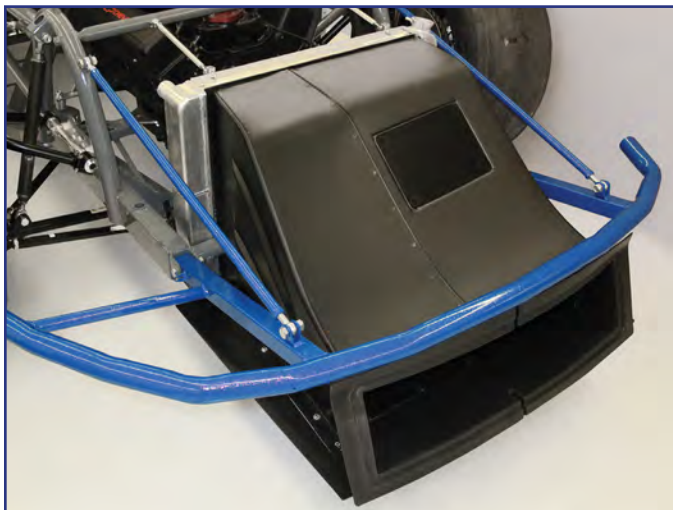

000-408 FULLY INSTALLED

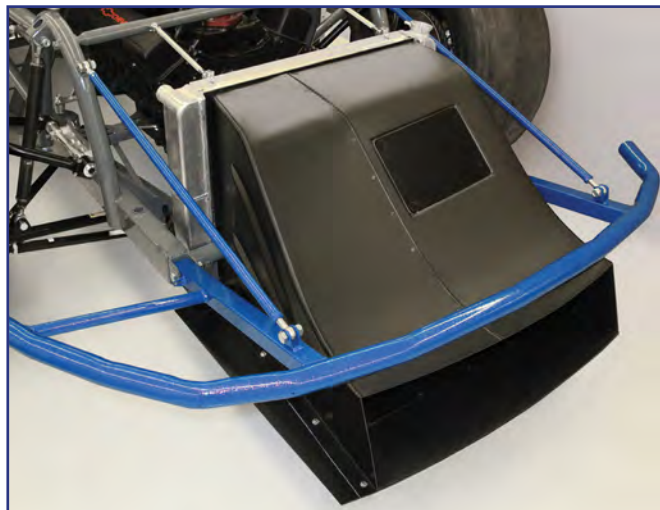

11002-42151 FULLY INSTALLED

MOLDED PLASTIC RADIATOR DUCTS

- » Universal multi piece design for easy installation to fit any chassis and radiator size/offset
- » High air flow design
- » Premium molded plastic weighs less than 13 lbs
- » More durable and easier to install than other sheet metal air boxes
- » 100% positive seal from nose to radiator
- » Access panel for easy debris clean-out
- » **Kit includes:** 2-piece molded plastic radiator duct, 1 molded plastic bottom, 1 aluminum cover kit with 4 black rivets, 1 plastic nose air inlet extension, and 1 molded plastic frame *(THE PLASTIC NOSE AIR INLET EXTENSION IS FOR THE UNIVERSAL SHORT TRACK BODY. IT IS NOT NEEDED FOR ABC NEXTGEN AND NEXTGEN LATE MODEL STOCK CAR)*

| | | |
|--|---|-------|
| Universal Short Track Bodies* | 000-408 | \$221 |
| ABC NextGen / NextGen Late Model Stock Car | 11002-42151 <i>(AIR INLET EXTENSION NOT REQUIRED)</i> | \$185 |
| Radiator Duct, 2-piece | 000-408-D | \$68 |
| Radiator Duct, Bottom | 000-408-B | \$54 |
| Radiator Duct, Cover Kit | 000-408-A | \$15 |
| Radiator Duct, Frame | 000-408-R | \$36 |

*FITS THESE BODY STYLES: OLDER STYLE ABC, OLDER STYLE LMSC, NORTH AMERICAN SPORTSMAN, S2 SPORTSMAN, STRAIGHT-UP METAL, STREET STOCK



PLASTIC NOSE AIR INLET EXTENSION

- » Ideal for racers who build their own aluminum radiator box
- » Molded Plastic construction weighs less than 2 lbs
- » The Plastic Nose Air Inlet Extension is not needed for the ABC NextGen & NextGen Late Model Stock Car
- » Item already included with 000-408 Molded Plastic Radiator Duct & 000-409 Flexible Radiator Duct

| | | |
|----------------------------------|------------|------|
| Plastic Nose Air Inlet Extension | 000-409-NP | \$36 |
|----------------------------------|------------|------|

FITS THESE BODY STYLES: ABC, LMSC, NORTH AMERICAN SPORTSMAN, S2 SPORTSMAN, STRAIGHT-UP METAL



SHOWN MOUNTED FROM INSIDE OF NOSE



PRICING SUBJECT TO CHANGE WITHOUT NOTICE

COWL INDUCTION COLD AIR BOXES

FLOW BENCH TESTED FOR PEAK AIRFLOW

- » Advanced lightweight composite construction with flame retardant gray resin
- » Comparable in weight to carbon fiber alternatives
- » Designed for maximum airflow using air filters as short as 3"
- » Increased distributor & under hood clearance
- » Fits a standard 14" filter element

| | | |
|-------------------------------|-------------|-------|
| 4 Barrel, 0° Angle (Offset) | 10001-53401 | \$564 |
| 4 Barrel, 3° Angle (Standard) | 10001-53431 | \$564 |
| 2 Barrel, standard | 10001-53201 | \$426 |
| 2 Barrel, offset | 10001-53202 | \$406 |

NOTE: FOR OLDER STYLE 51-SERIES COLD AIR BOXES CALL FIVE STAR 262.877.2171



FULLY INSTALLED COLD AIR BOX



2 BARREL COLD AIR BOX

4 BARREL AIR BOXES:

- » Available in 0° & 3° to ensure a proper, level fit
- » Feature a patented machined adapter ring for clean airflow, better fit, & durability
- » 3° Air box is commonly used for short track late models
- » How to determine air box angle option:
 - » Set car at proper ride height
 - » Place angle finder on carburetor to determine which air box option fits best



4 BARREL COLD AIR BOX

2 BARREL OFFSET AIR BOX:

- » Offset 2-barrel air box is for engines with a larger setback
- » Designed to allow the element to be flat across the back for engine setback & clearance in the cowl
- » Fits a standard 3-1/2" x 14" filter element

2 BBL AIR BOX IS DYNO TESTED

"The results were outstanding! Five Star's 2bbl Air Box was 10 HP & 16 ft lbs of torque better than the old one!"

-SHANE HARDING
HARDING MOTORSPORTS CHASSIS

PATENTED FLOW DESIGN 4 BBL UNIQUE HIGH FLOW DESIGN

CNC-machined aluminum ring (laminated into the air box) fits perfectly on carburetor to maximize airflow

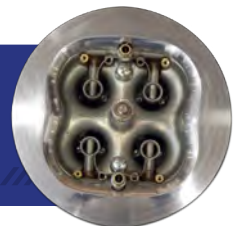

SCAN HERE TO  SHOP ONLINE

» FOR INDIVIDUAL PART DIMENSIONS, VISIT FIVESTARBODIES.COM

REFLECTIVE HEAT SHIELD

- » Thin reflective adhesive film reflects over 90% of radiant heat from the engine, up to 500°F
- » Easy to cut and install to protect any part of the racecar from high heat:
 - » All Cold Air Boxes
 - » Foot Boxes
 - » Fuel Filter Housings
 - » Interiors
 - » Shock Canisters
 - » And more

| | | |
|--------------------------|----------|------|
| Cold Air Box Kit, 4 oz | 000-52HS | \$74 |
| 5'x26" Sheet, 3oz per ft | 000-5HS | \$74 |



FULLY INSTALLED
COLD AIR BOX KIT
000-52HS

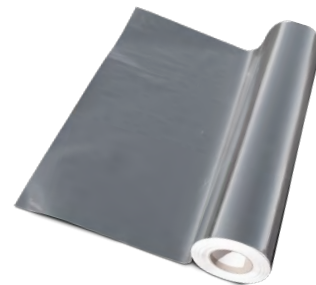

5' LENGTH X 26" WIDE SHEETS
000-5HS

COWL AIR INSERT

- » Designed for maximum airflow directly into the cold air box
- » Made of Ultraglass composite and oversized for left and right adjustment to properly fit the air box
- » Opening meets all sanctioning regulations
- » Included with ABC Body Packages
- » Available in 4 colors

| | | | |
|-----------------|-------------|--------------|---------------|
| | | -W -B | -CB -R |
| Cowl Air Insert | 661-5100A-X | \$72 | \$75 |

FITS THESE BODY STYLES: ABC NEXTGEN, ABC, NORTH AMERICAN SPORTSMAN, S2, STRAIGHT-UP METAL, SHORT TRACK TRUCK



COWL AIR DEFLECTORS

- » Smoothly flows air from cowl air opening into cold air box
- » Black Ultraglass Composite
- » Rounded Bottom: 20" x 7", Square Bottom: 20-1/8" x 7-1/2"
- » Fits all air box styles listed on page 154
- » 000-5100A-B available & fits older style 51-series air boxes

| | | |
|----------------|-------------|------|
| Rounded Bottom | 000-5200A | \$59 |
| Square Bottom | 000-5100A-B | \$76 |

ROUNDED BOTTOM | 000-5200A



SQUARE BOTTOM | 000-5100A-B



ALUMINUM COWL BRACKET TABS

- » Create a positive seal by holding hood flat at the cowl
- » Mounts along front flange of cowl panel
- » Fits 3/8" or 1/2" hood pins
- » Kit is included with cowl panels
- » Kit includes: 4 laser-cut aluminum tabs weighing 0.5 oz each

| | | |
|-------------------|---------|------|
| Cowl Bracket Tabs | 000-510 | \$13 |
|-------------------|---------|------|



REAR BUMPERS

- » Formed using CNC progressive tube bending technology
- » Fits the exact contour of Five Star bumper covers for maximum protection and ease of installation
- » Formed from 1-3/4" OD round steel tubing
- » For a complete secure mount, it is recommended to install your bumpers with Five Star's Rear Bumper Mounting Kits

| | | |
|---|-------------|------|
| ABC NextGen, .065" steel | 11002-71682 | \$48 |
| NextGen Late Model Stock Car, .065" steel | 11002-71682 | \$48 |
| ABC / LMSC / Straight-Up Metal, .065" steel | 570-7503 | \$48 |
| North American Sportsman, .065" steel | 11002-71682 | \$48 |

| | | |
|---|-----------|------|
| Street Stock '88 Monte Carlo, .065" steel | 600-7501 | \$48 |
| Dirt Grand National, .065" steel | 570-7503 | \$48 |
| Short Track Truck, .065" steel | T000-7503 | \$48 |

**REAR BUMPER FULLY INSTALLED WITH HEIGHT ADJUSTABLE MOUNTING KIT
(HIGHLIGHTED IN ORANGE)**

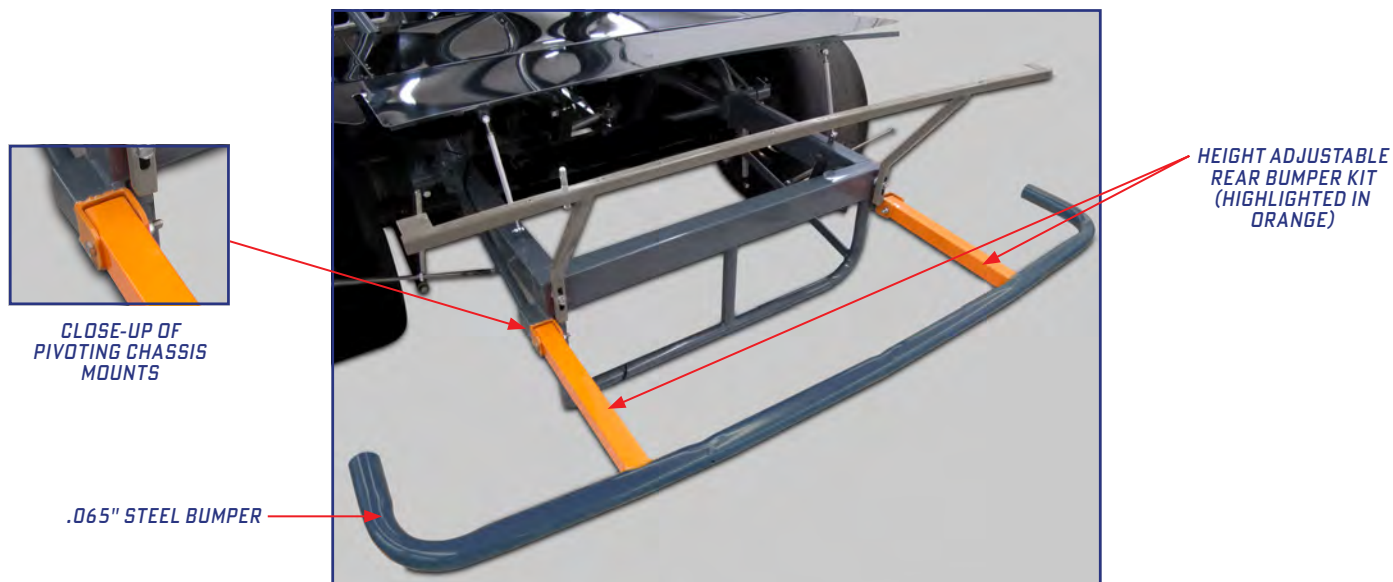

REAR BUMPER MOUNTING KITS

- » Everything you need to mount the bumper to the chassis
- » Universal design for all Five Star Short Track Bumper Covers
- » Fits all chassis configurations
- » Available in two options:
- » **Height-Adjustable Kit: (PN 802-2S)** Allows for several different mounting options and pivots to allow precise adjustments to the height of the rear bumper cover
Kit includes: 2 pivoting chassis mounts; 1 36" long 1-1/2" square piece of tubing; 2 pieces of flat stock; 2 1/2" nuts and bolts
- » **Non-Adjustable Kit: (PN 802-2)** Make your bumper a bolt-on component
Kit includes: 2 3' long x 1-3/4" thick pieces of round tubing, 2 pieces of .120" thick square tubing and 5/16" hex bolts & nuts

| | | |
|-----------------------|--------|------|
| Height-adjustable Kit | 802-2S | \$49 |
| Non-adjustable Kit | 802-2 | \$43 |

STEEL REAR DECK MOUNTING KIT

- » Everything you need to properly fabricate a perfect fitting brace from the rear bumper cover & deck lid to the chassis
- » **Deck Lid Bracket:** (PN 660-450-DLB) supports your rear body clip by securing it to the rear bumper cover & quarter panel.
Kit includes: 2 tabs for hood pins; weighs 36 oz
- » **Deck Lid Height Slider Kit:** (PN 802-3) allows for easy adjustment of spoiler height with 3-1/2" of deck lid height adjustability.
Kit includes: 2 pieces slotted 3/4" square tubing, 3/8" hex bolts & nuts
- » **Deck Lid Hold-down Kit:** (NOT SOLD SEPARATELY) allows for a removable deck lid.
Kit includes: 1 aluminum deck lid hold-down strip, 2 mounting tabs, 4 jam nuts, 2 3/8" gun-drilled, anodized aluminum pins & scuff plates (SILVER), & 2 flip-over steel clips

| | | |
|---|---------------|------|
| Rear Deck Mounting Kit* | 660-450-RDK | \$89 |
| Replacement Deck Lid Bracket* | 660-450-DLB | \$32 |
| Replacement Deck Lid Height Slider Kit* | 802-3 | \$19 |
| Replacement Deck Lid Hold-Down Strip | XM 000-310H-X | |
| Replacement Deck Lid Hold-Down Hardware Kit | XA 000-310H-K | |

FITS THESE BODY STYLES: ABC NEXTGEN, ABC, NEXTGEN LMSC, LMSC, NORTH AMERICAN SPORTSMAN, S2, STRAIGHT-UP METAL, STREET STOCK, DIRT GRAND NATIONAL, MINI STOCK

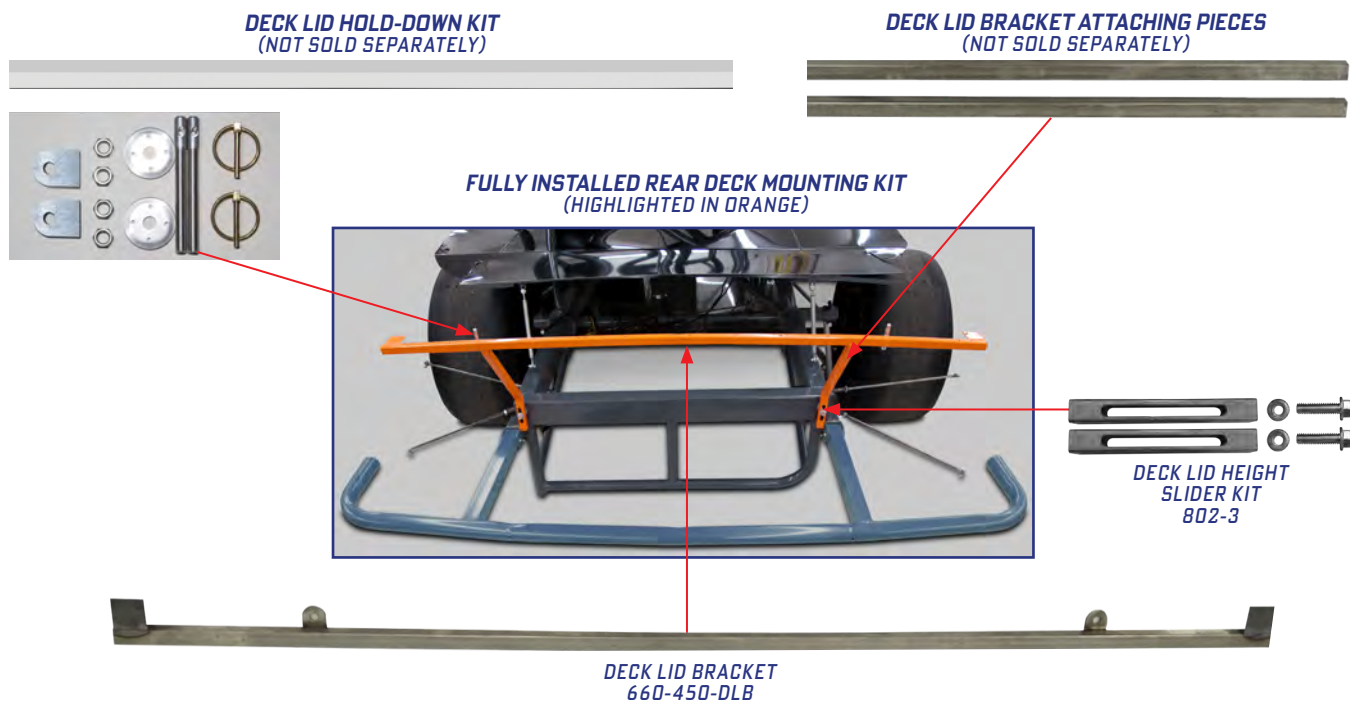

ONLY WEIGHS 17 OZ
LESS THAN HALF THE WEIGHT OF STEEL



ALUMINUM DECK LID BRACKET

- » This is a premium upgrade from the steel deck lid bracket to save weight without sacrificing strength
- » Mounts to the rear bumper cover and quarter panel, includes 2 tabs for hood pins and 4 tabs for chassis mounting options
- » Complete the combination with our 3/8" Hood Pin Kit (PN 10001-34033-X)

| | | |
|---------------------------|-------------|------|
| Aluminum Deck Lid Bracket | 11002-75633 | \$49 |
|---------------------------|-------------|------|

FITS THESE BODY STYLES: ABC NEXTGEN, ABC, NEXTGEN LMSC, LMSC, NORTH AMERICAN SPORTSMAN, S2, STRAIGHT-UP METAL, STREET STOCK, DIRT GRAND NATIONAL, MINI STOCK

REPLACEMENT SPOILER BRACKETS & BLADES

- » 2-piece polycarbonate blade with 2-piece aluminum bracket, your choice of unpainted or black powder-coated
- » Available in 90, 70 and 55 degree angles

| ABC NextGen / NA Sportsman | 5" (90°) | | 5" (70°) | | 6-1/2" (90°) | | 6-1/2" (70°) | | | | | |
|---|----------------|----------------|----------------|----------------|----------------|----------------|----------------|----------------|--------------|-------------|--------------|-------------|
| Brackets, replacement, aluminum, 60" | 11002-47369-1 | 11002-47367-1 | 11002-47369-1 | 11002-47367-1 | 11002-47369-1 | 11002-47367-1 | 11002-47369-1 | 11002-47367-1 | | | | |
| Brackets, replacement, aluminum, 64-1/2" | 11002-47389-1 | 11002-47387-1 | 11002-47389-1 | 11002-47387-1 | 11002-47389-1 | 11002-47387-1 | 11002-47389-1 | 11002-47387-1 | | | | |
| Brackets, replacement, aluminum, black, 60" | 11002-47369-1B | 11002-47367-1B | 11002-47369-1B | 11002-47367-1B | 11002-47369-1B | 11002-47367-1B | 11002-47369-1B | 11002-47367-1B | | | | |
| Brackets, replacement, aluminum, black, 64-1/2" | 11002-47389-1B | 11002-47387-1B | 11002-47389-1B | 11002-47387-1B | 11002-47389-1B | 11002-47387-1B | 11002-47389-1B | 11002-47387-1B | | | | |
| Blades, replacement, polycarbonate, 60" | 11002-47359-2 | 11002-47357-2 | 11002-47359-2 | 11002-47357-2 | 11002-47359-2 | 11002-47357-2 | 11002-47359-2 | 11002-47357-2 | | | | |
| Blades, replacement, polycarbonate, 64-1/2" | 11002-47479-2 | 11002-47477-2 | 11002-47479-2 | 11002-47477-2 | 11002-47479-2 | 11002-47477-2 | 11002-47479-2 | 11002-47477-2 | | | | |
| ABC / S2 / Straight-Up Metal | 5" (90°) | | 5" (70°) | | 5" (55°) | | 6-1/2" (90°) | | 6-1/2" (70°) | | 6-1/2" (55°) | |
| Brackets, aluminum | 661-6739-1 | 661-6737-1 | 661-6735-1 | 661-6739-1 | 661-6737-1 | 661-6735-1 | 661-6739-1 | 661-6737-1 | 661-6735-1 | 661-6739-1 | 661-6737-1 | 661-6735-1 |
| Brackets, aluminum, black | 661-6739-1B | 661-6737-1B | 661-6735-1B | 661-6739-1B | 661-6737-1B | 661-6735-1B | 661-6739-1B | 661-6737-1B | 661-6735-1B | 661-6739-1B | 661-6737-1B | 661-6735-1B |
| Blades, polycarbonate | 661-6749-2 | 661-6747-2 | 661-6745-2 | 661-6739-2 | 661-6737-2 | 661-6735-2 | 661-6739-2 | 661-6737-2 | 661-6735-2 | 661-6739-2 | 661-6737-2 | 661-6735-2 |



UNPAINTED BRACKETS WITH BLADES



BLACK POWDER-COATED BRACKETS WITH BLADES, FULLY INSTALLED USING 807-3 ADJUSTABLE BODY BRACES (SOLD SEPARATELY, SEE PG XXX)



SPOILER IS FULLY INSTALLED ON THE BUMPER COVER USING THE SPOILER MOUNTING KIT

ALUMINUM SPOILER MOUNTING KIT

- » Everything needed to mount the polycarbonate spoiler blade to the bracket, & the bracket to the bumper cover
- » **76-piece kit includes:** 32 lightweight machined aluminum inner & outer washers, 22 flat head socket screws & 22 locknuts

| | | |
|----------------------|---------|------|
| Spoiler Mounting Kit | 000-67K | \$33 |
|----------------------|---------|------|

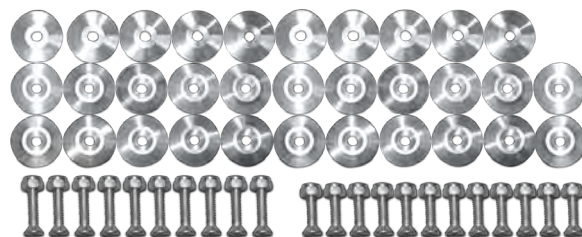

POLYCARBONATE RUB RAIL

- » Protect your vinyl without hiding it!
- » Attach to side of body to eliminate tire marks on fenders, doors, and quarter panels
- » Ultra-durable polycarbonate to absorb impact
- » Can be trimmed to fit your application

Rub Rail, 75" long

000-2100

\$19 ea



FULLY MOUNTED POLYCARBONATE RUB RAIL



PLASTIC VERSION INCLUDES CURVED EDGE FOR OPTIMUM AERODYNAMICS



000-5501P-W
MOLDED PLASTIC STANDARD ROCKER PANEL



ALUMINUM VERSION HAS ENDS ROLLED BY SPECIAL PROCESS, ENHANCING AIR FLOW



000-5501A-W
ALUMINUM STANDARD ROCKER PANEL



000-5500A-W
ALUMINUM STRAIGHT ROCKER PANEL

EDGES ARE LEFT STRAIGHT, NOT CURVED

MOLDED PLASTIC & ALUMINUM ROCKER PANELS

- » Mounts below the fender / door / quarter panel area and fits either side
- » Curved edges provide optimum aerodynamics and adds structural integrity to side body panels
- » Manufactured in high-impact plastic and lightweight aluminum
- » Available in 5 color options

| | | | -W -B | -CB -R |
|-------------------------------------|-------------|--------------|-------|--------|
| High-Impact Plastic (N/A IN YELLOW) | 000-5501P-x | 82"x 5" | \$33 | \$38 |
| Aluminum | 000-5501A-x | 77-3/4" x 5" | \$39 | \$39 |
| Aluminum, straight | 000-5500A-x | 79" x 4-3/4" | \$39 | n/a |

FITS THESE BODY STYLES: ABC NEXTGEN, ABC, NEXTGEN LMSC, LMSC, NORTH AMERICAN SPORTSMAN, S2 SPORTSMAN, SHORT TRACK TRUCK, STREET STOCK

ALUMINUM WINDOW BRACES

- » Strongest window braces on the market
- » Designed to the exact contour of your Five Star windows
- » Made of premium high-strength aluminum with flat black powder-coated finish
- » Foam-padded surface won't scratch your windows
- » Pre-drilled holes to mount adjustable bracing from the interior dash
- » **Kit includes:** 3 aluminum braces & installation hardware

| Windshield Brace Kits | | C=Center, L=Left, R=Right, O=outer, all 1" Wide | |
|--|-------------|---|------|
| ABC Next Gen Windshield Brace Kit | 11002-76333 | 24-1/8"(C), 24-1/4"(L), 24-1/2"(R) | \$84 |
| NextGen Late Model Stock Car Windshield Brace Kit | 13002-76333 | 25-5/8"(C), 25-1/2"(L), 25-5/8"(R) | \$84 |
| ABC/LMSC/Straight-Up Metal Windshield Brace Kit | 564-6301 | 28-5/8" x 1" | \$84 |
| North American Sportsman Windshield Brace Kit | 12001-76333 | 26" x 1" | \$84 |
| Pavement Modified Windshield Brace Kit | 020-6301 | 26-1/2" x 1" | \$84 |
| Short Track Truck Windshield Brace Kit | 21001-76333 | 31-5/8"(C), 31-3/4"(L), 31-1/2"(R) | \$84 |
| Rear Window Brace Kits | | C=Center, L=Left, R=Right, O=outer, all 1" Wide | |
| ABC NextGen Rear Window Brace Kit | 11002-76133 | 30-7/8"(C), 30-5/8"(O) | \$84 |
| NextGen Late Model Stock Car Rear Window Brace Kit | 11002-76133 | 30-7/8"(C), 30-5/8" (O) | \$84 |
| ABC/LMSC/Straight-Up Metal Rear Window Brace Kit | 674-6101 | 32" x 1" | \$84 |
| North American Sportsman Rear Window Brace Kit | 12001-76133 | 31-1/4"(C), 30-1/2"(O) | \$84 |
| Pavement Modified Rear Window Brace Kit | 020-6101 | 34" x 1" | \$84 |

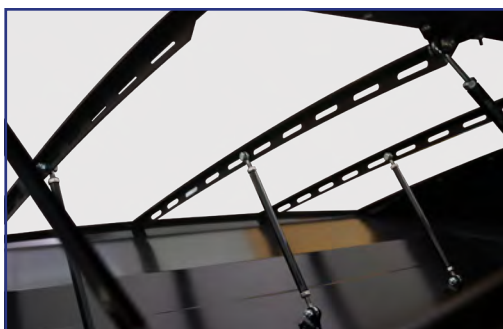

FULLY INSTALLED WINDOW BRACE KIT

WEIGHS LESS THAN 2 LBS



IMPORTANT:
USING RIVETS APPLIES TOO MUCH PRESSURE TO YOUR WINDOW & WILL FRACTURE THE POLYCARBONATE

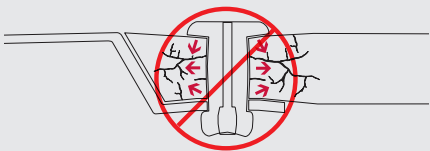

WINDOW INSTALLATION KIT

- » Using proper hardware provides the perfect fit & helps to increase the life of your window
- » Black oxide coated to prevent rust
- » Enough hardware to install a complete set of windows on one car
- » **Kit includes:** 120 6-32 1/2" & 16 6-32 3/4" flat head socket screws, 136 6-32 nylon locknuts, 1 long-arm hex key & 9/64" drill bit

| | | |
|-------------------------|-----|------|
| Window Installation Kit | 805 | \$27 |
|-------------------------|-----|------|

WINDOW INSTALLATION COUNTERSINK DRILL BIT

- » 3/8" diameter steel bit, 1/4" shank
- » Use this drill bit to countersink holes perfectly for window screw installation into polycarbonate!
- » Ensures a flush fit and a secure hold every time
- » Not required for pre-cut to fit, beveled, & drilled windows

| | | |
|-----------|-------|------|
| Drill Bit | 805-1 | \$19 |
|-----------|-------|------|

RIGHT SIDE DOOR SUPPORT

- » Easily adjust your right side door to the proper width
- » This piece connects your right side door bar to your door
- » .080" thick aluminum laser-cut to reduce weight
- » Laser cutting allows for precise, consistent shape & weight
- » Slotted mounting holes allow for easy inner & outer door adjustments to proper width
- » Weighs under 2 lbs

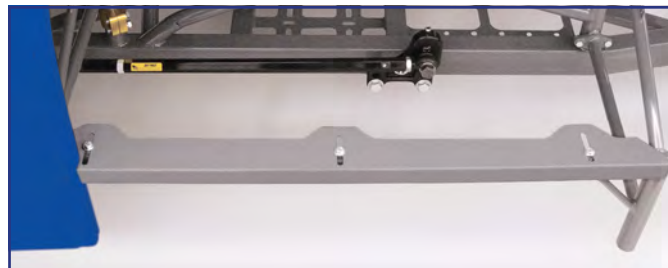

FULLY INSTALLED 11002-75533

| | | |
|-----------------------|-------------|------|
| Aluminum Door Support | 11002-75533 | \$30 |
|-----------------------|-------------|------|

FITS THESE BODY STYLES: ABC NEXTGEN, ABC, S2 SPORTSMAN, NORTH AMERICAN SPORTSMAN, SHORT TRACK TRUCK, DIRT GRAND NATIONAL



DRILL BIT KIT

- » Special double-ended drill bits
- » These bits drill a slightly larger diameter hole than a standard 1/8" or 3/16" bit to prevent stress cracks in the material
- » The short drill shaft makes drilling in tight places easier
- » Kit includes: 2 9/64" double-ended drill bits & 2 #30 double-ended drill bits

| | | |
|---------------|-----|------|
| Drill Bit Kit | 806 | \$18 |
|---------------|-----|------|

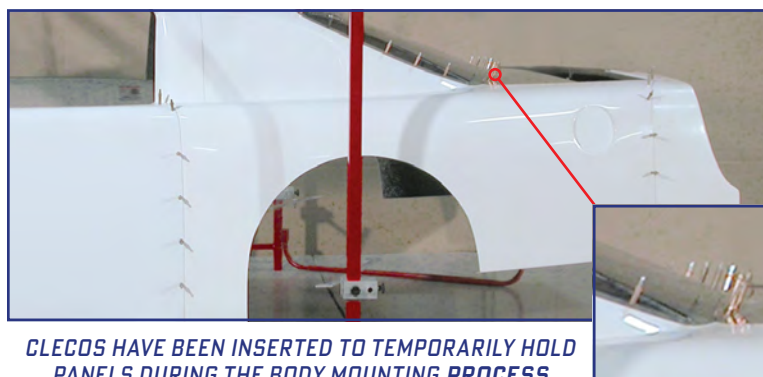

CLECOS HAVE BEEN INSERTED TO TEMPORARILY HOLD PANELS DURING THE BODY MOUNTING PROCESS

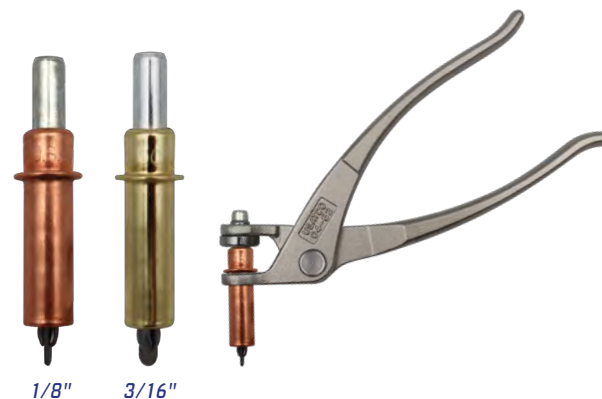

CLECO KIT & PLIERS

- » Precision has never been this easy! Cleco Pliers & Cleco Fasteners ensure perfect alignment every time
- » Clecos can be easily inserted with the Cleco Pliers to temporarily hold panels during the body mounting process
- » Our Cleco pliers are engineered for comfort & built to last, ensuring a secure grip & maximum control
- » Choice of 1/8" 25-piece Cleco Kit or 3/16" 25-piece Cleco Kit

| | | |
|------------------------------|-----|------|
| 1/8" Single Spade Kit, long | 812 | \$28 |
| 3/16" Single Spade Kit, long | 813 | \$36 |
| Cleco Pliers | 811 | \$12 |

PRICING SUBJECT TO CHANGE WITHOUT NOTICE

FENDER-TO-NOSE BACK-UP PLATES KIT

- » Reinforces the flange where the fenders mount to the nose
- » Pre-drilled holes in the necessary locations for quick & easy mounting
- » Made of .063" thick aluminum
- » **4-piece kit includes: 2 front & 2 rear plates (ENOUGH FOR BOTH SIDES)**

| | | |
|---|-------------|------|
| ABC NextGen / NextGen LMSC / NA Sportsman | 11002-75133 | \$20 |
| Other Body Styles* | 000-248 | \$21 |

*FITS THESE BODY STYLES: ABC, LMSC, S2, STRAIGHT-UP METAL, DIRT GRAND NATIONAL

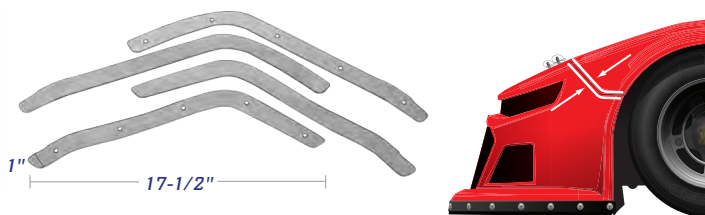

11002-75133

FOR ABC NEXTGEN, 2020 LATE MODEL STOCK CAR, NORTH AMERICAN SPORTSMAN



000-248

FOR ABC, LMSC, S2, STRAIGHT-UP METAL, DIRT GRAND NATIONAL

GREENHOUSE-TO-QUARTER PANEL BACK-UP PLATES KIT

- » Recommended for molded plastic quarter panels
- » Reinforce the flanges where the rear greenhouse meets the quarter panels
- » Universal fit for all greenhouse-style quarter panels
- » Each back-up plate is 60 X 1-12"
- » **Kit includes: 2 pre-cut aluminum strips**

| | | |
|-------------|---------|-----|
| 2-Piece Kit | 000-278 | \$7 |
|-------------|---------|-----|

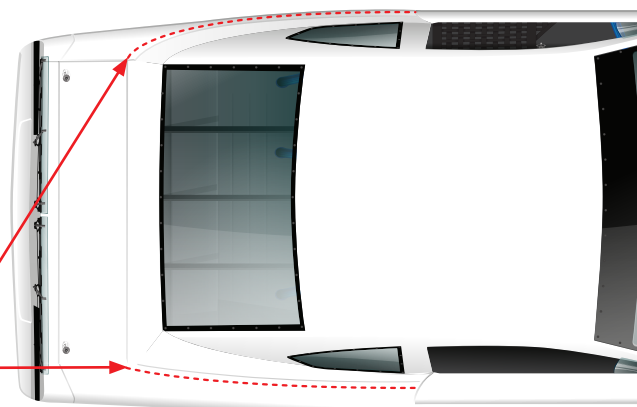

QUARTER PANEL BODY BRACE KIT

- » Stiffens the quarter panel to maintain correct shape in an aero sensitive area
- » Highly recommend bracing for tracks 1/2-mile & longer
- » Laser-cut aluminum braces have pre-drilled holes for brace attachment
- » **Kit includes: 2 braces that mount approximately 6" back from the wheel opening & 2" up from the bottom ledge**

| | | |
|--------------------|-------------|------|
| Brace Kit, 2-Piece | 11002-75433 | \$39 |
|--------------------|-------------|------|

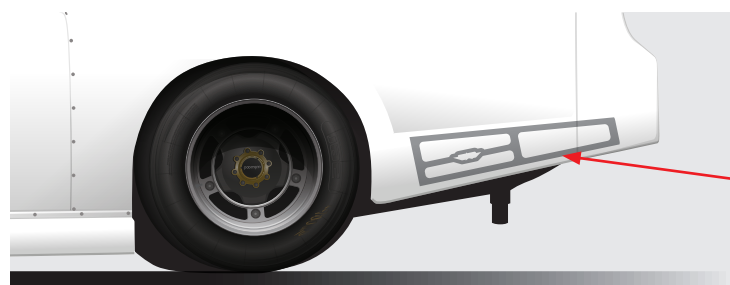

WEIGHS ONLY 1 LB

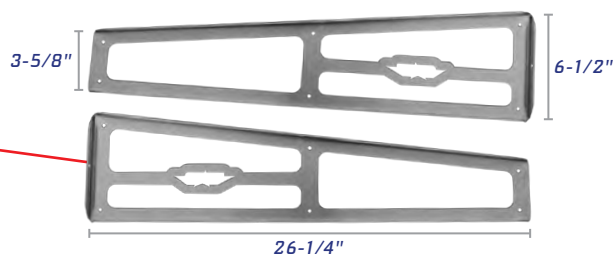

ADJUSTABLE BODY BRACES

- » Used for spoiler & roof supports & anywhere on your car to fit templates & meet other critical dimensions
- » Easy installation with ends shaped for included screw kit or 2 rivets
- » Adjustable from 8" to 10-1/2" & features durable anodized black finish & zinc-plated hardware
- » Add extra support without adding excess weight! Package of 2 weighs only 1/2 lb
- » Can also be attached to Five Star's Chassis Clamps for quick & easy adjustable bracing on your chassis

| | | |
|---------------------|-------|------|
| Body Braces, 2 pack | 807-3 | \$35 |
|---------------------|-------|------|



EASY INSTALLATION WITH ENDS DESIGNED FOR USE WITH THE INCLUDED SCREW KIT OR 2 RIVETS



STEEL TUBING INSTALLATION KIT

- » 55 feet of .035" hard-to-find, lightweight steel tubing for any miscellaneous needs on a race car
- » Will save at least 12 lbs over standard .065" steel tubing
- » Kit includes various shapes and sizes in 60" lengths

| | | |
|------------------------|-----|------|
| 11-pieces: 60" lengths | 819 | \$79 |
|------------------------|-----|------|

| Number | Shape | Diameter | Thickness | Length |
|--------|------------|----------|-----------|--------|
| 1 | (3) round | 3/8" | .062" | 60" |
| 2 | (3) square | 1/2" | .035" | 60" |
| 3 | (2) round | 1/2" | .062" | 60" |
| 4 | (3) square | 3/4" | .049" | 60" |

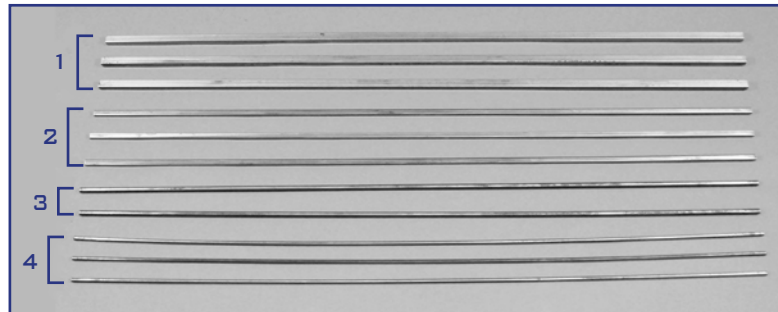

FORMED POLYCARBONATE BODY BRACES

- » Universal brace to fit any applicable area of your car
- » Each lightweight brace weighs only 7 oz
- » Absorbs impact & allows body panels to flex upon impact & return to original position & shape
- » Kit includes: 7 clear polycarbonate braces & 14 1"x2" aluminum mounting tabs

| | | |
|----------------------|-----|------|
| Polycarbonate Braces | 804 | \$33 |
|----------------------|-----|------|

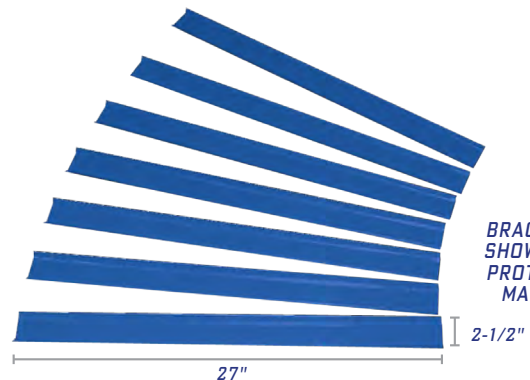

BRACES ARE SHOWN WITH PROTECTIVE MASKING

ALUMINUM CUSTOM BRACING KIT

- » Build your own custom-length bracing as short as 6" or as long as 40"
- » Order as many tubing kits or end assemblies as needed to custom brace your car
- » Threaded end assemblies can be bolted, riveted, or attached with hose clamps
- » Complete kit includes: 1 aluminum tubing kit; 1 threaded end assembly kit; 1 left & 1 right 1/4-20 reusable tap
- » Aluminum Tubing kit includes: 2 7/16" x 3' hollow hex rods. Cut to desired length & can be tapped easily
- » Threaded End Assemblies kit includes: 2 right and 2 left threaded ends, 2 hose clamps that weighs 7.5 oz

| | | |
|--------------------------|---------|------|
| Complete Kit | 807 | \$68 |
| REPLACEMENT PARTS | | |
| Tubing Kit, 2-Piece | 807-1 | \$29 |
| End Assemblies, 6-Piece | 807-2 | \$19 |
| Tap, left or right | 807LorR | \$10 |

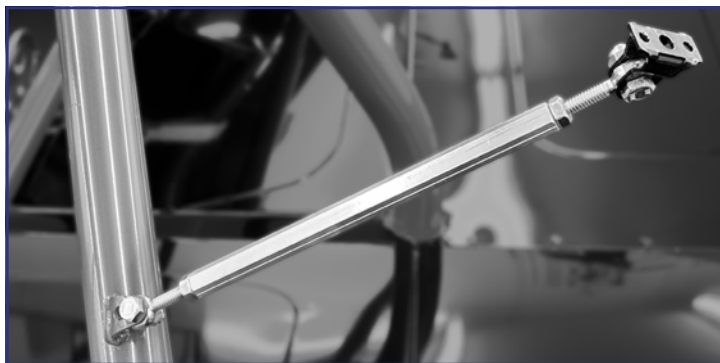

FULLY INSTALLED CUSTOM BRACE KIT



ALUMINUM TUBING | 807-1



TAP | 807L OR 807R



THREADED END ASSEMBLIES | 807-2

STEEL BODY MOUNTING TABS

- » Designed to be welded onto chassis as a universal mount for many applications
- » Makes mounting easier by positioning bracing and mounts right where you need them
- » 25-piece kit includes enough lightweight weld-on tabs to install a complete body & weighs 5 oz
- » Each tab is 1-1/8" x 1-2"
- » Use for roof, cowl, deck lid, side bracing, and more

| | | |
|--------------|-------|------|
| 25-Piece Kit | 807-4 | \$24 |
|--------------|-------|------|



CLOSE UP OF FULLY INSTALLED TAB



PREMIUM ADJUSTABLE BODY BRACES & ALUMINUM CHASSIS CLAMPS

CLOSE-UP OF STAMPED
ALUMINUM END



TWO BRACES CAN ALSO BE
MOUNTED TO A FIVE STAR
CHASSIS CLAMP

THUMB SCREW FOR QUICK, EASY ADJUSTMENT
TO MEET CRITICAL DIMENSIONS

TWO BRACES CAN ALSO BE
MOUNTED TO A FIVE STAR
CHASSIS CLAMP

INCLUDES 2 SCREWS FOR
A QUICK, EASY INSTALL & ADJUSTMENT
WITH 3MM ALLEN WRENCH

NYLON: MOST FLEXIBLE - 5 oz ea.

ALUMINUM: LIGHTEST - 3.25 oz ea.

STEEL: MOST DURABLE - 8.25 oz ea.

PREMIUM ADJUSTABLE BODY BRACE KITS

- » Available in three options: aluminum, nylon, or steel
- » Adjustable to a maximum length of 30-1/2"
- » Stamped, black anodized aluminum mounting ends
- » Thumb screw for quick, easy length adjustments without tools
- » Kits come complete in a pack of 2

| | | |
|--------------------------|-------------|------|
| Flexible Nylon Brace Kit | 10001-75951 | \$33 |
| Aluminum Brace Kit | 10001-75933 | \$33 |
| Steel Brace Kit | 10001-75931 | \$25 |

ALUMINUM CHASSIS CLAMPS

- » Universal mount fits anywhere bracing is needed
- » Eliminate the need for welding or use of hose clamps when mounting body braces
- » Threaded flange / no nut required
- » Three options to fit different roll bar tubing thickness
- » Lightweight black anodized aluminum, each clamp weighs just 1.3 oz
- » Ideal for use with Five Star's Premium Adjustable Body Braces
- » **Kits include:** 2 clamps with 1/4-20 screws

| | | |
|--------------------------|-------------|------|
| 1-1/2", aluminum, 2 pack | 10001-74133 | \$21 |
| 1-3/4", aluminum, 2 pack | 10001-74333 | \$21 |
| 1-5/8", aluminum, 2 pack | 10001-74533 | \$21 |



PRICING SUBJECT TO CHANGE WITHOUT NOTICE

POLYCARBONATE DOOR VENT WINDOWS

- » Molded vent windows give cars a proven performance gain in the wind tunnel over flat unmolded windows
- » Oversized and cut-to-fit options made of molded, mar-resistant coated clear .093" polycarbonate

| | | |
|--|-------------|------|
| Precut-to-fit, set of 2 | 11002-66222 | \$38 |
| <i>FITS THESE BODY STYLES: ABC NEXTGEN, NEXTGEN LMSC</i> | | |
| Universal, set of 2 | 000-6202 | \$39 |

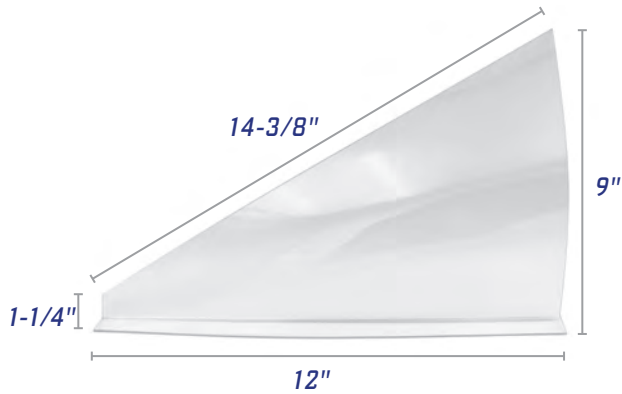

THE 11002-66222 DOOR VENT WINDOW IS CUT-TO-FIT FOR FAST & EASY INSTALLATION



THE 000-6202 DOOR VENT WINDOW IS OVERSIZED; TRIM TO FIT YOUR APPLICATION

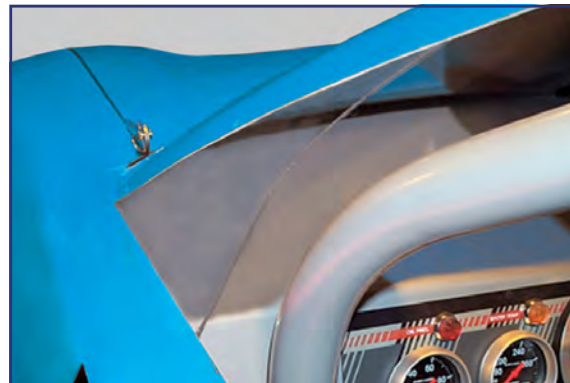

WIDE ANGLE RACING MIRROR

- » This convex glass mirror gives you the best view of your competition, includes a bracket kit for easy installation
- » All black frame with black anodized machined aluminum brackets
- » Only weighs 19 oz

| | | |
|---------------------|-------------|------|
| Convex Glass Mirror | 00001-85020 | \$49 |
|---------------------|-------------|------|



UNIVERSAL MIRROR MOUNTING BRACKET

- » This stamped lightweight aluminum bracket allows for easy installation on any chassis
- » Satin black powder coated finish

| | | |
|---------------------|-------|-----|
| Replacement Bracket | 820-B | \$9 |
|---------------------|-------|-----|



THE PERFECT SURFACE PREP FOR PLASTIC

MD3 ADHESION PROMOTER

FAST DRYING & NON-SANDING



MD3 ADHESION PROMOTER

- » Specifically engineered adhesion promoter assures proper paint bonding to our special plastic
- » Other automotive grade primers on the market may not work at all or cause severe paint flaking
- » Improves adhesion of vinyl by enhancing the bond between adhesive on the vinyl and the substrate, for a more durable, long-lasting application
- » Comes in an aerosol spray can for quick and easy application
- » A single can coats approximately 5 individual parts

| | | |
|-----------------------|-----|------|
| MD3 Adhesion Promoter | 842 | \$16 |
|-----------------------|-----|------|

» A MUST USE PRODUCT BEFORE PAINTING OR APPLYING VINYL ON ANY FIVE STAR PLASTIC PART

FIVE STAR PLASTIC WINDOW CLEANER

- » This specially formulated anti-static foaming spray contains no chemicals or abrasives that will cause damage to plastic
- » Lifts grease, grime, and wipes off fast and easy to provide a streak-free clean and clear surface finish

| | | |
|--------------------------|-----|--------|
| Window Cleaner, 19oz Can | 843 | \$9.95 |
|--------------------------|-----|--------|

» FIVE STAR CLEANING TIPS!

- » ALWAYS AVOID USING ABRASIVE CLEANERS & CHEMICAL SOLVENTS THAT CAN EASILY CAUSE DAMAGE TO POLYCARBONATE WINDOWS
- » USE A MICROFIBER TOWEL FOR BEST, STREAK-FREE FINISH
- » TO PREVENT SCRATCHING AND HAZING ON YOUR WINDOWS, NEVER SCRUB WITH BRUSHES OR ABRASIVE MATERIALS



PRICING SUBJECT TO CHANGE WITHOUT NOTICE

UNIVERSAL SHORT TRACK

NOSES, BUMPER COVERS & COMPONENTS

VINYL NOSE GRAPHIC ID KITS FOR A REALISTIC OEM LOOK!

PRINTED ON OUTDOOR DURABLE HIGH-TACK VINYL • GLOSS LAMINATED SURFACE PROVIDES EXCELLENT PROTECTION



CHEVROLET CAMARO

-W -B -CB -R

| | | | |
|-------------|---------------|-------|-------|
| Nose | 11132-41051-x | \$164 | \$171 |
| Nose ID Kit | 11132-44141 | \$39 | \$39 |

CHEVROLET CAMARO

-W -B -CB -R

| | | | |
|---------------------|---------------|-------|-------|
| Bumper Cover | 11002-45051-x | \$155 | \$160 |
| Bumper Cover ID Kit | 11132-44542 | \$38 | \$38 |



'97 CHEVROLET CAMARO

-W

| | | |
|------|-----------|-------|
| Nose | 150-410-W | \$178 |
|------|-----------|-------|

*NOSE GRAPHIC ID KITS NO LONGER AVAILABLE

'97 CHEVROLET CAMARO

-W

| | | |
|--------------|-----------|-------|
| Bumper Cover | 150-450-W | \$160 |
|--------------|-----------|-------|

*BUMPER COVER GRAPHIC ID KITS NO LONGER AVAILABLE



'92 CHEVROLET CAMARO

-W -B

| | | |
|-----------------|------------|-------|
| Nose (PAVEMENT) | 140-410-x | \$178 |
| Nose ID Kit | 140-410-ID | \$39 |

'92 CHEVROLET CAMARO

-W -B

| | | |
|-------------|------------|-------|
| Nose | 145-410-x | \$178 |
| Nose ID Kit | 140-410-ID | \$39 |



'81 CHEVROLET CAMARO

-B

Nose, Upper 210-410U-B \$80

*NOSE GRAPHIC ID KITS NO LONGER AVAILABLE

'81 CHEVROLET CAMARO

-B

Nose, Lower 210-410L-B \$75

*NOSE GRAPHIC ID KITS NO LONGER AVAILABLE



'03 CHEVROLET MONTE CARLO

-W -B

| | | |
|-----------------------------|------------|-------|
| Nose (FIBERGLASS SPORTSMAN) | 639-410-x | \$178 |
| Nose (SHORT TRACK) | 640-410-x | \$178 |
| Nose ID Kit | 630-410-ID | \$39 |

'03 CHEVROLET MONTE CARLO

-W -B

| | | |
|---------------------|------------|-------|
| Bumper Cover | 630-450-x | \$160 |
| Bumper Cover ID Kit | 630-450-ID | \$38 |



'94 CHEVROLET LUMINA

-W

Nose 610-410-W \$178

*NOSE GRAPHIC ID KITS NO LONGER AVAILABLE

'94 CHEVROLET LUMINA

-W

Bumper Cover 610-450-W \$160

*BUMPER COVER GRAPHIC ID KITS NO LONGER AVAILABLE



'03 FORD TAURUS

-W -B

| | | |
|------|-----------|-------|
| Nose | 550-410-x | \$178 |
|------|-----------|-------|

**NOSE GRAPHIC ID KITS NO LONGER AVAILABLE*

'03 FORD TAURUS

-W -B

| | | |
|--------------|-----------|-------|
| Bumper Cover | 550-450-x | \$160 |
|--------------|-----------|-------|

**BUMPER COVER GRAPHIC ID KITS NO LONGER AVAILABLE*



'97 FORD THUNDERBIRD

-W

| | | |
|------|-----------|-------|
| Nose | 530-410-W | \$178 |
|------|-----------|-------|

**NOSE GRAPHIC ID KITS NO LONGER AVAILABLE*

'97 FORD THUNDERBIRD

-W

| | | |
|--------------|-----------|-------|
| Bumper Cover | 530-450-W | \$160 |
|--------------|-----------|-------|

**BUMPER COVER GRAPHIC ID KITS NO LONGER AVAILABLE*



PONTIAC GRAND PRIX

-W -B

| | | |
|-------------|------------|-------|
| Nose | 360-410-x | \$164 |
| Nose ID Kit | 360-410-ID | \$39 |

PONTIAC GRAND PRIX

-W -B -CB -R

| | | | |
|--------------|-----------|-------|-------|
| Bumper Cover | 460-450-x | \$155 | \$160 |
|--------------|-----------|-------|-------|

**BUMPER COVER GRAPHIC ID KITS NO LONGER AVAILABLE*



'97 OLDSMOBILE CUTLASS

-W

| | | |
|------|-----------|-------|
| Nose | 710-410-x | \$178 |
|------|-----------|-------|

**NOSE GRAPHIC ID KITS NO LONGER AVAILABLE*



UNIVERSAL HEADLIGHT DECALS



H00-410S: Round, small - \$8



H01-410S: Rectangle, small - \$8



H00-411S: Round, large - \$12



H01-411S: Rectangle, large - \$12

ACHIEVE MAXIMUM VINYL ADHESION BY USING MD3 ADHESION PROMOTER. DETAILS AND ORDERING INFORMATION ON PAGE 167!



» ALUMINUM NOSE SCREENS: PROTECT YOUR RADIATOR FROM DEBRIS PENETRATION

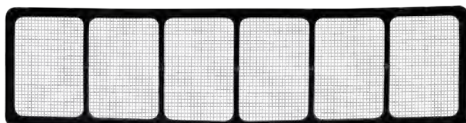

BLACK ALUMINUM FRAME

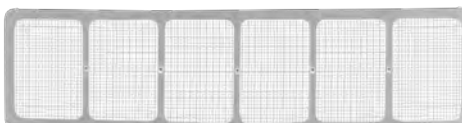

UNPAINTED

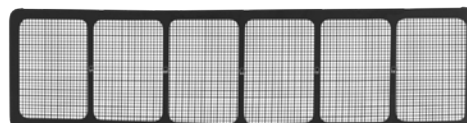

BLACK POWDER-COATED

ALUMINUM NOSE SCREENS

- » Protects the radiator from debris penetration
- » Frame is laser cut from lightweight aluminum
- » Screen is high strength stainless steel (3/16" mesh is crimped, 1/4" is welded)
- » Available options: black aluminum frame, unpainted, or with durable satin black powder-coated finish

| PN | NOSE SCREEN DESCRIPTION | WIDTH (Top) | WIDTH (Bottom) | HEIGHT | MESH | |
|--------------|-------------------------------------|-------------|----------------|--------|-------|------|
| 630-4111 | 03 Monte Carlo, Lower | 34" | 34" | 6" | 3/16" | \$50 |
| 660-4111 | Common*, Lower | 27-3/4" | 27-3/4" | 7-1/4" | 3/16" | \$50 |
| 660-4111-B | Common, Lower, Black | 27-3/4" | 27-3/4" | 7-1/4" | 3/16" | \$55 |
| 660-4112 | Common, Lower | 27-3/4" | 27-3/4" | 7-1/4" | 1/4" | \$50 |
| 660-4112-B | Common, Lower, Black | 27-3/4" | 27-3/4" | 7-1/4" | 1/4" | \$55 |
| 10001-46333B | Common, Lower, Black aluminum frame | 27-3/4" | 27-3/4" | 7-1/4" | 3/16" | \$55 |
| 10001-46433B | Common, Lower, Black aluminum frame | 27-3/4" | 27-3/4" | 7-1/4" | 1/4" | \$55 |

*COMMON NOSE SCREEN FITS THESE BODY STYLES: ABC NEXTGEN, ABC, NEXTGEN LATE MODEL STOCK CAR, LATE MODEL STOCK CAR, NORTH AMERICAN SPORTSMAN, STRAIGHT-UP METAL, MD3 CAMARO/MUSTANG STREET STOCK, DIRT GRAND NATIONAL

PRICING SUBJECT TO CHANGE WITHOUT NOTICE

REPRESENT AT THE TRACK WITH

FIVE STAR

MERCHANDISE



»» PERFORMANCE HOODIE

100% POLYESTER | UNISEX SIZES: S-4XL - \$40.00



»» FIVE STAR BRAND TEE

50/50 COTTON BLEND | UNISEX SIZES: S-4XL - \$20.00



» LADIES FASHION TANK

60/40 COTTON POLY BLEND | SIZES: XS-4XL - \$20.00

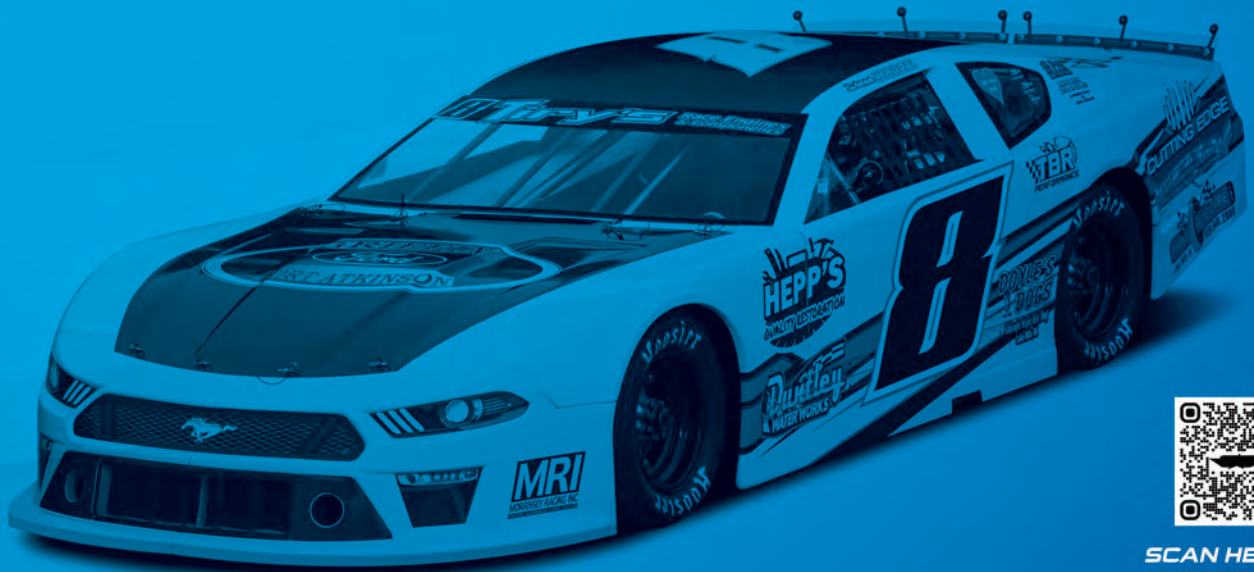

SCAN HERE TO SHOP ONLINE

#HEYNICEBODY

REPRESENT AT THE TRACK WITH

FIVE STAR MERCHANDISE



»FIVE STAR HATS

FLEX FIT HAT | S/M & L/XL: \$20.00

TRUCKER HAT | ONE SIZE FITS ALL: \$20.00



»FIVE STAR KNIT BEANIES

100% ACRYLIC RIB KNIT | ONE SIZE UNISEX: GRAY OR BLACK: \$20.00



» FUN FIVE STAR EXTRAS!

CAN KOOZIE OR PREMIUM VINYL STICKER SETS: \$4.00 each



SCAN HERE TO SHOP ONLINE

#HEYNICEBODY