

ENGINEERED THROUGH THE DRIVER'S EYES



# DIRT LATE MODEL

**THE #1 CHOICE FOR DIRT RACERS**

All panels are designed with great style, provide maximum downforce,  
& are proven to be the most durable, cost-effective  
products on the market.





- » Molded plastic panels provide unmatched flexibility and durability
- » Advanced lightweight composite panels are very close to a carbon fiber blend in strength & weight
- » Premium plastic materials available exclusively in MD3 products
- » Achieve maximum vinyl adhesion by using MD3 Adhesion Promoter
- » See color options for all body panels & components in ordering section

<b>W</b> WHITE	<b>G</b> GRAY	<b>B</b> BLACK	<b>CB</b> BLUE	<b>R</b> RED	<b>O</b> ORANGE	<b>Y</b> YELLOW	<b>FG</b> FLUOR. GRN	<b>FO</b> FLUOR. ORG	<b>FR</b> FLUOR. RED	<b>FY</b> FLUOR. YEL
-------------------	------------------	-------------------	-------------------	-----------------	--------------------	--------------------	-------------------------	-------------------------	-------------------------	-------------------------

CONNECT WITH TEAM FIVE STAR | [FIVESTARBODIES.COM](http://FIVESTARBODIES.COM)    

# DIRT LATE MODEL

## EVOLUTION 2 NOSE COMBO KIT

### EVOLUTION 2 NOSE COMBO KIT

		-W	-B	-CB	-G	-OR	-R	-Y	-FG	-FO	-FR	-FY	
Nose, 2-piece, high-impact plastic	32004-41051-x											N/A	
Nose Lower Aero Valance, high-impact plastic	32004-41751-x											\$87	
Fender, upper, left, high-impact plastic	32004-23251-xL											N/A	
Fender, upper, right, high-impact plastic	32004-23251-xR											N/A	
Fender, lower, left, high-impact plastic	32004-23351-xL											\$56	
Fender, lower, right, high-impact plastic	32004-23351-xR											\$56	
<b>NOSE COMBO KIT PRICE</b>	<b>32004-43554-x</b>											<b>\$507</b>	<b>\$560</b>

TO ADD A REALISTIC OEM LOOK TO YOUR NOSE, SEE VINYL NOSE GRAPHIC ID KITS | PAGE 79



### 2-PIECE UPPER & LOWER FENDERS ALLOWS FOR EXACT GROUND HEIGHT ADJUSTMENT



Right Fender has more clearance for tire travel to allow for lower mounting height.

Left Fender is raised for maximum downforce



Lower Fenders are separate for improved fit, have a tapered valance built-in, and are thicker for improved durability. Also adjustable to meet desired ground clearance.

Lower Aero Valance (below the nose) is tapered and is thicker for improved durability.



Separate lower right front fender for quick & easy replacement.

### COMPLETE COMMON BODY PACKAGE NOSE COMBO KIT PLUS ITEMS BELOW

		-W	-B	-CB	-G	-OR	-R	-Y	-FG	-FO	-FR	-FY	
Door, high-impact plastic, right (N/A IN GRAY)	32001-21051-xR											N/A	
Hood, composite (N/A IN GRAY)	32003-33512-x											N/A	
Nose Filler Panel, high-impact plastic	32000-35851-x											N/A	
Quarter Panel, high-impact plastic, right (N/A IN GRAY)	32001-27351-xR											N/A	
Roof, composite (N/A IN GRAY)	006-5101L-x											N/A	
Roof Cap, plastic (N/A IN GRAY) (CARBON FIBER -CF AVAILABLE FOR \$38)	006-500-x											\$35	
Rocker Panel, fits either side, high-impact plastic (3 REQUIRED)	007-5500-x											\$46	
Rocker Panel, fits either side, high-impact plastic (ENTERED AGAIN TO SHOW PACKAGE PRICE)	007-5500-x											\$46	
Rocker Panel, fits either side, high-impact plastic (ENTERED AGAIN TO SHOW PACKAGE PRICE)	007-5500-x											\$46	
<b>COMPLETE BODY PACKAGE PRICE</b>	<b>32004-10352-x</b>											<b>\$2,046</b>	<b>\$2,117</b>

# DIRT LATE MODEL

## EVOLUTION NOSE COMBO KIT

### EVOLUTION NOSE COMBO KIT

		-W	-B	-CB	-G	-OR	-R	-Y	-FG	-FO	-FR	-FY
Nose, 2-piece, high-impact plastic	32003-41051-X											N/A
Fender, left, high-impact plastic	32003-23051-XL											N/A
Fender, right, high-impact plastic	32003-24051-XR (FLAT)	32003-23051-XR (RAISED)										N/A
<b>NOSE COMBO KIT PRICE</b>		<b>32003-43554-x</b>										<b>\$371</b>

TO ADD A REALISTIC OEM LOOK TO YOUR NOSE, SEE VINYL NOSE GRAPHIC ID KITS | PAGE 79



### COMPLETE COMMON BODY PACKAGE NOSE COMBO KIT PLUS ITEMS BELOW

		-W	-B	-CB	-G	-OR	-R	-Y	-FG	-FO	-FR	-FY
Door, high-impact plastic, right (N/A IN GRAY OR YELLOW)	32001-21051-xR											N/A
Hood, composite (N/A IN GRAY OR YELLOW)	32003-33512-x											N/A
Nose Filler Panel, high-impact plastic (N/A IN YELLOW)	32000-35851-x											N/A
Nose Aero Valance, lower, high-impact plastic (N/A IN YELLOW)	32003-41751-x											\$98
Quarter Panel, high-impact plastic, right (N/A IN GRAY OR YELLOW)	32001-27351-xR											N/A
Roof, composite (N/A IN GRAY)	006-5101L-x											N/A
Roof Cap, plastic (N/A IN GRAY) (CARBON FIBER -CF AVAILABLE FOR \$38)	006-500-x											\$35
Rocker Panel, fits either side, high-impact plastic (3 REQUIRED)	007-5500-x											\$46
Rocker Panel, fits either side, high-impact plastic (ENTERED AGAIN TO SHOW PACKAGE PRICE)	007-5500-x											\$46
Rocker Panel, fits either side, high-impact plastic (ENTERED AGAIN TO SHOW PACKAGE PRICE)	007-5500-x											\$46
<b>COMPLETE COMMON BODY PACKAGE PRICE</b>		<b>32003-10352-x</b>										<b>\$2,026</b>

\*\*PRICING SUBJECT TO CHANGE WITHOUT NOTICE\*\*

# DIRT LATE MODEL

## BODY PANELS & COMPONENTS

FIVE STAR BODY PANELS ARE DESIGNED TO MAINTAIN PRECISE FIT WITH OPTIMIZED AERODYNAMICS!



3" CURVED SCOOP

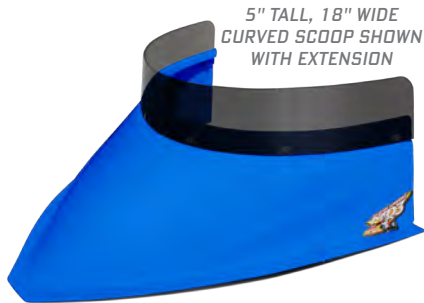

5" TALL, 18" WIDE  
CURVED SCOOP SHOWN  
WITH EXTENSION



OVERSIZED 80" X 30" PANEL IS TRIM-TO-FIT  
FOR YOUR CUSTOM APPLICATION

### HOOD SCOOPS

- » Lightweight, molded high-impact plastic scoops are shaped for peak aero performance
- » Three options to choose from: 3" tall x 16" wide, 5" tall x 16" wide and the all new 5" tall x 18" wide
- » Raise the height of your Hood Scoop using a polycarbonate Hood Scoop Extension to protect your air filter!
- » Available in 4 colors including a carbon fiber look; appearance of carbon fiber, at a fraction of the cost.

**-W -CB -R -CF**

Hood Scoop, 3" tall x 16" wide, curved	040-4114-X	\$52	\$59
Hood Scoop, 5" tall x 16" wide, curved	040-4116-X	\$52	\$59
Hood Scoop, 5" tall x 18" wide, curved	040-4118-X	\$52	\$61
Hood Scoop Extension, Tinted, 3"x16"	040-4117-TNT	\$38	N/A
Hood Scoop Extension, Tinted, 3"x18"	040-4119-TNT	\$41	N/A

### PLASTIC NOSE FILLER PANEL

- » Mounts between the nose, hood and fenders
- » Flat high-impact plastic sheet deflects debris and resists chipping, denting, bending
- » Outperforms traditional aluminum panels in every way!
- » Flame retardant material with high heat distortion temperature
- » Same weight per square foot as .040" aluminum!
- » Available in 5 colors **-W -B -CB -G -R**

Nose Filler Panel	32000-35851-X	\$128
-------------------	---------------	-------

# THE TOUGHEST SPOILER ON THE MARKET!

ABC LMSG TRUCK PAVMOD OUTLAW LATE MODEL SPORTSMAN OLDER BODIES MD3 LATE MODEL MD3 MODIFIED NORTHEAST MOD STOCK CAR STREET STOCK TAZ PRO STOCK/MOD FUNNY CAR JR RASTER WINDOWS ACCESSORIES

**NEW!**

## COMPLETE SPOILER KIT

- » Built out of 0.080 aluminum & high-impact plastic
- » Brackets built into left side blade for quick & easy adjustment
- » Kit includes: 8" tall x 56" wide left side blade with a 1" lip, 1 56-1/4" aluminum hinge, 3 spoiler side supports, 1 center support, and 1 molded high-impact plastic breakaway spoiler kit
- » Available in 5 colors

**-W -B -CB -G -R**

Complete Spoiler Kit	32000-72821-x	\$212
----------------------	---------------	-------

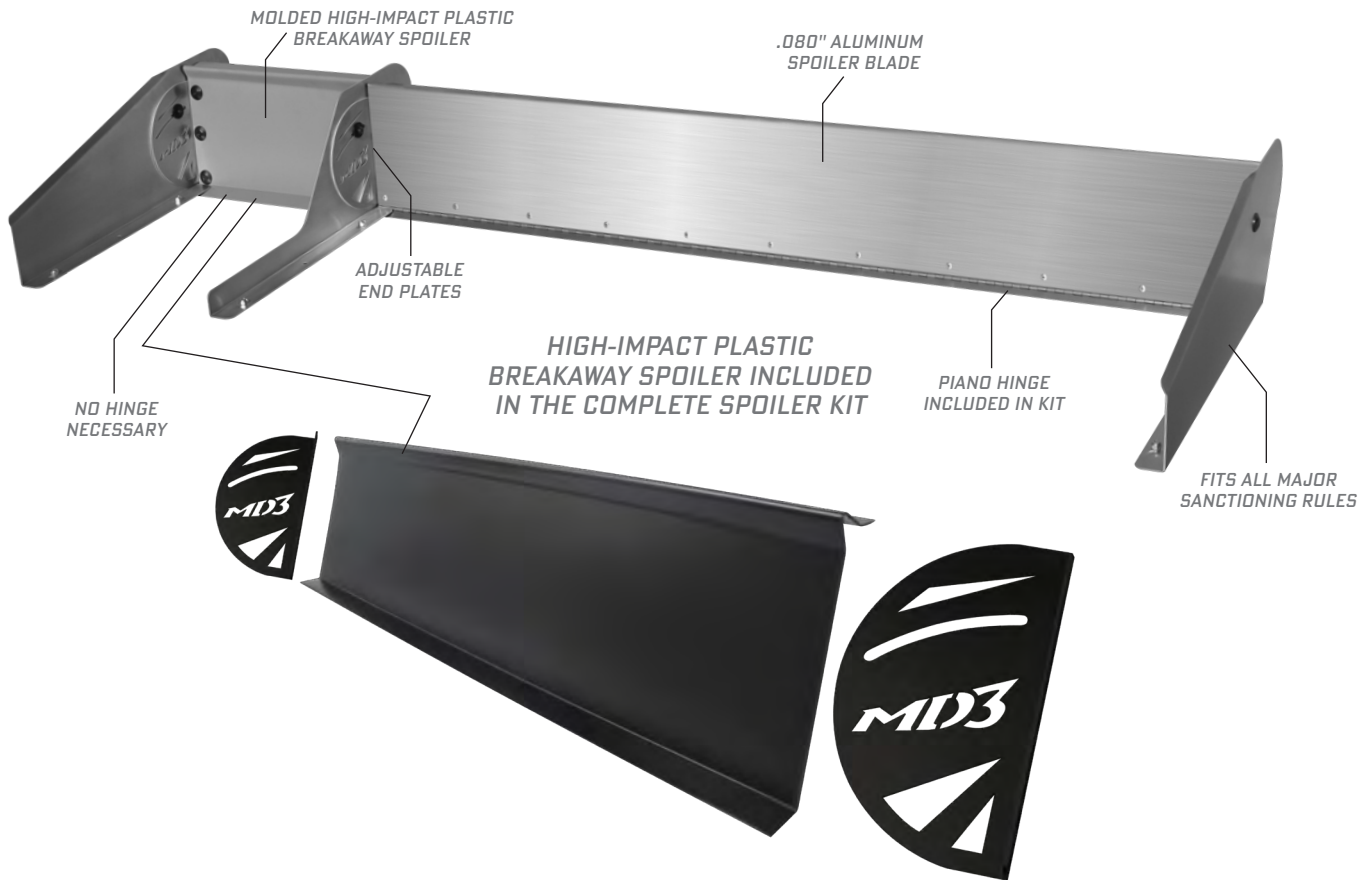

## MOLDED HIGH-IMPACT PLASTIC BREAKAWAY SPOILER KIT

- » **PLASTIC SPOILER BLADE:** Made of lightweight, molded high-impact plastic
- » 32" wide by 8 1/4" tall
- » **ALUMINUM ADJUSTABLE END PLATES:**
- » Made of premium high-strength aluminum with powder-coated finish
- » 4-1/2" wide by 7" tall
- » CNC machined slots make for easy spoiler angle adjustment
- » Kit includes: 1-Plastic Spoiler and 2-Aluminum Adjustable End Plates and is available in 5 colors

**-W -B -CB -G -R**

Molded High-Impact Plastic Breakaway Spoiler Kit	32000-72820-X	\$69
Plastic Right Side Spoiler Blade	32000-47751-X	\$29
Adjustable End Plates, pair	32000-47851-X	\$40
Adjustable End Plate, left	32001-47851L-X	\$20
Adjustable End Plate, right	32001-47851R-X	\$20



LEFT & RIGHT SIDE  
REPLACEMENT PLATES

\*\*PRICING SUBJECT TO CHANGE WITHOUT NOTICE\*\*

# DIRT LATE MODEL

## BODY PANELS & COMPONENTS

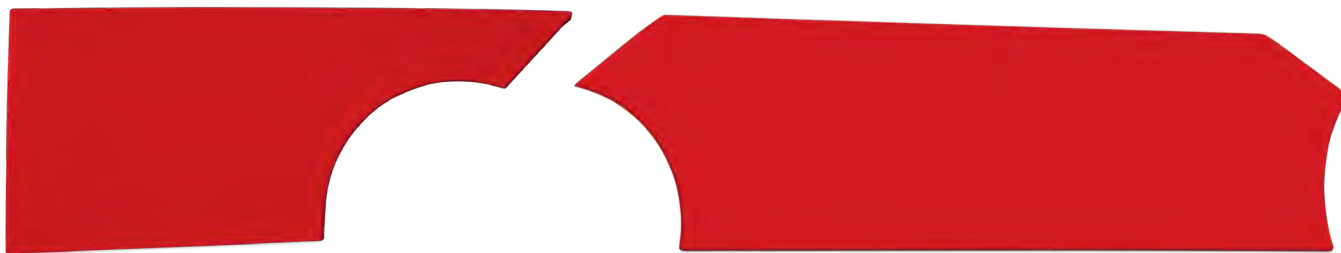

### PLASTIC QUARTER PANEL

Quarter Panel, right	32001-27351-xR	\$119
----------------------	----------------	-------

### PLASTIC RIGHT SIDE DOOR

Door, right	32001-21051-xR	\$152
-------------	----------------	-------

- » Molded high-impact plastic out performs aluminum in every way
- » Resists chipping, denting, & bending
- » Common design to fit most late model chassis
- » Meets all flame resistance test requirements
- » Molded flanges for added rigidity & easy installation
- » Approved for competition by all major national sanctioning series
- » Available in 5 colors **-W -B -G -CB -R**

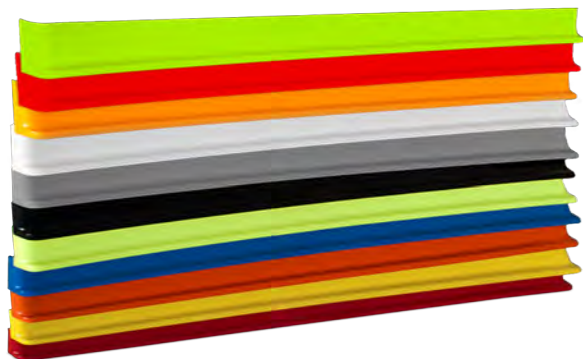

### PLASTIC ROCKER PANEL

- » These 77-3/4" x 7-1/4" lightweight, high-impact plastic rockers are aerodynamically designed for the best side force
- » They are easy to mount and add structural integrity to side body panels
- » Available in 11 colors

**-W -B -G -CB -R -Y -OR -FG -FO -FR -FY**

Rocker Panel	007-5500-x	\$40ea	\$46ea
--------------	------------	--------	--------



COCKPIT DEFLECTOR SHOWN WITH  
3" TINTED EXTENSION

### COCKPIT DEFLECTORS

- » High-impact molded plastic deflectors are ultra durable, withstand flying debris and divert air around the driver
- » Available in 6 colors **-W -B -G -CB -R -Y**
- » Raise the height of your cockpit deflector using a polycarbonate Cockpit Extension to allow for more visibility
- » Cockpit Extension available in 3" and 4" height, clear & tinted

Cockpit Deflector, plastic	040-4106-X	\$74
Cockpit Extension, Clear, 3"	040-4107-CLR	\$49
Cockpit Extension, Tinted, 3"	040-4107-TNT	\$49
Cockpit Extension, Clear, 4"	040-4108-CLR	\$58
Cockpit Extension, Tinted, 4"	040-4108-TNT	\$58

SHAPED FOR PEAK AERO PERFORMANCE WITH TREMENDOUS SHEAR (TEAR) RESISTANCE



### LIGHTWEIGHT COMPOSITE HOOD

- » Holds shape at all speeds with minimal or no bracing!
- » Made from advanced lightweight composites
- » Weighs less than 8lbs!
- » Slightly oversized and can be trimmed to fit
- » Available in 5 colors

**-W -B -CB -R -Y**

Hood	32003-33512-x	\$486
------	---------------	-------

*\*YELLOW COMPOSITE BODY PANELS ARE SPECIAL ORDER PARTS, CONTACT FIVE STAR FOR AVAILABILITY AND LEAD TIME\*\**

ENHANCED DESIGN FOR IMPROVED AERODYNAMICS



### LIGHTWEIGHT COMPOSITE ROOF

- » Strong! Holds up to high speeds with minimal bracing
- » Advanced lightweight composite roof now made with Flame Retardant resin for added driver safety
- » 48" wide x 44" long, minimal bracing required
- » Weighs less than 7lbs!
- » Meets all sanctioning rules
- » Available in 4 colors

**-W -B -CB -R**

Roof	006-5101L-X	\$499
------	-------------	-------

*\*YELLOW COMPOSITE BODY PANELS ARE SPECIAL ORDER PARTS, CONTACT FIVE STAR FOR AVAILABILITY AND LEAD TIME\*\**

### PLASTIC ROOF CAPS

- » Made of high-impact molded plastic
- » 45-1/4" long and weighs only 8oz!
- » Available in 11 colors including a carbon fiber look (appearance of carbon fiber)

**-W -B -CB -R -Y -OR -FG -FO -FR -FY -CF**

Roof Cap	006-500-x	\$35	\$38
----------	-----------	------	------



CARBON FIBER LOOK CLOSE-UP (-CF)



# DIRT LATE MODEL

## BODY PANELS & COMPONENTS

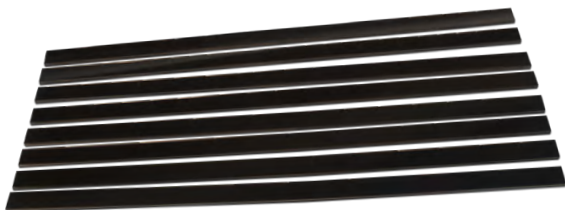

1-1/4" WIDE X 36" LONG X (FLAT) 0.30" THICK



### STANDARD PLASTIC BODY BRACES

- » Constructed of the same specially-blended, high-impact plastic as our MD3 noses
- » Each lightweight brace weighs only 7 oz
- » Perfect for taking abuse on the dirt
- » 1-1/4" wide x 36" long x (flat) 0.30" thick
- » Trims easily to fit your needs

**-B**

Single Body Brace	040-8000	\$11 ea
Pkg of (8) Body Braces	040-8000-8	\$58



### PLASTIC LOWER NOSE SUPPORT

- » This lightweight, durable plastic 37" long nose support is made out of .350" thick polyethylene
- » Fits either side of your nose
- » Two are required for a complete install
- » Available in black only

Nose Support	32003-410-1	\$42 EA
--------------	-------------	---------



### OIL COOLER SCOOP

- » High-impact molded plastic scoop has a sleek aerodynamic design that directs air for cooling
- » Can be mounted forward or backward!
- » Available in white and a carbon fiber look; appearance of carbon fiber, at a fraction of the cost

**-W-CF**

Oil Cooler Scoop	040-4105-X	\$29
------------------	------------	------

SCAN HERE TO



SHOP ONLINE

» FOR OLDER DIRT LATE MODEL BODY PANELS, VISIT OUR WEBSITE!



# ALL NEW MD3 AIR FILTER SHIELD



## AIR FILTER SHIELD

- » The perfect solution for unexpected weather at the track
- » Durable & lightweight molded plastic
- » Quick & easy install & removal

Air Filter Shield	30001-35451-B	\$39
-------------------	---------------	------



3" AIR FILTER DEFLECTOR



5" AIR FILTER DEFLECTOR



6" AIR FILTER DEFLECTOR

## AIR FILTER DEFLECTORS

- » Lightweight, high-impact molded plastic deflectors have a sleek aerodynamic design that provides maximum air filter protection
- » Three options to choose from: 3", 5", and 6" height
- » Available in 4 colors including a carbon fiber look; appearance of carbon fiber, at a fraction of the cost.

		-W-CB-R	-CF
Air Deflector, 3" tall x 16" wide	040-4100-X	\$40	\$47
Air Deflector, 5" tall x 15" wide	040-4101-X	\$40	\$47
Air Deflector, 6" tall x 18" wide	040-4102-X	\$48	\$55

**NEW!**

\*\*PRICING SUBJECT TO CHANGE WITHOUT NOTICE\*\*



# PREMIUM UNIVERSAL PLASTIC FLAT SHEETS



- » Replace traditional aluminum with this extremely durable plastic
- » Resists chipping, denting, bending to last much longer than aluminum panels
- » Flame retardant with high heat distortion temperature
- » Trims easily with shears
- » Can be bent in a brake
- ».140" thick

**4'x8' & 3'x9.5' FLAT SHEETS  
READY TO CUT & FIT!**

## UNIVERSAL PLASTIC FLAT SHEETS

» Available in 5 colors **-W -B -G -CB -R**

4'x8' Sheet	30001-93051-X	\$142
3'x9.5' Sheet	30001-93151-X	\$125

**» REPLACE TRADITIONAL ALUMINUM WITH OUR HIGH-IMPACT PLASTIC!**

# DIRT LATE MODEL

## VINYL NOSE GRAPHIC ID KITS

- » **HIGH-TACK ADHESION:** Our outdoor durable vinyl with aggressive adhesive ensures that your nose graphics stay securely in place
- » **EXTREME DURABILITY:** Gloss laminated surface provides excellent protection to maintain their brilliant appearance even under the harshest conditions
- » **EASY APPLICATION:** Installing our graphics is a breeze! With our easy-to-follow application instructions, premium-grade vinyl & the all new MD3 Adhesion Promoter, you can achieve a smooth, professional looking install!



### CHEVROLET CAMARO

32133-44142 Evolution 2 & Evolution Nose ID Kit \$39



### CHEVROLET SS

32123-44141 Evolution 2 & Evolution Nose ID Kit \$39



### FORD MUSTANG

32323-44141 Evolution 2 & Evolution Nose ID Kit \$39



### TOYOTA CAMRY

740-410-ID Evolution 2, Evolution and Original Nose ID Kit \$39

**MOST ID KITS HAVE A UNIVERSAL FIT FOR ALL MD3 NOSE COMBOS**

### MD3 ADHESION PROMOTER

- » Specifically engineered adhesion promoter assures proper paint bonding to our special plastic
- » Other automotive grade primers on the market may not work at all or cause severe paint flaking
- » Improves adhesion of vinyl by enhancing the bond between adhesive on the vinyl and the substrate, for a more durable, long-lasting application
- » Comes in an aerosol spray can for quick and easy application
- » A single can coats approximately 5 individual parts

MD3 Adhesion Promoter 842 \$16



OLDER STYLE  BODY PANELS

» FOR OLDER DIRT LATE MODEL BODY PANELS, VISIT OUR WEBSITE!

\*\*PRICING SUBJECT TO CHANGE WITHOUT NOTICE\*\*

ABC LMS3 TRUCK PAVMOD OUTLAW LATE MODEL SPORTSMAN OLDER BODIES MD3 LATE MODEL MD3 MODIFIED NORTHEAST MOD STOCK CAR STREET STOCK TAZ PRO STOCK/MOD FUNNY CAR JR ROADSTER WINDOWS ACCESSORIES

ENGINEERED THROUGH THE DRIVER'S EYES



# **BODY MOUNTING TOOLS, BRACING & ACCESSORIES**

PRODUCTS ESSENTIAL FOR A COMPLETE,  
PROFESSIONAL LOOKING RACECAR



- » **MOUNTING TOOLS:** Ensure a professional body installation and easily replace panels throughout the season with a quick, hassle-free process
- » **UNIVERSAL BRACING:** Support body panels with these lightweight components essential to achieving astounding aerodynamics
- » **ACCESSORIES:** Everything you need to give your racecar that extra finishing touch!

## FIVE STAR PREMIUM AVEX STYLE MULTI-GRIP RIVETS

- » Five Star Rivets have a super-tight grip & won't spin while drilling
- » Grip range of up to 3/16" for 1/8" rivets & up to 1/2" for 3/16" rivets
- » Use long shank rivets for fastening fender, door, & windshield post together
- » Sold in quantities of 100 & 500; large head & small head with choice of 1/8" unpainted or 3/16" unpainted, white, black, blue, or red



SIZE/DESCRIPTION	QTY	SMALL	LARGE	
3/16", color	100	814x-100S	814x-100L	\$17
3/16", unpainted	100	816-100S	816-100L	\$17
3/16" long shank	100	816A-100S	N/A	\$19
3/16", color	500	814x-500S	814x-500L	\$53
3/16", unpainted	500	816-500S	816-500L	\$53
1/8", unpainted	100	815-100S	815-100L	\$13
1/8", unpainted	500	815-500S	815-500L	\$48

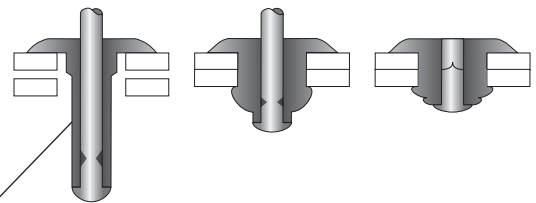

Provide a secure installation of your body panels with Five Star Rivets & Washers!

Five Star Rivets pull much tighter than other, cheaper rivets.

Washers are oversized to fit with Five Star Rivets and keep rivets tight no matter how much vibration

## FIVE STAR PREMIUM WASHERS

- » Five Star Premium Washers are lightweight & available in 3 sizes
- » Recommended for all plastic & composite body panels to keep them tight & prevent rivets from pulling out

TYPE	SIZE (I.D.)	SIZE (O.D.)	QTY		
Standard	1/8"	3/8"	100	817-100A	\$9
Standard	1/8"	3/8"	500	817-500A	\$25
Standard	3/16"	1/2"	100	818-100A	\$9
Standard	3/16"	1/2"	500	818-500A	\$25
Large	3/16"	3/4"	100	818-100AL	\$9
Large	3/16"	3/4"	500	818-500AL	\$25

## HIGH-IMPACT PLASTIC WEAR STRIPS

- » Height adjustable to seal the nose to the track to optimize aero & protection from wear
- » CNC-machined from Five Star's exclusive durable plastic
- » 2-piece kit fits either side
- » Install with Five Star Universal Body Mounting Kits
- » Available in 10 colors **-W -B -CB -R -Y -OR -FG -FO -FR -FY**

ABC NextGen, NextGen Late Model Stock Car	116" x 1-7/8"	11002-41551-x	\$35
ABC, LMSC, Straight-up Metal, Dirt Grand National	112" x 2-3/4"	000-400-x	\$35
S2 Sportsman	101" x 3"	664-400-x	\$42
Classic Street Stock (N/A IN FLUORESCENT COLORS)	120" x 5"	600-400-x	\$41
MD3 Street Stock, '88 Monte Carlo	119" x 3"	021-400-x	\$41
Modern Style Street Stock, North American Sportsman	107" x 3"	20002-41551-x	\$38



11002-41551-X

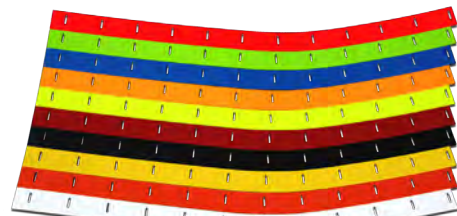

000-400-X



11002-41551-Y YELLOW WEAR STRIPS FULLY INSTALLED WITH 00001-72651 UNIVERSAL BODY MOUNTING KIT

KITS SPEED UP WEAR STRIP INSTALLATION & ALLOW FOR ADJUSTABILITY OF WEAR STRIP IF NEEDED



FULLY ASSEMBLED PLASTIC

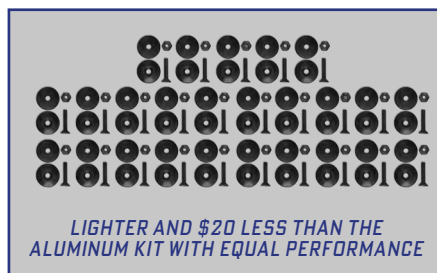

LIGHTER AND \$20 LESS THAN THE ALUMINUM KIT WITH EQUAL PERFORMANCE



FULLY ASSEMBLED ALUMINUM

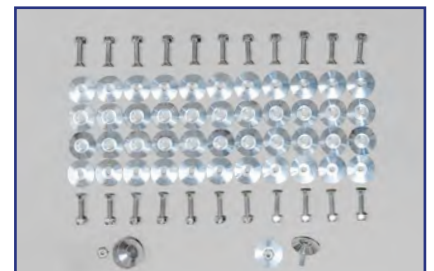

## UNIVERSAL BODY MOUNTING KITS

- » Universal fit that can be used anywhere on a racecar
- » Plastic Kit comes in all black & features Delrin washers that withstand repeated impact & stress
- » **Aluminum Kit includes:** 25 lightweight machined aluminum inner & outer 1" diameter washers, 25 nuts & 25 bolts. Kit weighs 12 oz
- » **Plastic Kit includes:** 25 ultra-durable plastic inner & outer 1" diameter washers, 25 lightweight aluminum nuts & 25 bolts. Kit weighs 7 oz

Aluminum: 25 sets (FULL INSTALLATION)	000-400K	\$49
Plastic: 25 sets (FULL INSTALLATION)	00001-72651	\$29

\*\*PRICING SUBJECT TO CHANGE WITHOUT NOTICE\*\*



## FRONT BUMPERS

- » Formed using CNC progressive tube bending technology
- » Fits the exact contour of Five Star noses for maximum protection and ease of installation
- » Formed from 1-3/4" OD round steel tubing
- » For a complete secure mount, it is recommended to install your bumpers with Five Star's Front Bumper Mounting Kits

ABC NEXTGEN		
Front, .065" steel	11002-71182	\$48
Front, .095" steel	11002-71185	\$48
Front, .095" steel (12" EXT RIGHT SIDE)	11002-71188	\$56
NEXTGEN LATE MODEL STOCK CAR		
Front, .065" steel	13002-71182	\$48
Front, .095" steel	13002-71185	\$48
Front, .095" steel (12" EXT RIGHT SIDE)	13002-71188	\$56
ORIGINAL ABC / ORIGINAL LMSC / STRAIGHT-UP METAL		
Front, .065" steel	660-7103	\$48
Front, .095" steel	660-7103B	\$48
Front, .095" steel (12" EXT RIGHT SIDE)	660-7103C	\$56

NORTH AMERICAN SPORTSMAN		
Front .065" steel	20002-71182	\$48
STREET STOCK '88 MONTE CARLO		
Front, .065" steel	600-7103	\$48
Front, .095" steel	600-7103B	\$48
Front, .065" steel	600-7101 (SQUARE)	\$48
STREET STOCK MD3 CAMARO, MUSTANG & CAMRY		
Front, .065" steel	20002-71182	\$48
DIRT GRAND NATIONAL		
Front, .065" steel	700-7103	\$48
Front, .095" steel	700-7103B	\$48
SHORT TRACK TRUCK COMMON		
Front, .065" steel	21001-71162	\$48

**FRONT BUMPER MOUNTING KIT (HIGHLIGHTED IN ORANGE)  
WITH BLACK ADJUSTABLE BUMPER SUPPORTS**



.095" STEEL BUMPER WITH  
12" EXTENSION FOR  
ADDITIONAL RIGHT FRONT  
PROTECTION

**NEW!**  
LIGHTWEIGHT EXTRUDED ALUMINUM



CLOSE-UP OF  
ADJUSTABLE  
BUMPER SUPPORT

## FRONT BUMPER MOUNTING KITS

- » Everything you need to mount the bumper to the chassis
- » Upgraded lightweight, extruded, black anodized aluminum adjustable bumper supports
- » Make quick, easy, & accurate adjustments with a 5/8" wrench
- » Universal design for all Five Star Short Track Noses
- » Fits all chassis configurations
- » **Complete Kit includes:** 2 aluminum threaded bumper support tubes; 4 clevis, eye bolts & nuts; 2 1-1/2" pieces of square tubing, notched on one end; 2 pieces of flat stock; 4 1-1/2" bolts & stover nuts, 2 pivoting chassis mounts with 2-1/2" bolts & nuts
- » **Adjustable Bumper Support Kit includes:** 2 extruded, threaded, black anodized aluminum adjustable tubes; 4 eye bolts & nuts; 4 1-1/2" bolts and stover nuts
- » **Replacement Kit includes:** 2 1-1/2" square pieces of square tubing; 2 pieces of flat stock; 1/2" nuts & bolts & mounting tabs

Complete Kit	10001-72721	\$132
Adjustable Bumper Support Kit	10001-72733	\$35
Replacement Kit	802-4	\$87

### 10001-72721 | COMPLETE KIT

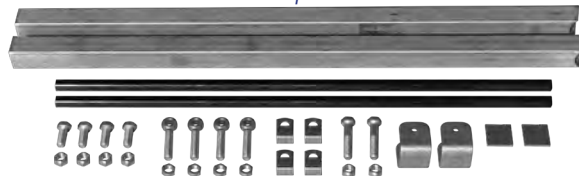

### 10001-72733 | ADJUSTABLE BUMPER SUPPORTS KIT



### 802-4 | REPLACEMENT KIT



## HOOD PIN BRACKETS

- » Preformed to fit the nose & hood precisely
- » Aluminum option weighs less than half of steel option
- » Both options include welded-on tabs for hood pin placement
- » Aluminum bracket includes welded on mounting tabs on each end to brace to the front bumper mounting kit for added support
- » ABC NextGen / NextGen Late Model Stock Car require 4 hood pins & Older Style ABC and Older Style LMSC require 5 hood pins
- » Available in 1/2" & 3/4" options, & will work with both 1/2" & 3/8" hood pins

ABC NEXTGEN / NEXTGEN LATE MODEL STOCK CAR		
3/4" OD, aluminum (COMMON)	11002-34333	\$66
3/4" OD, steel (COMMON)	11002-34331	\$35
ORIGINAL ABC / ORIGINAL LATE MODEL STOCK CAR		
3/4" OD, aluminum (EXCLUDES FORD)	660-411A-HPB	\$66
3/4" OD, aluminum (FORD)	570-411A-HPB	\$66
3/4" OD, steel (EXCLUDES FORD)	660-411-HPB	\$35
3/4" OD, steel (FORD)	570-411-HPB	\$35
1/2" OD, steel (EXCLUDES FORD)	660-410-HPB	\$35
1/2" OD, steel (FORD)	570-410-HPB	\$35
NORTH AMERICAN SPORTSMAN		
3/4" OD, steel	20002-34331	\$35

S2 SPORTSMAN		
3/4" OD, steel	664-411-HPB	\$35
1/2" OD, steel	664-410-HPB	\$35
SHORT TRACK TRUCK		
1/2" OD, steel (COMMON)	21001-34131	\$35
STREET STOCK		
3/4" OD, steel ('88 MONTE CARLO)	600-410-HPB	\$35
3/4" OD, steel (CAMARO, MUSTANG & CAMRY)	20002-34331	\$35
DIRT GRAND NATIONAL		
1/2" OD, steel (EXCLUDES FORD)	700-410-HPB	\$35
1/2" OD, steel (FORD)	703-410-HPB	\$35

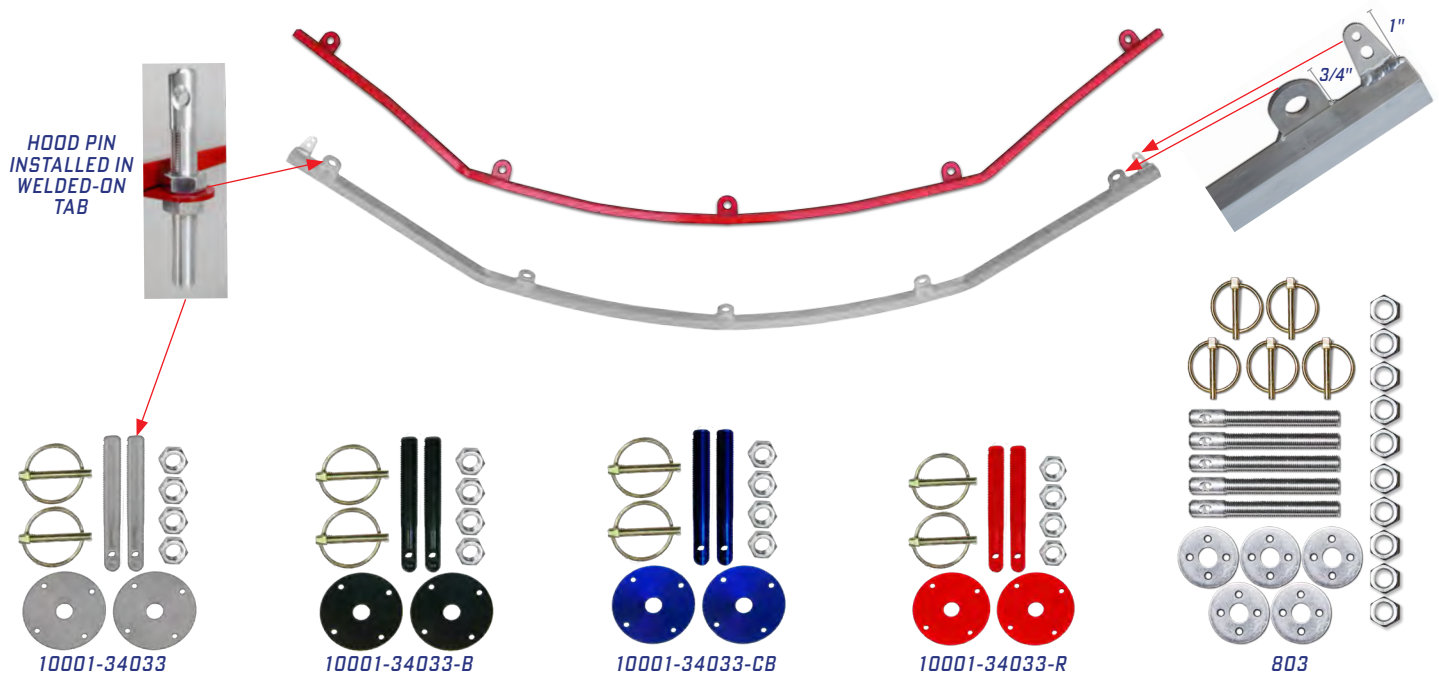

## HOOD PIN KITS

- » **Secure your hood in style!**
- » 3/8" Hood Pin Kit: 2 pack kit includes: 2 lightweight anodized & gun-drilled aluminum pins (half the weight of standard), 2 aluminum scuff plates, 2 flip-over steel clips, 4 jam nuts
- » 1/2" Hood Pin Kit: 5 pack kit includes: 5 lightweight aluminum pins, 5 aluminum scuff plates, 5 flip-over style steel clips, 10 jam nuts

3/8" Hood Pin Kit, Silver	10001-34033	\$16
3/8" Hood Pin Kit, Black	10001-34033-B	\$16
3/8" Hood Pin Kit, Blue	10001-34033-CB	\$16
3/8" Hood Pin Kit, Red	10001-34033-R	\$16
1/2" Hood Pin Kit, 5 pack	803	\$38
1/2" Scuff Plate, aluminum	803-PS	\$2

\*\*PRICING SUBJECT TO CHANGE WITHOUT NOTICE\*\*

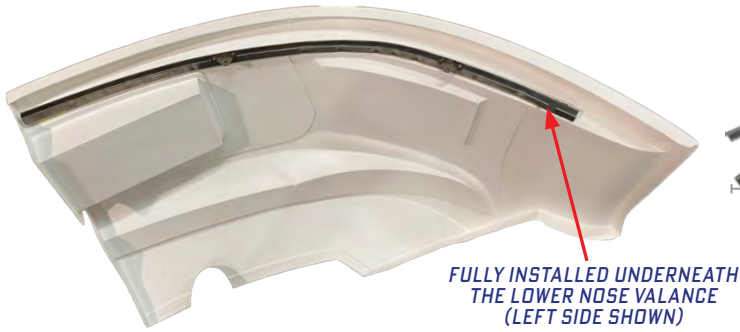

FULLY INSTALLED UNDERNEATH THE LOWER NOSE VALANCE (LEFT SIDE SHOWN)



ALUMINUM  
11002-75733

42-1/2"

## LOWER NOSE SUPPORT BRACKET

- » Mounts under the lower valance to maintain strength & structural integrity for the nose under high speeds
- » Choose from lightweight aluminum or steel bracket
- » Fits left & right half of nose
- » 2-piece kit includes: 2 brackets with 2 attached mounting tabs for ease of installation

Aluminum	11002-75733	\$49
Steel	11002-75731	\$44

FITS THESE BODY STYLES: ABC NEXTGEN AND NEXTGEN LATE MODEL STOCK CAR



000-500: MOUNT TO INSIDE OF WEAR STRIPS WITH A FIVE STAR UNIVERSAL BODY MOUNTING KIT



11002-75333: MOUNT VERTICALLY ON NOSE SIDE

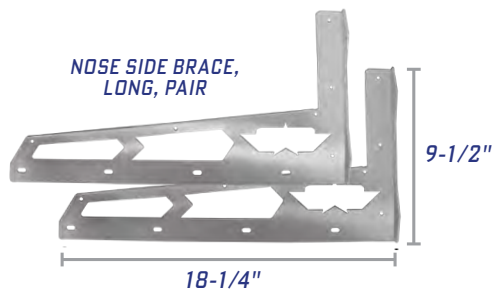

NOSE SIDE BRACE,  
LONG, PAIR

9-1/2"

18-1/4"

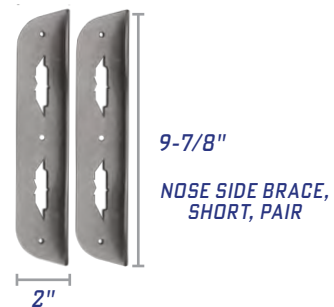

9-7/8"

NOSE SIDE BRACE,  
SHORT, PAIR

2"

## ALUMINUM NOSE SIDE BRACES

- » Provides structure to an aero critical part of the car
- » Laser-cut aluminum is pre-drilled for riveting to the nose & for mounting body braces
- » Works great with Five Star's Premium Adjustable Body Braces (PN 10001-759XX ON PAGE 165)
- » Each pair weighs less than a pound

Nose Side Brace, Long, pair	000-500	\$39
-----------------------------	---------	------

FITS THESE BODY STYLES: OLDER STYLE ABC AND OLDER STYLE LMSC, FIBERGLASS SPORTSMAN, STRAIGHT UP METAL, DIRT GRAND NATIONAL, MINI STOCK MUSTANG

Nose Side Brace, Short, pair	11002-75333	\$15
------------------------------	-------------	------

FITS THESE BODY STYLES: ABC NEXTGEN, NORTH AMERICAN SPORTSMAN, NEXTGEN LATE MODEL STOCK CAR, SHORT TRACK TRUCK

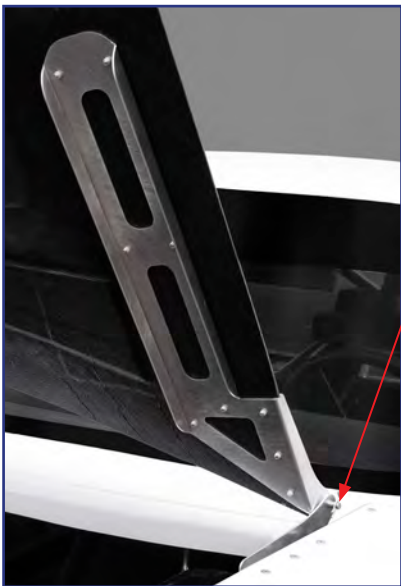

FULLY INSTALLED 11002-73333

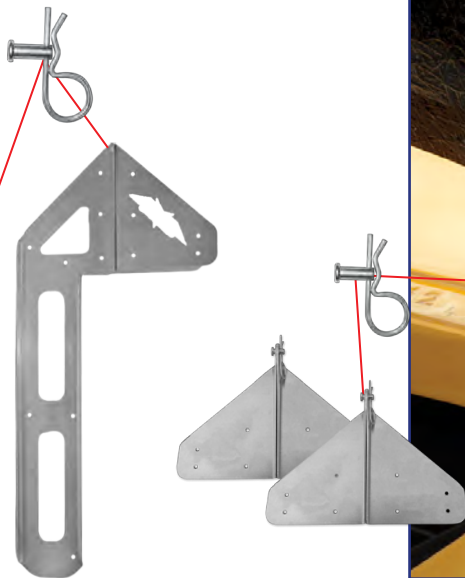

FULLY INSTALLED 000-33H

### ALUMINUM HOOD HINGE KITS

- » Hinged hoods create easy access to the engine compartment
- » Long Hinge Kit includes: Laser cut aluminum hinge, pin, & clip assembly. 1 kit is required to complete the installation of a hood
- » Short Hinge Kit includes: Laser cut aluminum hinge, pin, & clip assembly. 2 kits are required to complete the installation of a hood

Hood Hinge, short	000-33H	\$17
Hood Hinge, long	11002-73333	\$39
Replacement Pin & Clip	000-33HP	\$5

### ALUMINUM HOOD PROP

- » Makes for the easiest access to the engine compartment
- » Made of machined lightweight aluminum
- » Used for hinged hoods
- » Sold as a pair, 2 needed for installation

Hood Prop, pair	000-3400	\$67
-----------------	----------	------



FULLY INSTALLED 000-3400

\*\*PRICING SUBJECT TO CHANGE WITHOUT NOTICE\*\*



000-409 FULLY INSTALLED



STREET STOCK  
FLEXIBLE RADIATOR DUCT

## FLEXIBLE RADIATOR DUCTS

- » Retains air flow functionality even after frontal impact & reduces the risk of radiator damage
- » Flexible Radiator Duct replaces rigid metal ductwork with a custom canvas bag & aluminum or plastic framing
- » Long lasting & durable
- » Simple installation
- » Select your model by measuring the size of the radiator core
- » Features molded plastic radiator mounting flanges
- » Plastic Nose Air Inlet Extension (PN 000-409-NP) used for 000-409 Radiator Ducts only

### Street Stock (PN 600-409)

- » Fits both '88 Monte Carlo Noses
- » Captures air from both the upper & lower nose grill openings

ABC/NORTH AMERICAN SPORTSMAN/S2/SU		STYLE/SIZE	ABC NEXTGEN/NEXTGEN LMSC	
000-409-1	\$169	Griffin, 22-3/8" x 17-7/8"	11002-42120	\$135
000-409-2	\$169	Howe, 24-1/4" x 18-1/2"	11002-42121	\$135
000-409-3	\$169	Howe, 22-1/4" x 18-3/4"	11002-42122	\$135
000-409-4	\$169	C & R, 22-1/4" x 17-3/4"	11002-42123	\$135
000-409-5	\$169	C & R, 24-1/4" x 17-3/4"	11002-42124	\$135
000-409-6	\$169	Howe, 27-1/4" x 18-1/2"	11002-42125	\$135
LMSC		STYLE/SIZE	STREET STOCK	
000-409-5	\$169	C & R, 24-1/4" x 17-3/4"	600-409-2	\$156
000-409-6	\$169	Howe, 27-1/4" x 18-1/2"	600-409-6	\$156

## PLASTIC BRAKE DUCT KIT

- » Provide peak airflow to cool your brakes
- » Universal fit for all noses at correct angle; fits either side
- » Fits 3" & 4" Brake Duct hose
- » Crimped 3/16" stainless steel screen to keep debris out
- » Kit includes: pre-cut stainless steel screen, rivets & washers
- » Weighs 6 oz

Brake Duct Kit                      000-412D                      \$35

FITS THESE BODY STYLES: ABC NEXTGEN, ABC, NEXTGEN LMSC, LMSC, S2, SHORT TRACK TRUCK, NORTH AMERICAN SPORTSMAN, STRAIGHT-UP METAL, STREET STOCK

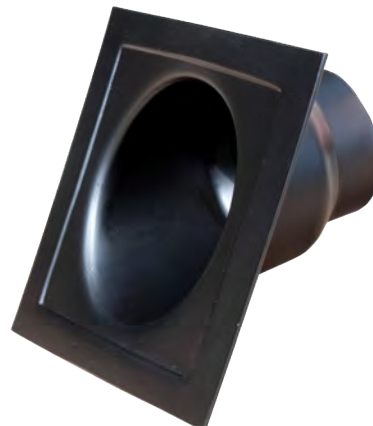

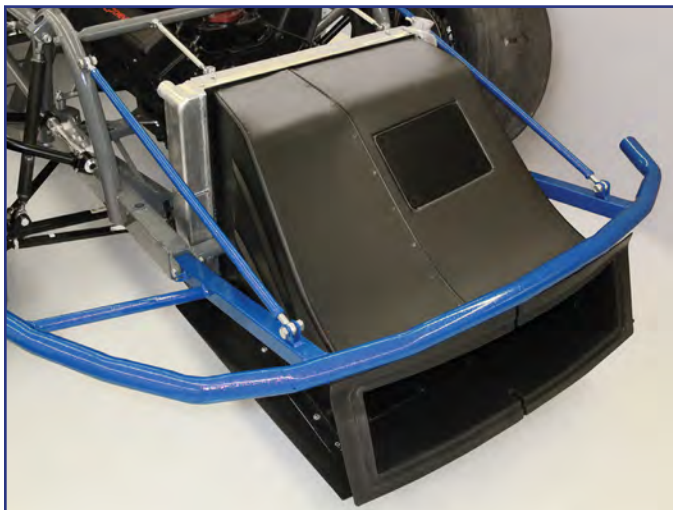

000-408 FULLY INSTALLED

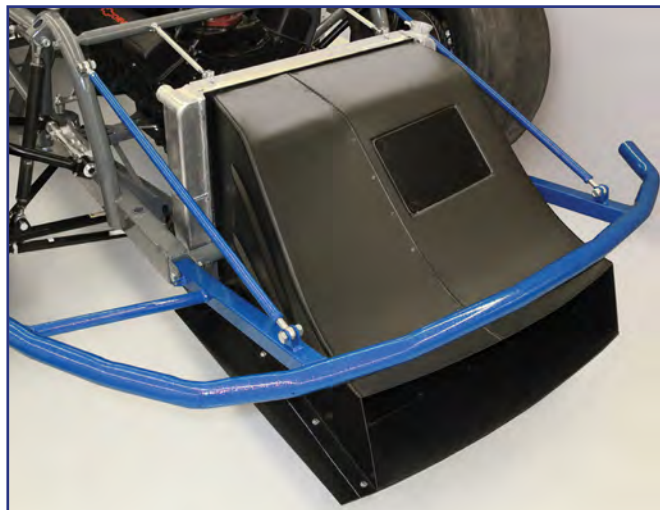

11002-42151 FULLY INSTALLED

### MOLDED PLASTIC RADIATOR DUCTS

- » Universal multi piece design for easy installation to fit any chassis and radiator size/offset
- » High air flow design
- » Premium molded plastic weighs less than 13 lbs
- » More durable and easier to install than other sheet metal air boxes
- » 100% positive seal from nose to radiator
- » Access panel for easy debris clean-out
- » **Kit includes:** 2-piece molded plastic radiator duct, 1 molded plastic bottom, 1 aluminum cover kit with 4 black rivets, 1 plastic nose air inlet extension, and 1 molded plastic frame *(THE PLASTIC NOSE AIR INLET EXTENSION IS FOR THE UNIVERSAL SHORT TRACK BODY. IT IS NOT NEEDED FOR ABC NEXTGEN AND NEXTGEN LATE MODEL STOCK CAR)*

Universal Short Track Bodies*	000-408	\$221
ABC NextGen / NextGen Late Model Stock Car	11002-42151 <i>(AIR INLET EXTENSION NOT REQUIRED)</i>	\$185
Radiator Duct, 2-piece	000-408-D	\$68
Radiator Duct, Bottom	000-408-B	\$54
Radiator Duct, Cover Kit	000-408-A	\$15
Radiator Duct, Frame	000-408-R	\$36

\*FITS THESE BODY STYLES: OLDER STYLE ABC, OLDER STYLE LMSC, NORTH AMERICAN SPORTSMAN, S2 SPORTSMAN, STRAIGHT-UP METAL, STREET STOCK



### PLASTIC NOSE AIR INLET EXTENSION

- » Ideal for racers who build their own aluminum radiator box
- » Molded Plastic construction weighs less than 2 lbs
- » The Plastic Nose Air Inlet Extension is not needed for the ABC NextGen & NextGen Late Model Stock Car
- » Item already included with 000-408 Molded Plastic Radiator Duct & 000-409 Flexible Radiator Duct

Plastic Nose Air Inlet Extension	000-409-NP	\$36
----------------------------------	------------	------

FITS THESE BODY STYLES: ABC, LMSC, NORTH AMERICAN SPORTSMAN, S2 SPORTSMAN, STRAIGHT-UP METAL



SHOWN MOUNTED FROM INSIDE OF NOSE



\*\*PRICING SUBJECT TO CHANGE WITHOUT NOTICE\*\*

## COWL INDUCTION COLD AIR BOXES

### FLOW BENCH TESTED FOR PEAK AIRFLOW

- » Advanced lightweight composite construction with flame retardant gray resin
- » Comparable in weight to carbon fiber alternatives
- » Designed for maximum airflow using air filters as short as 3"
- » Increased distributor & under hood clearance
- » Fits a standard 14" filter element

4 Barrel, 0° Angle (Offset)	10001-53401	\$564
4 Barrel, 3° Angle (Standard)	10001-53431	\$564
2 Barrel, standard	10001-53201	\$426
2 Barrel, offset	10001-53202	\$406

NOTE: FOR OLDER STYLE 51-SERIES COLD AIR BOXES CALL FIVE STAR 262.877.2171



FULLY INSTALLED COLD AIR BOX



2 BARREL COLD AIR BOX

### 4 BARREL AIR BOXES:

- » Available in 0° & 3° to ensure a proper, level fit
- » Feature a patented machined adapter ring for clean airflow, better fit, & durability
- » 3° Air box is commonly used for short track late models
- » How to determine air box angle option:
  - » Set car at proper ride height
  - » Place angle finder on carburetor to determine which air box option fits best



4 BARREL COLD AIR BOX

### 2 BARREL OFFSET AIR BOX:

- » Offset 2-barrel air box is for engines with a larger setback
- » Designed to allow the element to be flat across the back for engine setback & clearance in the cowl
- » Fits a standard 3-1/2" x 14" filter element

### 2 BBL AIR BOX IS DYNO TESTED

"The results were outstanding! Five Star's 2bbl Air Box was 10 HP & 16 ft lbs of torque better than the old one!"

-SHANE HARDING  
HARDING MOTORSPORTS CHASSIS

### PATENTED FLOW DESIGN 4 BBL UNIQUE HIGH FLOW DESIGN

CNC-machined aluminum ring (laminated into the air box) fits perfectly on carburetor to maximize airflow

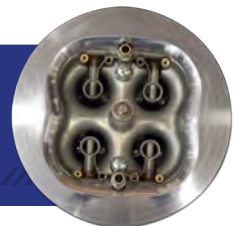

SCAN HERE TO  SHOP ONLINE

» FOR INDIVIDUAL PART DIMENSIONS, VISIT [FIVESTARBODIES.COM](http://FIVESTARBODIES.COM)

## REFLECTIVE HEAT SHIELD

- » Thin reflective adhesive film reflects over 90% of radiant heat from the engine, up to 500°F
- » Easy to cut and install to protect any part of the racecar from high heat:
  - » All Cold Air Boxes
  - » Foot Boxes
  - » Fuel Filter Housings
  - » Interiors
  - » Shock Canisters
  - » And more

Cold Air Box Kit, 4 oz	000-52HS	\$74
5'x26" Sheet, 3oz per ft	000-5HS	\$74



FULLY INSTALLED  
COLD AIR BOX KIT  
000-52HS

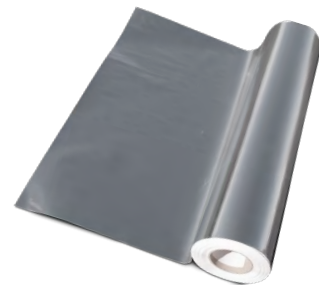

5' LENGTH X 26" WIDE SHEETS  
000-5HS

## COWL AIR INSERT

- » Designed for maximum airflow directly into the cold air box
- » Made of Ultraglass composite and oversized for left and right adjustment to properly fit the air box
- » Opening meets all sanctioning regulations
- » Included with ABC Body Packages
- » Available in 4 colors

		<b>-W -B</b>	<b>-CB -R</b>
Cowl Air Insert	661-5100A-X	\$72	\$75

FITS THESE BODY STYLES: ABC NEXTGEN, ABC, NORTH AMERICAN SPORTSMAN, S2, STRAIGHT-UP METAL, SHORT TRACK TRUCK



## COWL AIR DEFLECTORS

- » Smoothly flows air from cowl air opening into cold air box
- » Black Ultraglass Composite
- » Rounded Bottom: 20" x 7", Square Bottom: 20-1/8" x 7-1/2"
- » Fits all air box styles listed on page 154
- » 000-5100A-B available & fits older style 51-series air boxes

Rounded Bottom	000-5200A	\$59
Square Bottom	000-5100A-B	\$76

ROUNDED BOTTOM | 000-5200A



SQUARE BOTTOM | 000-5100A-B



## ALUMINUM COWL BRACKET TABS

- » Create a positive seal by holding hood flat at the cowl
- » Mounts along front flange of cowl panel
- » Fits 3/8" or 1/2" hood pins
- » Kit is included with cowl panels
- » Kit includes: 4 laser-cut aluminum tabs weighing 0.5 oz each

Cowl Bracket Tabs	000-510	\$13
-------------------	---------	------





## REAR BUMPERS

- » Formed using CNC progressive tube bending technology
- » Fits the exact contour of Five Star bumper covers for maximum protection and ease of installation
- » Formed from 1-3/4" OD round steel tubing
- » For a complete secure mount, it is recommended to install your bumpers with Five Star's Rear Bumper Mounting Kits

ABC NextGen, .065" steel	11002-71682	\$48
NextGen Late Model Stock Car, .065" steel	11002-71682	\$48
ABC / LMSC / Straight-Up Metal, .065" steel	570-7503	\$48
North American Sportsman, .065" steel	11002-71682	\$48

Street Stock '88 Monte Carlo, .065" steel	600-7501	\$48
Dirt Grand National, .065" steel	570-7503	\$48
Short Track Truck, .065" steel	T000-7503	\$48

**REAR BUMPER FULLY INSTALLED WITH HEIGHT ADJUSTABLE MOUNTING KIT  
(HIGHLIGHTED IN ORANGE)**

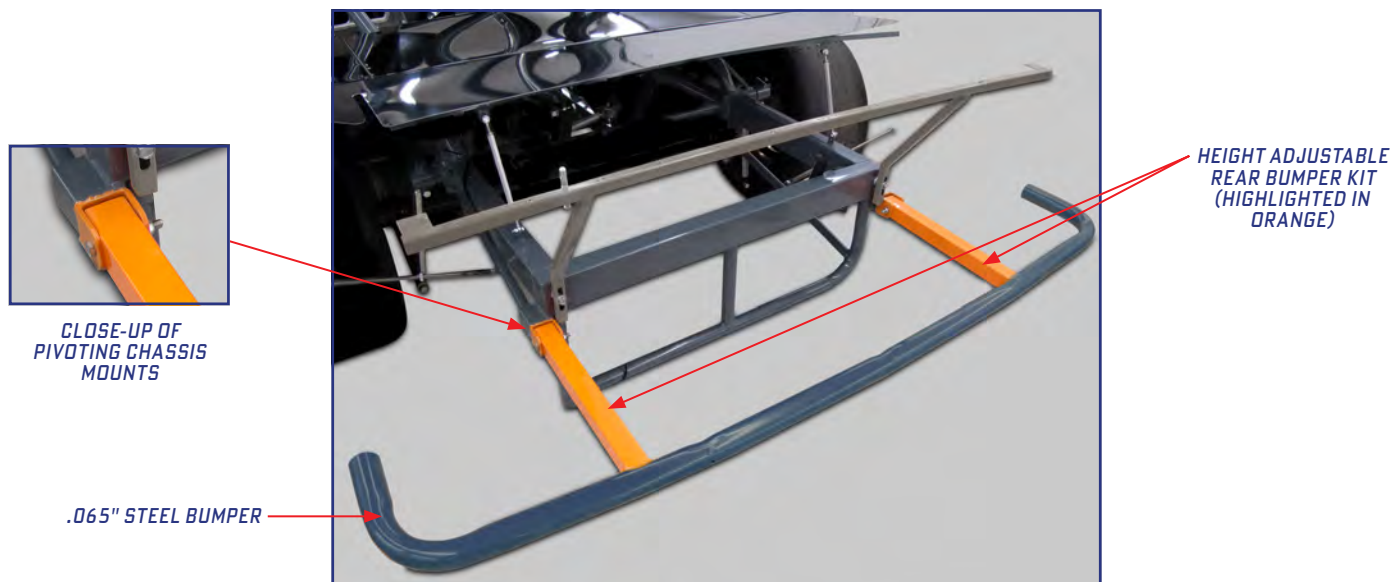

## REAR BUMPER MOUNTING KITS

- » Everything you need to mount the bumper to the chassis
- » Universal design for all Five Star Short Track Bumper Covers
- » Fits all chassis configurations
- » Available in two options:
  - » **Height-Adjustable Kit: (PN 802-2S)** Allows for several different mounting options and pivots to allow precise adjustments to the height of the rear bumper cover  
**Kit includes:** 2 pivoting chassis mounts; 1 36" long 1-1/2" square piece of tubing; 2 pieces of flat stock; 2 1/2" nuts and bolts
  - » **Non-Adjustable Kit: (PN 802-2)** Make your bumper a bolt-on component  
**Kit includes:** 2 3' long x 1-3/4" thick pieces of round tubing, 2 pieces of .120" thick square tubing and 5/16" hex bolts & nuts

Height-adjustable Kit	802-2S	\$49
Non-adjustable Kit	802-2	\$43

## STEEL REAR DECK MOUNTING KIT

- » Everything you need to properly fabricate a perfect fitting brace from the rear bumper cover & deck lid to the chassis
- » **Deck Lid Bracket:** (PN 660-450-DLB) supports your rear body clip by securing it to the rear bumper cover & quarter panel.  
Kit includes: 2 tabs for hood pins; weighs 36 oz
- » **Deck Lid Height Slider Kit:** (PN 802-3) allows for easy adjustment of spoiler height with 3-1/2" of deck lid height adjustability.  
Kit includes: 2 pieces slotted 3/4" square tubing, 3/8" hex bolts & nuts
- » **Deck Lid Hold-down Kit:** (NOT SOLD SEPARATELY) allows for a removable deck lid.  
Kit includes: 1 aluminum deck lid hold-down strip, 2 mounting tabs, 4 jam nuts, 2 3/8" gun-drilled, anodized aluminum pins & scuff plates (SILVER), & 2 flip-over steel clips

Rear Deck Mounting Kit*	660-450-RDK	\$89
Replacement Deck Lid Bracket*	660-450-DLB	\$32
Replacement Deck Lid Height Slider Kit*	802-3	\$19
Replacement Deck Lid Hold-Down Strip	XM 000-310H-X	
Replacement Deck Lid Hold-Down Hardware Kit	XA 000-310H-K	

FITS THESE BODY STYLES: ABC NEXTGEN, ABC, NEXTGEN LMSC, LMSC, NORTH AMERICAN SPORTSMAN, S2, STRAIGHT-UP METAL, STREET STOCK, DIRT GRAND NATIONAL, MINI STOCK

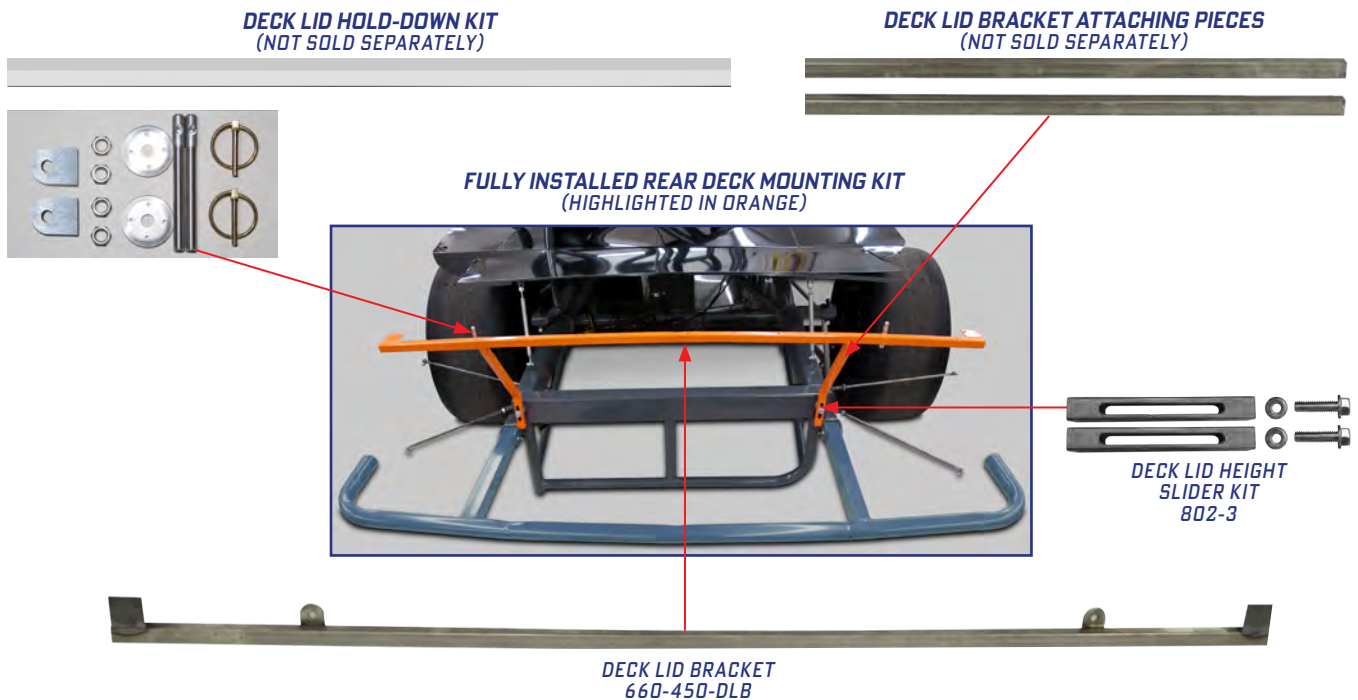

**ONLY WEIGHS 17 OZ**  
LESS THAN HALF THE WEIGHT OF STEEL



## ALUMINUM DECK LID BRACKET

- » This is a premium upgrade from the steel deck lid bracket to save weight without sacrificing strength
- » Mounts to the rear bumper cover and quarter panel, includes 2 tabs for hood pins and 4 tabs for chassis mounting options
- » Complete the combination with our 3/8" Hood Pin Kit (PN 10001-34033-X)

Aluminum Deck Lid Bracket	11002-75633	\$49
---------------------------	-------------	------

FITS THESE BODY STYLES: ABC NEXTGEN, ABC, NEXTGEN LMSC, LMSC, NORTH AMERICAN SPORTSMAN, S2, STRAIGHT-UP METAL, STREET STOCK, DIRT GRAND NATIONAL, MINI STOCK

## REPLACEMENT SPOILER BRACKETS & BLADES

- » 2-piece polycarbonate blade with 2-piece aluminum bracket, your choice of unpainted or black powder-coated
- » Available in 90, 70 and 55 degree angles

ABC NextGen / NA Sportsman	5" (90°)		5" (70°)		6-1/2" (90°)		6-1/2" (70°)					
Brackets, replacement, aluminum, 60"	11002-47369-1	11002-47367-1	11002-47369-1	11002-47367-1	11002-47369-1	11002-47367-1	11002-47369-1	11002-47367-1				
Brackets, replacement, aluminum, 64-1/2"	11002-47389-1	11002-47387-1	11002-47389-1	11002-47387-1	11002-47389-1	11002-47387-1	11002-47389-1	11002-47387-1				
Brackets, replacement, aluminum, black, 60"	11002-47369-1B	11002-47367-1B	11002-47369-1B	11002-47367-1B	11002-47369-1B	11002-47367-1B	11002-47369-1B	11002-47367-1B				
Brackets, replacement, aluminum, black, 64-1/2"	11002-47389-1B	11002-47387-1B	11002-47389-1B	11002-47387-1B	11002-47389-1B	11002-47387-1B	11002-47389-1B	11002-47387-1B				
Blades, replacement, polycarbonate, 60"	11002-47359-2	11002-47357-2	11002-47359-2	11002-47357-2	11002-47359-2	11002-47357-2	11002-47359-2	11002-47357-2				
Blades, replacement, polycarbonate, 64-1/2"	11002-47479-2	11002-47477-2	11002-47479-2	11002-47477-2	11002-47479-2	11002-47477-2	11002-47479-2	11002-47477-2				
ABC / S2 / Straight-Up Metal	5" (90°)		5" (70°)		5" (55°)		6-1/2" (90°)		6-1/2" (70°)		6-1/2" (55°)	
Brackets, aluminum	661-6739-1	661-6737-1	661-6735-1	661-6739-1	661-6737-1	661-6735-1	661-6739-1	661-6737-1	661-6735-1	661-6739-1	661-6737-1	661-6735-1
Brackets, aluminum, black	661-6739-1B	661-6737-1B	661-6735-1B	661-6739-1B	661-6737-1B	661-6735-1B	661-6739-1B	661-6737-1B	661-6735-1B	661-6739-1B	661-6737-1B	661-6735-1B
Blades, polycarbonate	661-6749-2	661-6747-2	661-6745-2	661-6739-2	661-6737-2	661-6735-2	661-6739-2	661-6737-2	661-6735-2	661-6739-2	661-6737-2	661-6735-2



UNPAINTED BRACKETS WITH BLADES



BLACK POWDER-COATED BRACKETS WITH BLADES, FULLY INSTALLED USING 807-3 ADJUSTABLE BODY BRACES (SOLD SEPARATELY, SEE PG XXX)



SPOILER IS FULLY INSTALLED ON THE BUMPER COVER USING THE SPOILER MOUNTING KIT

## ALUMINUM SPOILER MOUNTING KIT

- » Everything needed to mount the polycarbonate spoiler blade to the bracket, & the bracket to the bumper cover
- » **76-piece kit includes:** 32 lightweight machined aluminum inner & outer washers, 22 flat head socket screws & 22 locknuts

Spoiler Mounting Kit	000-67K	\$33
----------------------	---------	------

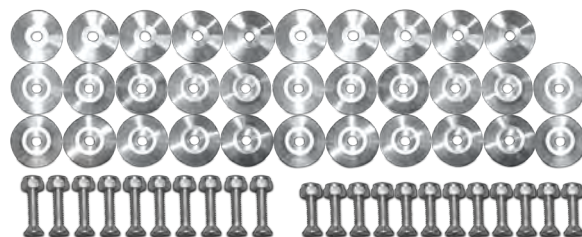

## POLYCARBONATE RUB RAIL

- » Protect your vinyl without hiding it!
- » Attach to side of body to eliminate tire marks on fenders, doors, and quarter panels
- » Ultra-durable polycarbonate to absorb impact
- » Can be trimmed to fit your application

Rub Rail, 75" long

000-2100

\$19 ea



FULLY MOUNTED POLYCARBONATE RUB RAIL



PLASTIC VERSION INCLUDES CURVED EDGE FOR OPTIMUM AERODYNAMICS



000-5501P-W  
MOLDED PLASTIC STANDARD ROCKER PANEL



ALUMINUM VERSION HAS ENDS ROLLED BY SPECIAL PROCESS, ENHANCING AIR FLOW



000-5501A-W  
ALUMINUM STANDARD ROCKER PANEL



000-5500A-W  
ALUMINUM STRAIGHT ROCKER PANEL

EDGES ARE LEFT STRAIGHT, NOT CURVED

## MOLDED PLASTIC & ALUMINUM ROCKER PANELS

- » Mounts below the fender / door / quarter panel area and fits either side
- » Curved edges provide optimum aerodynamics and adds structural integrity to side body panels
- » Manufactured in high-impact plastic and lightweight aluminum
- » Available in 5 color options

			-W -B	-CB -R
High-Impact Plastic (N/A IN YELLOW)	000-5501P-x	82"x 5"	\$33	\$38
Aluminum	000-5501A-x	77-3/4" x 5"	\$39	\$39
Aluminum, straight	000-5500A-x	79" x 4-3/4"	\$39	n/a

FITS THESE BODY STYLES: ABC NEXTGEN, ABC, NEXTGEN LMSC, LMSC, NORTH AMERICAN SPORTSMAN, S2 SPORTSMAN, SHORT TRACK TRUCK, STREET STOCK

## ALUMINUM WINDOW BRACES

- » Strongest window braces on the market
- » Designed to the exact contour of your Five Star windows
- » Made of premium high-strength aluminum with flat black powder-coated finish
- » Foam-padded surface won't scratch your windows
- » Pre-drilled holes to mount adjustable bracing from the interior dash
- » **Kit includes:** 3 aluminum braces & installation hardware

Windshield Brace Kits		C=Center, L=Left, R=Right, O=outer, all 1" Wide	
ABC Next Gen Windshield Brace Kit	11002-76333	24-1/8"(C), 24-1/4"(L), 24-1/2"(R)	\$84
NextGen Late Model Stock Car Windshield Brace Kit	13002-76333	25-5/8"(C), 25-1/2"(L), 25-5/8"(R)	\$84
ABC/LMSC/Straight-Up Metal Windshield Brace Kit	564-6301	28-5/8" x 1"	\$84
North American Sportsman Windshield Brace Kit	12001-76333	26" x 1"	\$84
Pavement Modified Windshield Brace Kit	020-6301	26-1/2" x 1"	\$84
Short Track Truck Windshield Brace Kit	21001-76333	31-5/8"(C), 31-3/4"(L), 31-1/2"(R)	\$84
Rear Window Brace Kits		C=Center, L=Left, R=Right, O=outer, all 1" Wide	
ABC NextGen Rear Window Brace Kit	11002-76133	30-7/8"(C), 30-5/8"(O)	\$84
NextGen Late Model Stock Car Rear Window Brace Kit	11002-76133	30-7/8"(C), 30-5/8" (O)	\$84
ABC/LMSC/Straight-Up Metal Rear Window Brace Kit	674-6101	32" x 1"	\$84
North American Sportsman Rear Window Brace Kit	12001-76133	31-1/4"(C), 30-1/2"(O)	\$84
Pavement Modified Rear Window Brace Kit	020-6101	34" x 1"	\$84

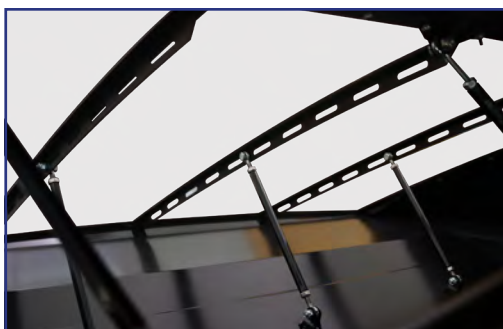

FULLY INSTALLED WINDOW BRACE KIT

WEIGHS LESS THAN 2 LBS



**IMPORTANT:**  
USING RIVETS APPLIES TOO MUCH PRESSURE TO YOUR WINDOW & WILL FRACTURE THE POLYCARBONATE

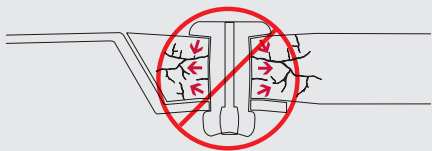

### WINDOW INSTALLATION KIT

- » Using proper hardware provides the perfect fit & helps to increase the life of your window
- » Black oxide coated to prevent rust
- » Enough hardware to install a complete set of windows on one car
- » **Kit includes:** 120 6-32 1/2" & 16 6-32 3/4" flat head socket screws, 136 6-32 nylon locknuts, 1 long-arm hex key & 9/64" drill bit

Window Installation Kit 805 \$27

### WINDOW INSTALLATION COUNTERSINK DRILL BIT

- » 3/8" diameter steel bit, 1/4" shank
- » Use this drill bit to countersink holes perfectly for window screw installation into polycarbonate!
- » Ensures a flush fit and a secure hold every time
- » Not required for precut to fit, beveled, & drilled windows

Drill Bit 805-1 \$19

## RIGHT SIDE DOOR SUPPORT

- » Easily adjust your right side door to the proper width
- » This piece connects your right side door bar to your door
- » .080" thick aluminum laser-cut to reduce weight
- » Laser cutting allows for precise, consistent shape & weight
- » Slotted mounting holes allow for easy inner & outer door adjustments to proper width
- » Weighs under 2 lbs

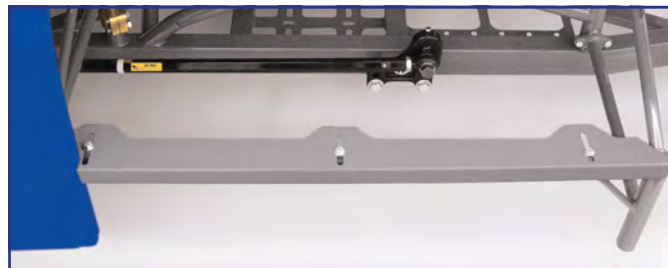

FULLY INSTALLED 11002-75533

Aluminum Door Support	11002-75533	\$30
-----------------------	-------------	------

FITS THESE BODY STYLES: ABC NEXTGEN, ABC, S2 SPORTSMAN, NORTH AMERICAN SPORTSMAN, SHORT TRACK TRUCK, DIRT GRAND NATIONAL



## DRILL BIT KIT

- » Special double-ended drill bits
- » These bits drill a slightly larger diameter hole than a standard 1/8" or 3/16" bit to prevent stress cracks in the material
- » The short drill shaft makes drilling in tight places easier
- » Kit includes: 2 9/64" double-ended drill bits & 2 #30 double-ended drill bits

Drill Bit Kit	806	\$18
---------------	-----	------

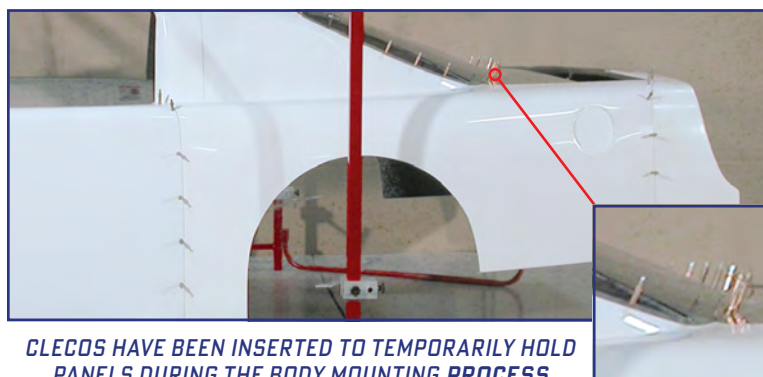

CLECOS HAVE BEEN INSERTED TO TEMPORARILY HOLD PANELS DURING THE BODY MOUNTING PROCESS

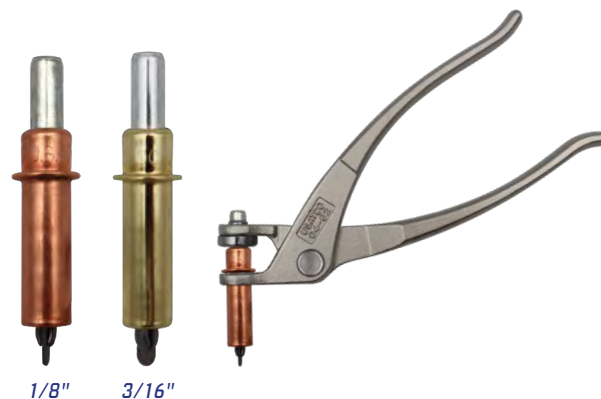

## CLECO KIT & PLIERS

- » Precision has never been this easy! Cleco Pliers & Cleco Fasteners ensure perfect alignment every time
- » Clecos can be easily inserted with the Cleco Pliers to temporarily hold panels during the body mounting process
- » Our Cleco pliers are engineered for comfort & built to last, ensuring a secure grip & maximum control
- » Choice of 1/8" 25-piece Cleco Kit or 3/16" 25-piece Cleco Kit

1/8" Single Spade Kit, long	812	\$28
3/16" Single Spade Kit, long	813	\$36
Cleco Pliers	811	\$12

\*\*PRICING SUBJECT TO CHANGE WITHOUT NOTICE\*\*

## FENDER-TO-NOSE BACK-UP PLATES KIT

- » Reinforces the flange where the fenders mount to the nose
- » Pre-drilled holes in the necessary locations for quick & easy mounting
- » Made of .063" thick aluminum
- » **4-piece kit includes: 2 front & 2 rear plates (ENOUGH FOR BOTH SIDES)**

ABC NextGen / NextGen LMSC / NA Sportsman	11002-75133	\$20
Other Body Styles*	000-248	\$21

\*FITS THESE BODY STYLES: ABC, LMSC, S2, STRAIGHT-UP METAL, DIRT GRAND NATIONAL

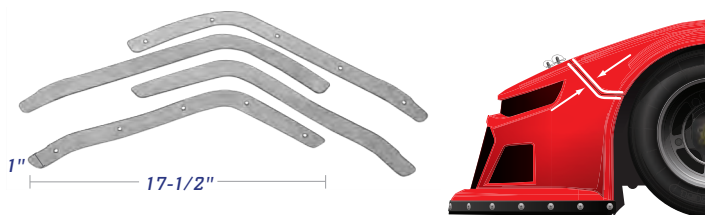

11002-75133

FOR ABC NEXTGEN, 2020 LATE MODEL STOCK CAR, NORTH AMERICAN SPORTSMAN



000-248

FOR ABC, LMSC, S2, STRAIGHT-UP METAL, DIRT GRAND NATIONAL

## GREENHOUSE-TO-QUARTER PANEL BACK-UP PLATES KIT

- » Recommended for molded plastic quarter panels
- » Reinforce the flanges where the rear greenhouse meets the quarter panels
- » Universal fit for all greenhouse-style quarter panels
- » Each back-up plate is 60 X 1-12"
- » **Kit includes: 2 pre-cut aluminum strips**

2-Piece Kit	000-278	\$7
-------------	---------	-----

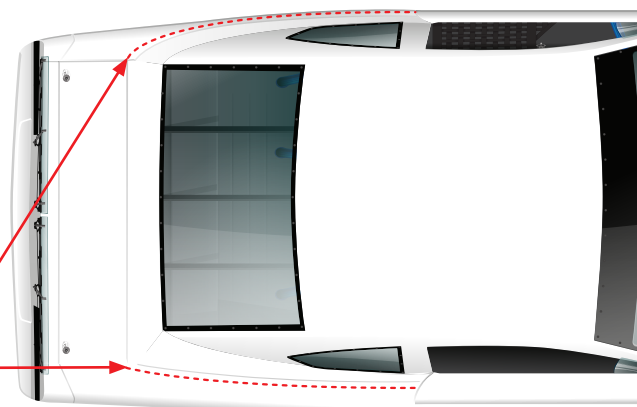

## QUARTER PANEL BODY BRACE KIT

- » Stiffens the quarter panel to maintain correct shape in an aero sensitive area
- » Highly recommend bracing for tracks 1/2-mile & longer
- » Laser-cut aluminum braces have pre-drilled holes for brace attachment
- » **Kit includes: 2 braces that mount approximately 6" back from the wheel opening & 2" up from the bottom ledge**

Brace Kit, 2-Piece	11002-75433	\$39
--------------------	-------------	------

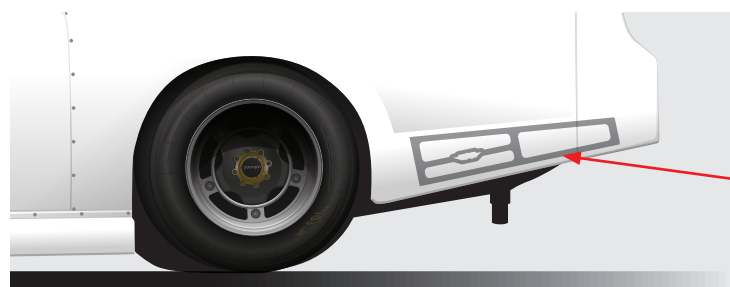

WEIGHS ONLY 1 LB

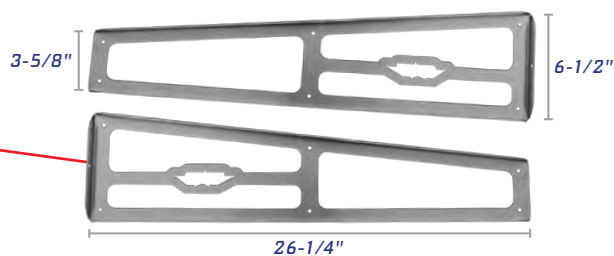

## ADJUSTABLE BODY BRACES

- » Used for spoiler & roof supports & anywhere on your car to fit templates & meet other critical dimensions
- » Easy installation with ends shaped for included screw kit or 2 rivets
- » Adjustable from 8" to 10-1/2" & features durable anodized black finish & zinc-plated hardware
- » Add extra support without adding excess weight! Package of 2 weighs only 1/2 lb
- » Can also be attached to Five Star's Chassis Clamps for quick & easy adjustable bracing on your chassis

Body Braces, 2 pack	807-3	\$35
---------------------	-------	------



EASY INSTALLATION WITH ENDS DESIGNED FOR USE WITH THE INCLUDED SCREW KIT OR 2 RIVETS



## STEEL TUBING INSTALLATION KIT

- » 55 feet of .035" hard-to-find, lightweight steel tubing for any miscellaneous needs on a race car
- » Will save at least 12 lbs over standard .065" steel tubing
- » Kit includes various shapes and sizes in 60" lengths

11-pieces: 60" lengths	819	\$79
------------------------	-----	------

Number	Shape	Diameter	Thickness	Length
1	(3) round	3/8"	.062"	60"
2	(3) square	1/2"	.035"	60"
3	(2) round	1/2"	.062"	60"
4	(3) square	3/4"	.049"	60"

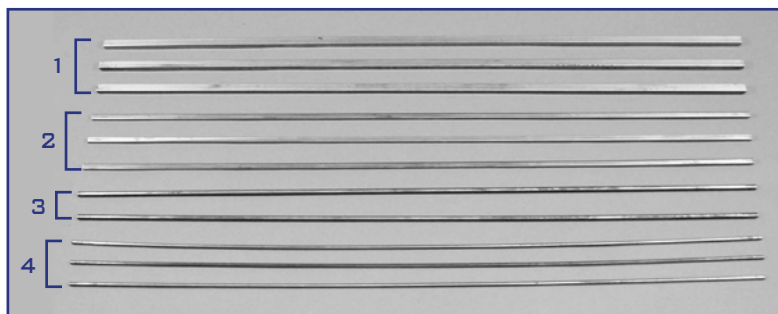

## FORMED POLYCARBONATE BODY BRACES

- » Universal brace to fit any applicable area of your car
- » Each lightweight brace weighs only 7 oz
- » Absorbs impact & allows body panels to flex upon impact & return to original position & shape
- » Kit includes: 7 clear polycarbonate braces & 14 1"x2" aluminum mounting tabs

Polycarbonate Braces	804	\$33
----------------------	-----	------

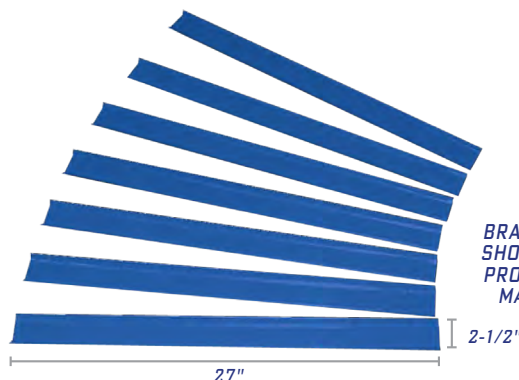

BRACES ARE SHOWN WITH PROTECTIVE MASKING



## ALUMINUM CUSTOM BRACING KIT

- » Build your own custom-length bracing as short as 6" or as long as 40"
- » Order as many tubing kits or end assemblies as needed to custom brace your car
- » Threaded end assemblies can be bolted, riveted, or attached with hose clamps
- » Complete kit includes: 1 aluminum tubing kit; 1 threaded end assembly kit; 1 left & 1 right 1/4-20 reusable tap
- » Aluminum Tubing kit includes: 2 7/16" x 3' hollow hex rods. Cut to desired length & can be tapped easily
- » Threaded End Assemblies kit includes: 2 right and 2 left threaded ends, 2 hose clamps that weighs 7.5 oz

Complete Kit	807	\$68
<b>REPLACEMENT PARTS</b>		
Tubing Kit, 2-Piece	807-1	\$29
End Assemblies, 6-Piece	807-2	\$19
Tap, left or right	807LorR	\$10

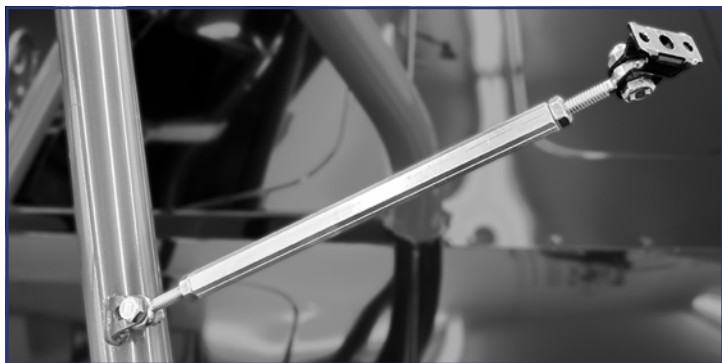

FULLY INSTALLED CUSTOM BRACE KIT



ALUMINUM TUBING | 807-1



TAP | 807L OR 807R



THREADED END ASSEMBLIES | 807-2

## STEEL BODY MOUNTING TABS

- » Designed to be welded onto chassis as a universal mount for many applications
- » Makes mounting easier by positioning bracing and mounts right where you need them
- » 25-piece kit includes enough lightweight weld-on tabs to install a complete body & weighs 5 oz
- » Each tab is 1-1/8" x 1-2"
- » Use for roof, cowl, deck lid, side bracing, and more

25-Piece Kit	807-4	\$24
--------------	-------	------



CLOSE UP OF FULLY INSTALLED TAB



# PREMIUM ADJUSTABLE BODY BRACES & ALUMINUM CHASSIS CLAMPS

CLOSE-UP OF STAMPED  
ALUMINUM END



TWO BRACES CAN ALSO BE  
MOUNTED TO A FIVE STAR  
CHASSIS CLAMP

THUMB SCREW FOR QUICK, EASY ADJUSTMENT  
TO MEET CRITICAL DIMENSIONS

TWO BRACES CAN ALSO BE  
MOUNTED TO A FIVE STAR  
CHASSIS CLAMP

INCLUDES 2 SCREWS FOR  
A QUICK, EASY INSTALL & ADJUSTMENT  
WITH 3MM ALLEN WRENCH

**NYLON: MOST FLEXIBLE - 5 oz ea.**

**ALUMINUM: LIGHTEST - 3.25 oz ea.**

**STEEL: MOST DURABLE - 8.25 oz ea.**

## PREMIUM ADJUSTABLE BODY BRACE KITS

- » Available in three options: aluminum, nylon, or steel
- » Adjustable to a maximum length of 30-1/2"
- » Stamped, black anodized aluminum mounting ends
- » Thumb screw for quick, easy length adjustments without tools
- » Kits come complete in a pack of 2

Flexible Nylon Brace Kit	10001-75951	\$33
Aluminum Brace Kit	10001-75933	\$33
Steel Brace Kit	10001-75931	\$25

## ALUMINUM CHASSIS CLAMPS

- » Universal mount fits anywhere bracing is needed
- » Eliminate the need for welding or use of hose clamps when mounting body braces
- » Threaded flange / no nut required
- » Three options to fit different roll bar tubing thickness
- » Lightweight black anodized aluminum, each clamp weighs just 1.3 oz
- » Ideal for use with Five Star's Premium Adjustable Body Braces
- » **Kits include:** 2 clamps with 1/4-20 screws

1-1/2", aluminum, 2 pack	10001-74133	\$21
1-3/4", aluminum, 2 pack	10001-74333	\$21
1-5/8", aluminum, 2 pack	10001-74533	\$21



\*\*PRICING SUBJECT TO CHANGE WITHOUT NOTICE\*\*

## POLYCARBONATE DOOR VENT WINDOWS

- » Molded vent windows give cars a proven performance gain in the wind tunnel over flat unmolded windows
- » Oversized and cut-to-fit options made of molded, mar-resistant coated clear .093" polycarbonate

Precut-to-fit, set of 2	11002-66222	\$38
<i>FITS THESE BODY STYLES: ABC NEXTGEN, NEXTGEN LMSC</i>		
Universal, set of 2	000-6202	\$39

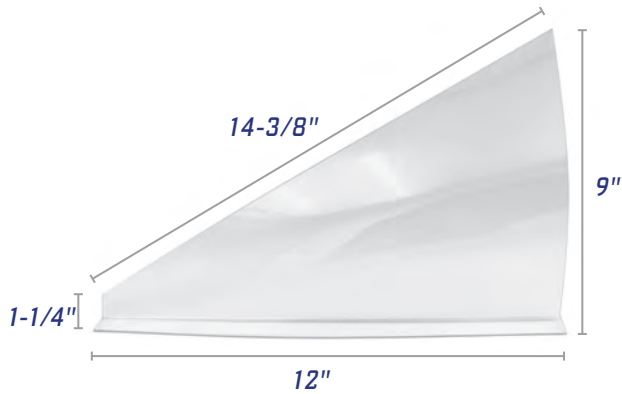

THE 11002-66222 DOOR VENT WINDOW IS CUT-TO-FIT FOR FAST & EASY INSTALLATION



THE 000-6202 DOOR VENT WINDOW IS OVERSIZED; TRIM TO FIT YOUR APPLICATION

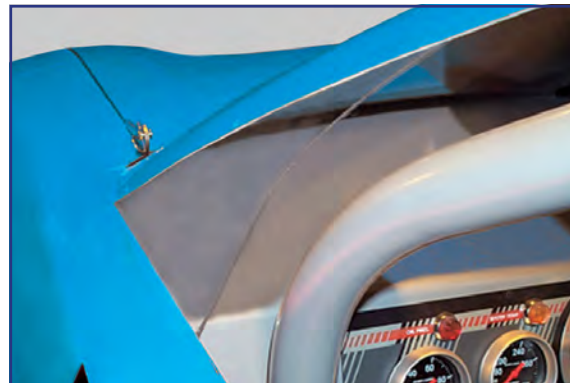

## WIDE ANGLE RACING MIRROR

- » This convex glass mirror gives you the best view of your competition, includes a bracket kit for easy installation
- » All black frame with black anodized machined aluminum brackets
- » Only weighs 19 oz

Convex Glass Mirror	00001-85020	\$49
---------------------	-------------	------



## UNIVERSAL MIRROR MOUNTING BRACKET

- » This stamped lightweight aluminum bracket allows for easy installation on any chassis
- » Satin black powder coated finish

Replacement Bracket	820-B	\$9
---------------------	-------	-----



# THE PERFECT SURFACE PREP FOR PLASTIC

## MD3 ADHESION PROMOTER

FAST DRYING & NON-SANDING



### MD3 ADHESION PROMOTER

- » Specifically engineered adhesion promoter assures proper paint bonding to our special plastic
- » Other automotive grade primers on the market may not work at all or cause severe paint flaking
- » Improves adhesion of vinyl by enhancing the bond between adhesive on the vinyl and the substrate, for a more durable, long-lasting application
- » Comes in an aerosol spray can for quick and easy application
- » A single can coats approximately 5 individual parts

MD3 Adhesion Promoter	842	\$16
-----------------------	-----	------

» A MUST USE PRODUCT BEFORE PAINTING OR APPLYING VINYL ON ANY FIVE STAR PLASTIC PART

### FIVE STAR PLASTIC WINDOW CLEANER

- » This specially formulated anti-static foaming spray contains no chemicals or abrasives that will cause damage to plastic
- » Lifts grease, grime, and wipes off fast and easy to provide a streak-free clean and clear surface finish

Window Cleaner, 19oz Can	843	\$9.95
--------------------------	-----	--------

### » FIVE STAR CLEANING TIPS!

- » ALWAYS AVOID USING ABRASIVE CLEANERS & CHEMICAL SOLVENTS THAT CAN EASILY CAUSE DAMAGE TO POLYCARBONATE WINDOWS
- » USE A MICROFIBER TOWEL FOR BEST, STREAK-FREE FINISH
- » TO PREVENT SCRATCHING AND HAZING ON YOUR WINDOWS, NEVER SCRUB WITH BRUSHES OR ABRASIVE MATERIALS



\*\*PRICING SUBJECT TO CHANGE WITHOUT NOTICE\*\*

# UNIVERSAL SHORT TRACK

## NOSES, BUMPER COVERS & COMPONENTS

VINYL NOSE GRAPHIC ID KITS FOR A REALISTIC OEM LOOK!

PRINTED ON OUTDOOR DURABLE HIGH-TACK VINYL • GLOSS LAMINATED SURFACE PROVIDES EXCELLENT PROTECTION



### CHEVROLET CAMARO

**-W -B -CB -R**

Nose	11132-41051-x	\$164	\$171
Nose ID Kit	11132-44141	\$39	\$39

### CHEVROLET CAMARO

**-W -B -CB -R**

Bumper Cover	11002-45051-x	\$155	\$160
Bumper Cover ID Kit	11132-44542	\$38	\$38



### '97 CHEVROLET CAMARO

**-W**

Nose	150-410-W	\$178
------	-----------	-------

\*NOSE GRAPHIC ID KITS NO LONGER AVAILABLE

### '97 CHEVROLET CAMARO

**-W**

Bumper Cover	150-450-W	\$160
--------------	-----------	-------

\*BUMPER COVER GRAPHIC ID KITS NO LONGER AVAILABLE



### '92 CHEVROLET CAMARO

**-W -B**

Nose (PAVEMENT)	140-410-x	\$178
Nose ID Kit	140-410-ID	\$39

### '92 CHEVROLET CAMARO

**-W -B**

Nose	145-410-x	\$178
Nose ID Kit	140-410-ID	\$39



**'81 CHEVROLET CAMARO**

**-B**

Nose, Upper 210-410U-B \$80

\*NOSE GRAPHIC ID KITS NO LONGER AVAILABLE

**'81 CHEVROLET CAMARO**

**-B**

Nose, Lower 210-410L-B \$75

\*NOSE GRAPHIC ID KITS NO LONGER AVAILABLE



**'03 CHEVROLET MONTE CARLO**

**-W -B**

Nose (FIBERGLASS SPORTSMAN)	639-410-x	\$178
Nose (SHORT TRACK)	640-410-x	\$178
Nose ID Kit	630-410-ID	\$39

**'03 CHEVROLET MONTE CARLO**

**-W -B**

Bumper Cover	630-450-x	\$160
Bumper Cover ID Kit	630-450-ID	\$38



**'94 CHEVROLET LUMINA**

**-W**

Nose 610-410-W \$178

\*NOSE GRAPHIC ID KITS NO LONGER AVAILABLE

**'94 CHEVROLET LUMINA**

**-W**

Bumper Cover 610-450-W \$160

\*BUMPER COVER GRAPHIC ID KITS NO LONGER AVAILABLE



**'03 FORD TAURUS**

**-W -B**

Nose	550-410-x	\$178
------	-----------	-------

*\*NOSE GRAPHIC ID KITS NO LONGER AVAILABLE*

**'03 FORD TAURUS**

**-W -B**

Bumper Cover	550-450-x	\$160
--------------	-----------	-------

*\*BUMPER COVER GRAPHIC ID KITS NO LONGER AVAILABLE*



**'97 FORD THUNDERBIRD**

**-W**

Nose	530-410-W	\$178
------	-----------	-------

*\*NOSE GRAPHIC ID KITS NO LONGER AVAILABLE*

**'97 FORD THUNDERBIRD**

**-W**

Bumper Cover	530-450-W	\$160
--------------	-----------	-------

*\*BUMPER COVER GRAPHIC ID KITS NO LONGER AVAILABLE*



**PONTIAC GRAND PRIX**

**-W -B**

Nose	360-410-x	\$164
Nose ID Kit	360-410-ID	\$39

**PONTIAC GRAND PRIX**

**-W -B -CB -R**

Bumper Cover	460-450-x	\$155	\$160
--------------	-----------	-------	-------

*\*BUMPER COVER GRAPHIC ID KITS NO LONGER AVAILABLE*



**'97 OLDSMOBILE CUTLASS**

**-W**

Nose	710-410-x	\$178
------	-----------	-------

*\*NOSE GRAPHIC ID KITS NO LONGER AVAILABLE*



# UNIVERSAL HEADLIGHT DECALS



H00-410S: Round, small - \$8



H01-410S: Rectangle, small - \$8



H00-411S: Round, large - \$12



H01-411S: Rectangle, large - \$12

ACHIEVE MAXIMUM VINYL ADHESION BY USING MD3 ADHESION PROMOTER. DETAILS AND ORDERING INFORMATION ON PAGE 167!



## » ALUMINUM NOSE SCREENS: PROTECT YOUR RADIATOR FROM DEBRIS PENETRATION

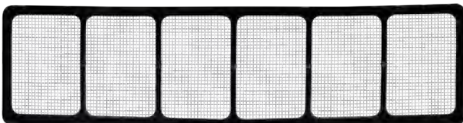

BLACK ALUMINUM FRAME

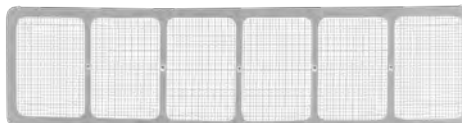

UNPAINTED

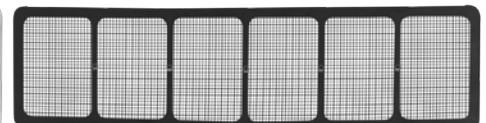

BLACK POWDER-COATED

### ALUMINUM NOSE SCREENS

- » Protects the radiator from debris penetration
- » Frame is laser cut from lightweight aluminum
- » Screen is high strength stainless steel (3/16" mesh is crimped, 1/4" is welded)
- » Available options: black aluminum frame, unpainted, or with durable satin black powder-coated finish

PN	NOSE SCREEN DESCRIPTION	WIDTH (Top)	WIDTH (Bottom)	HEIGHT	MESH	
630-4111	03 Monte Carlo, Lower	34"	34"	6"	3/16"	\$50
660-4111	Common*, Lower	27-3/4"	27-3/4"	7-1/4"	3/16"	\$50
660-4111-B	Common, Lower, Black	27-3/4"	27-3/4"	7-1/4"	3/16"	\$55
660-4112	Common, Lower	27-3/4"	27-3/4"	7-1/4"	1/4"	\$50
660-4112-B	Common, Lower, Black	27-3/4"	27-3/4"	7-1/4"	1/4"	\$55
10001-46333B	Common, Lower, Black aluminum frame	27-3/4"	27-3/4"	7-1/4"	3/16"	\$55
10001-46433B	Common, Lower, Black aluminum frame	27-3/4"	27-3/4"	7-1/4"	1/4"	\$55

\*COMMON NOSE SCREEN FITS THESE BODY STYLES: ABC NEXTGEN, ABC, NEXTGEN LATE MODEL STOCK CAR, LATE MODEL STOCK CAR, NORTH AMERICAN SPORTSMAN, STRAIGHT-UP METAL, MD3 CAMARO/MUSTANG STREET STOCK, DIRT GRAND NATIONAL

\*\*PRICING SUBJECT TO CHANGE WITHOUT NOTICE\*\*



REPRESENT AT THE TRACK WITH

# FIVE STAR MERCHANDISE



»» PERFORMANCE HOODIE

100% POLYESTER | UNISEX SIZES: S-4XL - \$40.00



»» FIVE STAR BRAND TEE

50/50 COTTON BLEND | UNISEX SIZES: S-4XL - \$20.00



» LADIES FASHION TANK

60/40 COTTON POLY BLEND | SIZES: XS-4XL - \$20.00

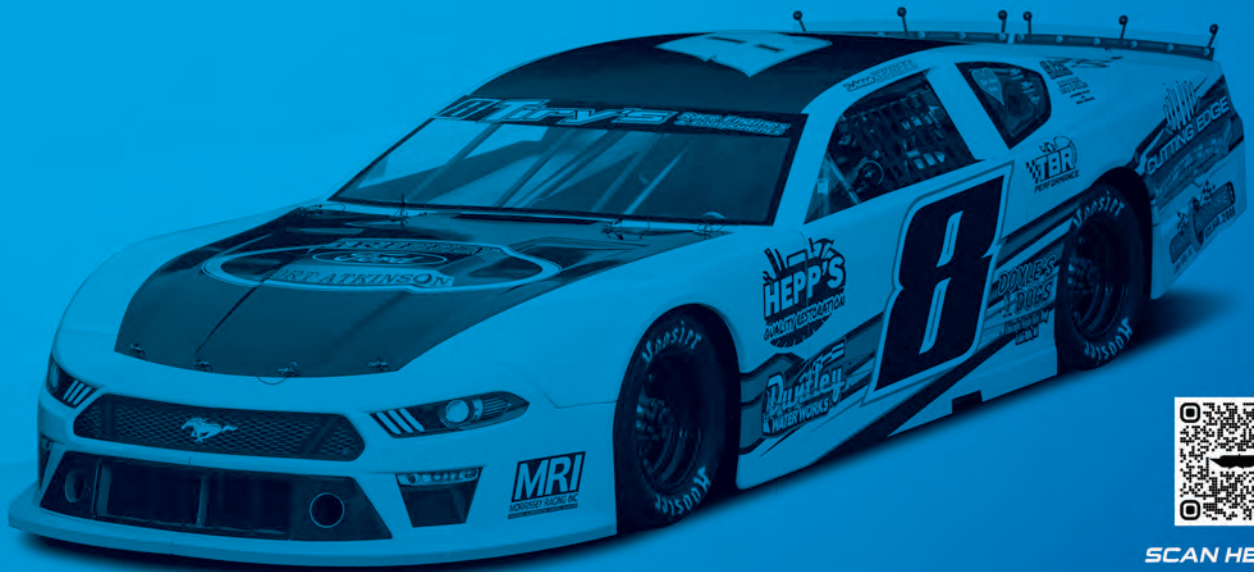

SCAN HERE TO SHOP ONLINE

#HEYNICEBODY

REPRESENT AT THE TRACK WITH

# FIVE STAR MERCHANDISE



## » FIVE STAR HATS

FLEX FIT HAT | S/M & L/XL: \$20.00

TRUCKER HAT | ONE SIZE FITS ALL: \$20.00



## » FIVE STAR KNIT BEANIES

100% ACRYLIC RIB KNIT | ONE SIZE UNISEX: GRAY OR BLACK: \$20.00



» FUN FIVE STAR EXTRAS!

CAN KOOZIE OR PREMIUM VINYL STICKER SETS: \$4.00 each

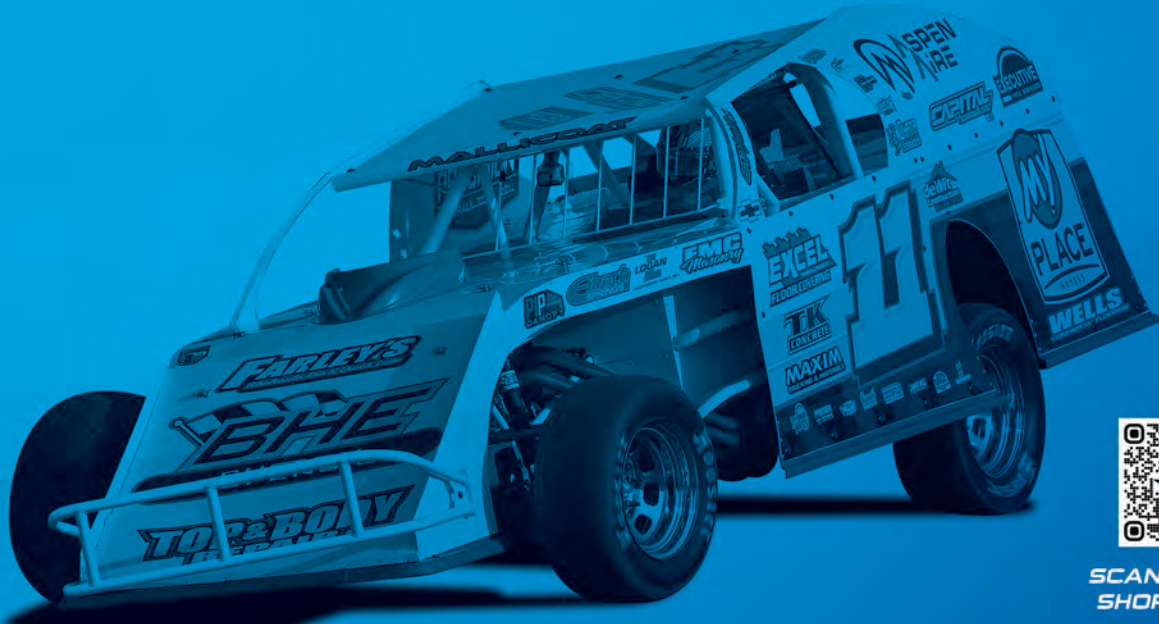

SCAN HERE TO SHOP ONLINE

#HEYNICEBODY