



2024 CATALOG

THE MOST ELITE LINE OF RACE CAR BODY PANELS, WINDOWS & COMPONENTS



#HEYNICEBODY



45+ Years of Racing History

YESTERDAY, TODAY & TOMORROW... ALWAYS THE BEST!

Five Star Race Car Bodies, a division of Five Star Fabricating, Inc., was established in the late 1970s by Carl Schultz & Fran Prestay. The company began as a side job for them in response for a need for innovative sheet metal products in the stock car racing industry. From their '79 Camaro body, the product line quickly diversified to include durable thermoformed molded plastics; lightweight fiberglass; and advanced composite race car body components. Through ongoing development we perfected the art of formed windows. Our engineers devised improvements in material composition and coatings, which also led to the development of our own superior line of polycarbonate. Our racing windows are now #1 in all motorsports. As we continue to diversify into new markets, we remain dedicated to maintaining our deep roots in auto racing, by putting our experience & expertise to work for you by providing a complete line of the greatest racing products for years to come.



» *Headquarters*

Our clean and modern 6 building campus spans over 300,000 sq feet of floorspace and is built on 44 acres in beautiful Twin Lakes, WI. This ever evolving facility features the best production equipment & manufacturing processes to achieve the highest standards.

» *'79' Camaro*

Carl & Fran's first production of the 1979 Camaro. Word of mouth and later a small ad in Stock Car Racing Magazine led to a tremendous response from racers across the country.



» *ISO Certified*

Celebrating our 11th year of ISO 9001:2015 Certification. We are proud of the huge gains that made our production processes faster and more efficient while reducing waste along the way. We strive to make our operation better every day. ISO is the American Standard for quality management systems. It is all about delivering top quality to our customers.





» *NASCAR Approved*

We manufacture advanced composite body panels for all four major NASCAR Series and are proud to be an official NASCAR Competition Partner.



» *Trade Show*

Our booth is known for being one of the first stops at the annual Performance Racing Industry Show (PRI), which is one of the largest automotive trade shows in the world. It's where we like to announce our innovative new products every year.



» *The Future*

After 4 decades, Five Star established itself as the leader across multiple motorsports markets. As we strive to stay on the cutting edge in products and service, we're excited to announce a new state of the art distribution facility being built in 2024 in Concord, North Carolina. This facility will serve as our new Dealer Service Center, currently located in Troutman.



TABLE OF CONTENTS

ADVANCED COMPOSITES.....	4
ULTRAGLASS COMPOSITES	5
HIGH-IMPACT PLASTIC	6
POLYCARBONATE WINDOWS.....	7
WHAT'S NEW.....	8-11
MERCHANDISE	12-15
ABC NEXTGEN.....	16-23
ABC GREENHOUSE.....	24-31
ABC TRADITIONAL ROOF	32-39
NEXTGEN LATE MODEL STOCK	40-47
SHORT TRACK TRUCK.....	48-53
PAVEMENT MODIFIED	54-57
OUTLAW LATE MODEL	58-61
NORTH AMERICAN SPORTSMAN.....	62-68
OLDER BODY STYLES	69
STREET STOCK.....	70-75
DIRT LATE MODEL	76-85
DIRT MODIFIED.....	86-91
DIRT GRAND NATIONAL.....	92-95
TA2 ROAD RACING.....	96-105
PRO STOCK/MOD	106-113
TOP ALCOHOL FUNNY CAR.....	114-119
RACING WINDOWS	120-123
BODY ACCESSORIES	124-147
PLASTIC NOSES & BUMPER COVERS.....	148-151
INDEX, TERMS & CONDITIONS	152-153
MEET THE TEAM & FAMILY VALUES ..	154-155

Advanced Composites

LIGHTWEIGHT, RIGID & EXTREMELY DURABLE

WHY FIVE STAR IS BETTER!

CUSTOM ENGINEERED MATERIALS

- » Incredibly strong shear & tear resistant
- » Flame retardant resins in most applications
- » Rigid no surface deflection at high speeds
- » Durable parts do not break apart

PRECISION WEIGHT CONTROL

- » Parts made with the tightest weight tolerances

FLAWLESS FINISH

- » Excellent surface finish and wrapped in a protective film



FIVE STAR'S PROPRIETARY FABRIC & RESIN BLENDS ARE MADE WITH A SUPERIOR MANUFACTURING PROCESS THAT MANY TRY TO EMULATE, BUT FAIL TO REPLICATE!

ENVIRONMENTALLY SOUND MANUFACTURING

- » All parts are manufactured in our clean EPA & OSHA compliant facility

EXCELLENT SHAPE TOLERANCE FOR REPEATABLE FIT

- » In house pattern & tool production assures great shape control



— *Ultraglass Composite* —

THE HIGH-TECH ALTERNATIVE TO OTHER FIBERGLASS COMPOSITES

FIBERGLASS PANELS REDEFINED!

UNMATCHED STRENGTH

- » Unmatched impact resistance; no other composite is stronger. Panels that deflect 300% further before breaking equals less debris on the race track and less time in the pits
- » No surface deflection at high speeds

SUPREME FINISH

- » All panels are made with a smooth inner surface
- » Most panels feature a black inner finish to eliminate painting
- » Superior surface finish & wrapped in a protective plastic film
- » Excellent shape tolerance with a repeatable fit



**UNMATCHED PERFORMANCE MANUFACTURED BY FIVE STAR:
OUR EXCLUSIVE ULTRAGLASS COMPOSITE BLEND OUT
PERFORMS ALL OTHER COMPOSITE PANELS
ON THE MARKET!**

ENVIRONMENTALLY SOUND MANUFACTURING

- » 93% reduction in harmful emissions during the manufacturing process
- » All parts are manufactured in our clean EPA & OSHA compliant facility

PRECISION WEIGHT CONTROL

- » Can be lighter than standard fiberglass composite panels
- » Ability to hold much tighter weight tolerances



TESTED TOUGH
THE TOUGHEST AND LONGEST LASTING BODIES!

High-Impact Plastics

UNSURPASSED IMPACT RESISTANCE & DURABILITY

YOU WON'T FIND A BETTER PLASTIC!

ENGINEERED TO WITHSTAND EXTREME CONDITIONS

- » High elongation provides superior flexibility & structural integrity
- » Made with our own state of the art proprietary blend of plastic material
- » Some plastics are fire resistant & pass industry testing standards
- » We match the plastic materials for specific applications

SUPERIOR SHAPE CONTROL

- » Parts are formed using advanced computer automated thermoforming machines with temperature controlled cast aluminum tooling
- » Shaped with even thickness & consistent part weight
- » Consistent shape tolerance allows for easy replacement
- » We match the plastic materials for specific applications
- » Durable parts do not break apart



THIS FEATURED PLASTIC IS USED IN THE MD3 BRAND. THE UNDISPUTED BEST BODY PANELS IN ALL OF DIRT RACING!



EXCELLENT SHAPE TOLERANCE FOR REPEATABLE FIT

- » In house forming assures great shape control

THE MD3 ADHESION PROMOTER WORKS BEST

- » Our MD3 brand Adhesion Promoter is specifically engineered for the special plastic materials we use.



— Polycarbonate Windows —

THE #1 CHOICE BY TOP RACERS & TEAMS WORLDWIDE

SUPERIOR OPTICS & SAFETY!

BETTER THAN GLASS

- » Up to 50% weight savings compared to glass
- » Can be formed into multiple shapes or styles
- » Multiple thickness & tint options available
- » Enhances driver safety

WE CAN SHAPE FORM ANY WINDOW

- » We can meet all of your polycarbonate and acrylic needs, not just racing windows
- » We can form windows from factory glass for limited quantity orders
- » We offer in-house design & mold building for any windows you need
- » CNC pattern cutting



**THE #1 LINE OF WINDOWS USED IN ALL OF MOTORSPORTS
BECAUSE OF IT'S SUPERIOR OPTIC CLARITY
AND UNMATCHED SAFETY!**

PRECISION FIT GUARANTEED

- » Proprietary forming process ensures unrivaled optical clarity and accurate shape control
- » CNC routing ensures a perfect drop in fit, everytime

SUPERIOR OPTICAL CLARITY & DURABILITY

- » We only use the highest Optical Grade Polycarbonate developed exclusively by, and only from Five Star
- » Windows coated with our World-Renowned, high-tech coating process for unsurpassed durability & improved product life.
- » The highest abrasion, chemical & UV resistance
- » Windows printed with a durable black ink boarder



INTRODUCING NEW PRODUCTS FOR 2024

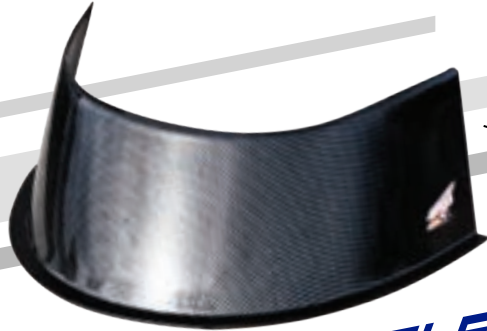

>> 6" TALL AIR DEFLECTOR
MAXIMUM PROTECTION FOR YOUR AIR FILTER!
FOR DETAILED PRICING INFO GO TO PAGE: 83



>> MD3 PLASTIC MODIFIED NOSE KIT
UPGRADE FROM ALUMINUM TO EXTREMELY DURABLE PLASTIC!
FOR DETAILED PRICING INFO GO TO PAGE: 89



>> MD3 PLASTIC RIGHT DOOR & QUARTER
SPEND MORE TIME RACING & LESS TIME REPLACING!
FOR DETAILED PRICING INFO GO TO PAGE: 89



RIGHT QUARTER PANEL



RIGHT DOOR

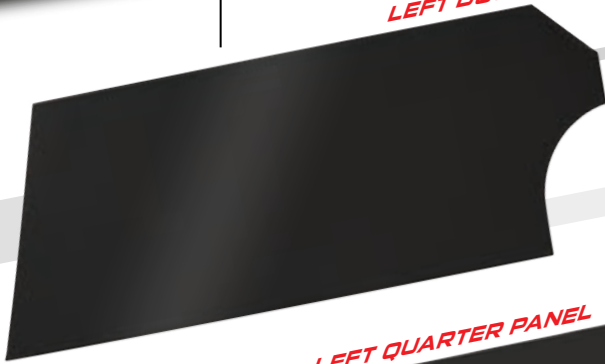

LEFT DOOR

LEFT QUARTER PANEL

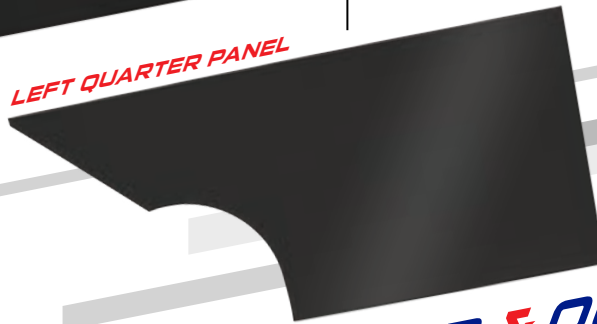

>> MD3 PLASTIC LEFT DOOR & QUARTER
SPEND MORE TIME RACING & LESS TIME REPLACING!
FOR DETAILED PRICING INFO GO TO PAGE: 89

INTRODUCING NEW PRODUCTS FOR 2024



>> MD3 MOLDED PLASTIC RIGHT SIDE SPOILER KIT
UPGRADE FROM ALUMINUM TO EXTREMELY DURABLE PLASTIC!
FOR DETAILED PRICING INFO GO TO PAGE: 81



>> 18" WIDE HOOD SCOOP & DEFLECTOR
MAXIMUM PROTECTION FOR YOUR AIR FILTER!
FOR DETAILED PRICING INFO GO TO PAGE: 80



>> OUTLAW LATE MODEL ROOF
AGGRESSIVE AERODYNAMIC STYLING WITH LIGHTWEIGHT STRENGTH!
FOR DETAILED PRICING INFO GO TO PAGES: 60-61



>> OUTLAW LATE MODEL NOSE
WINNING TOP RACES IN 2023 & BEYOND!
FOR DETAILED PRICING INFO GO TO PAGE: 60

REPRESENT WITH **FIVE STAR** MERCHANDISE



» **PERFORMANCE HOODIE**

FOR THOSE COOLER NIGHTS - MADE OF 100% POLYESTER
UNISEX SIZES: S-4XLT - \$40.00



» "FS" BRAND TEE

FIVE STAR FLAGSHIP BRAND TEE - MADE OF A 50/50 COTTON BLEND
UNISEX SIZES: S-4XLT - \$20.00

FIVE STAR



MERCH

REPRESENT WITH FIVE STAR MERCHANDISE



NEW!

» LADIES FASHION TANK

FIVE STAR FASHION - 60/40 RING SPUN COMBED COTTON/POLY
LADIES SIZES: XS-4XL - \$20.00



» "FS" KNIT BEANIE

STRETCHY KNIT FABRIC COMFORT - 100% ACRYLIC RIB KNIT
ONE SIZE UNISEX: GRAY or BLACK - \$20.00



» **FIVE STAR HATS**

THE FIVE STAR FLEX-FIT HAT or THE MESH BACK TRUCKER HAT
UNISEX SIZES: S-XXL - **\$20.00**



» **FUN EXTRAS!**

#HEY NICE BODY CAN KOOZIE or PREMIUM VINYL DECAL SETS
KOOZIE or MEDIUM DECAL SET or LARGE DECAL SET - **\$4 Each**



FIVE STAR



MERCH



ABC NEXTGEN

THE MOST ADVANCED BODY ON THE MARKET

The ABC NextGen Body is the pinnacle of high-performance engineering, setting a new standard for durability and aerodynamics in the late model racing world. This body is hassle free and easy for any racer to install.





- » Enhanced safety with the use of flame-retardant resin in the Advanced Lightweight Composite greenhouse
- » Minimal trimming required
- » Wider greenhouse increases driver access & accommodates wider roll cages
- » Two-piece greenhouse includes a built-in cowl and deck lid filler
- » Additional engine clearance with more fender clearance for suspension travel
- » Exceptional aero balance achieved and validated through extensive wind tunnel and on track testing
- » All panels have consistent & repeatable fit for effortless installation & replacement
- » Panels have mounting flanges & locating tabs
- » Common body has 3 nose options for brand identity
- » Available in 4 colors



ABC NEXTGEN

BODY PACKAGES & OPTIONS

HOW TO ORDER YOUR BODY IN 3 QUICK & EASY STEPS

» 1. SELECT BODY PACKAGE » 2. SELECT PANEL COLOR » 3. SELECT NOSE MAKE

RE-SKIN BODY PACKAGE		-W -B	-CB -R
Bumper Cover, Rear, high-impact plastic	11002-45051-x	\$155	\$160
Door, aluminum, left	11002-21033-xL	\$112	\$112
Door, aluminum, right	11002-21033-xR	\$112	\$112
Fender, high-impact plastic, left	11002-23051-xL	\$150	\$154
Fender, high-impact plastic, right	11002-23051-xR	\$150	\$154
Nose, high-impact plastic (SPECIFY MAKE: CAMARO-11132; MUSTANG-11322; CAMRY-11712)	11xx2-41051-x	\$164	\$171
Quarter Panel, high-impact plastic, left	11002-27351-xL	\$134	\$142
Quarter Panel, high-impact plastic, right	11002-27351-xR	\$134	\$142
Rocker Panel, fits either side, high-impact plastic (2 REQUIRED) SPECIFY COLOR: -W -B -CB -R -Y	000-5501P-x	\$33	\$38
Rocker Panel, fits either side, high-impact plastic (ENTERED TWICE TO SHOW PACKAGE PRICE)	000-5501P-x	\$33	\$38
RE-SKIN BODY PACKAGE PRICE	11002-10000-x	\$1,177	\$1,223

COMPLETE BODY PACKAGE (RE-SKIN COMPONENTS PLUS ITEMS BELOW)		-W -B	-CB -R
Cowl Air Insert, Ultraglass composite	661-5100A-x	\$68	\$73
Deck Lid Hold-Down Strip, aluminum	XM 000-310H-x	\$10	\$10
Deck Lid, aluminum	661-310A-x	\$76	\$76
Greenhouse, Front with built-in cowl, composite	11002-51311-x	\$400	\$464
Greenhouse, Rear, composite	11002-51511-x	\$480	\$552
Hood, composite	11002-33011-x	\$320	\$360
*Spoiler, Complete, 4pc, 1/4" poly blades, unpainted brackets, 6-1/2" x 64-1/2", 70°	11002-47387	\$139	\$139
Windshield, mar-resistant coated, 1/8"	11002-63253	\$357	\$357
Windows, Quarter, mar-resistant coated, 0.093", left	11002-65153-L	\$55	\$55
Windows, Quarter, mar-resistant coated, 0.093", right	11002-65153-R	\$55	\$55
Window, Rear, uncoated, 0.093"	11002-61151	\$201	\$201
COMPLETE BODY PACKAGE PRICE	11002-10600-x	\$3,328	\$3,555

*ALL WINDOWS ARE PRECUT TO FIT, BEVELED & DRILLED, WITH BLACK-OUT BORDER UNLESS OTHERWISE SPECIFIED.

TO ENHANCE YOUR BODY PACKAGE, CHOOSE FROM THE OPTIONS BELOW:

BODY PACKAGE OPTIONS & UPGRADES (ADD OR SUBTRACT TO PACKAGE PRICE ABOVE FOR TOTAL)					-W -B	+/- PKG PRICE	-CB -R	+/- PKG PRICE	
Door, with fender mounting recess, aluminum, left / right (BODY PKG PRICE IS X2)					11002-21233-xLorR	\$112	\$0	\$112	\$0
Door, for longer wheelbase, aluminum, left / right (SPECIAL ORDER) (BODY PKG PRICE IS X2)					11002-21133-xLorR	\$112	\$0	\$112	\$0
Fender, Ultraglass composite, left / right (BODY PKG PRICE IS X2)					11002-23013-xLorR	\$285	+\$135	\$319	+\$165
Greenhouse, Front, advanced lightweight composite					11002-51312-x	\$955	+\$555	\$955	+\$491
Greenhouse, Rear, advanced lightweight composite					11002-51512-x	\$995	+\$515	\$995	+\$443
Quarter Panel, Ultraglass composite, left / right (BODY PKG PRICE IS X2)					11002-27313-xLorR	\$314	+\$180	\$370	+\$228
Rocker Panels, fits either side, aluminum (BODY PKG PRICE IS X2)					000-5501A-x	\$39	+\$6	\$39	+\$1
Hood, oversized, advanced lightweight composite					11002-33011L-x	\$619	+\$299	\$619	+\$259
Window, Rear, mar-resistant coated, .093"					11002-61153	\$347	+\$146	\$347	+\$146
Spoilers: 60" wide	5" (90°)	5" (70°)	6-1/2" (90°)	6-1/2" (70°)					
Complete, aluminum	11002-47359	11002-47357	11002-47369	11002-47367	\$129	-\$10	\$129	-\$10	
Complete, aluminum, black	11002-47359-B	11002-47357-B	11002-47369-B	11002-47367-B	\$139	\$0	\$139	\$0	
Spoilers: 64-1/2" wide	5" (90°)	5" (70°)	6-1/2" (90°)	6-1/2" (70°)					
Complete, aluminum	N/A	N/A	11002-47389	11002-47387	\$139	\$0	\$139	\$0	
Complete, aluminum, black	N/A	N/A	11002-47389-B	11002-47387-B	\$149	+\$10	\$149	+\$10	

*70° SPOILER PREFERRED FOR OPTIMUM AERO PERFORMANCE

ABC NEXTGEN

BODY MOUNTING KIT

» EVERYTHING YOU NEED FOR THAT CLEAN & PROFESSIONAL INSTALL!

COMPLETE BODY MOUNTING KIT SAVE \$\$ WHEN PURCHASING COMPLETE KIT VERSUS INDIVIDUAL COMPONENTS!

Adjustable Body Braces (X3 @ \$35 EACH)	807-3	\$105
Aluminum Nose Side Braces, pair	11002-75333	\$14
Door Vent Windows, pair	11002-66222	\$33
Front Bumper Mounting Kit	10001-72721	\$132
Front Bumper, 1-3/4", .065" steel	11002-71182	\$48
Graphics, Nose ID Kit (SPECIFY MAKE BELOW)	11xx2-44141	\$37
Graphics, Bumper Cover ID Kit (SPECIFY MAKE BELOW)	xxxx2-44541	\$36
Hood Pin Bracket, 3/4" steel (4 PINS REQUIRED)	11002-34331	\$35
Hood Pin Kit, 3/8" pins (X2 @ \$15EA) SPECIFY COLOR: -B -CB -R	10001-34033-x	\$30
Nose Screen, stainless, 3/16"	660-4111	\$50
Rear Bumper Mounting Kit	802-25	\$49
Rear Bumper, 1-3/4", .065" steel	11002-71682	\$48
Rear Deck Mounting Kit	660-450-RDK	\$87
Rear Window Brace Kit (3PC)	11002-76133	\$76
Right Side Door Support	11002-75533	\$30
Universal Body Mounting Kit, plastic	00001-72651	\$29
Wear Strips, plastic SPECIFY COLOR: -W -B -CB -OR -R -Y -FG -FO -FR -FY	11002-41551-x	\$35
Window Installation Kit	805	\$23
Windshield Brace Kit (3PC)	11002-76333	\$76
COMPLETE KIT PRICE WITH 10% DISCOUNT 11002-72520		\$875.70

BODY MOUNTING KIT OPTIONS & UPGRADES (ADD OR SUBTRACT GREEN \$ TO PACKAGE PRICE ABOVE FOR TOTAL)

Front Bumper, 1-3/4" round, .095" steel	11002-71185	\$48	\$0	Nose Screen, black, 1/4"	660-4112-B	\$55	+\$5
Front Bumper, 1-3/4" round, .095" steel W/ 12" EXT.	11002-71188	\$56	+\$8	Nose Screen, black, 3/16"	660-4111-B	\$55	+\$5
Hood Pin Bracket, 3/4" aluminum	11002-34333	\$66	+\$31	Nose Screen, black aluminum frame, 3/16"	10001-46333B	\$55	+\$5
Hood Pin Kit, 1/2" pins (5PC)	803	\$38	+\$8	Nose Screen, black aluminum frame, 1/4"	10001-46433B	\$55	+\$5
Nose Screen, 1/4"	660-4112	\$50	\$0	Universal Body Mounting Kit, aluminum	000-400k	\$49	+\$20

VINYL NOSE & BUMPER COVER GRAPHIC ID KITS FOR A REALISTIC OEM LOOK!

PRINTED ON OUTDOOR DURABLE HIGH-TACK VINYL • GLOSSY LAMINATED SURFACE PROVIDES EXCELLENT PROTECTION



CHEVROLET CAMARO

Nose ID Kit	11132-44141	\$37
Bumper Cover ID Kit	11132-44542	\$36



FORD MUSTANG

Nose ID Kit	11322-44141	\$37
Bumper Cover ID Kit	11322-44541	\$36



TOYOTA CAMRY

Nose ID Kit	11712-44141	\$37
Bumper Cover ID Kit	11712-44541	\$36

» GO TO PAGES 124-147 TO SEE ALL ACCESSORIES FOR THIS BODY

PRICING SUBJECT TO CHANGE WITHOUT NOTICE

ABC NEXTGEN

FEATURED BODY ACCESSORIES



PREMIUM AVEX STYLE RIVETS:

- » Five Star Premium Rivets are known as the best quality on the market
- » Super-tight grip and won't spin out while drilling!
- » Grip range of up to 3/16" for 1/8" rivets and up to 1/2" for 3/16" rivets
- » For more details & ordering info page 126



COWL INDUCTION COLD AIR BOXES:

- » 4 barrel and 2 barrel offset options available
- » Flow bench tested for peak air flow
- » For more details & ordering info page 134



ALUMINUM LOWER NOSE SUPPORT BRACKET

- » Mounts under the lower valance to maintain strength and structural integrity for the nose under high speeds
- » Choose from a lightweight aluminum or steel bracket
- » For more details & ordering info page 130

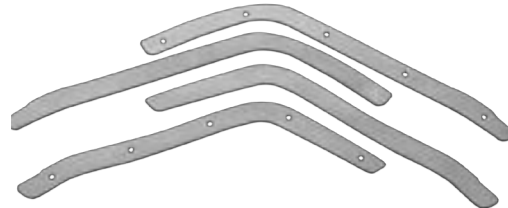

FENDER-TO-NOSE BACK UP PLATES:

- » 4 Piece Kit Includes: 2 Fronts & 2 Rear Plates (Enough for both sides)
- » Pre-drilled holes in the necessary locations for quick & easy mounting
- » For more details & ordering info page 142

» GO TO PAGES 122-147 TO SEE ALL ACCESSORIES FOR THIS BODY STYLE

FIVE STAR BODIES ARE DESIGNED TO MAINTAIN PRECISE FIT WITH OPTIMIZED AERODYNAMICS!

WIDTHS

A	B	C
79 1/2" MAX"	68"	67"
Body Width: Measured at wheel wells	Door to Door Width: Measured at A-posts & inside edge of doors, measured through car	Door to Door Width: Measured at B-posts & inside edge of doors, measured through car

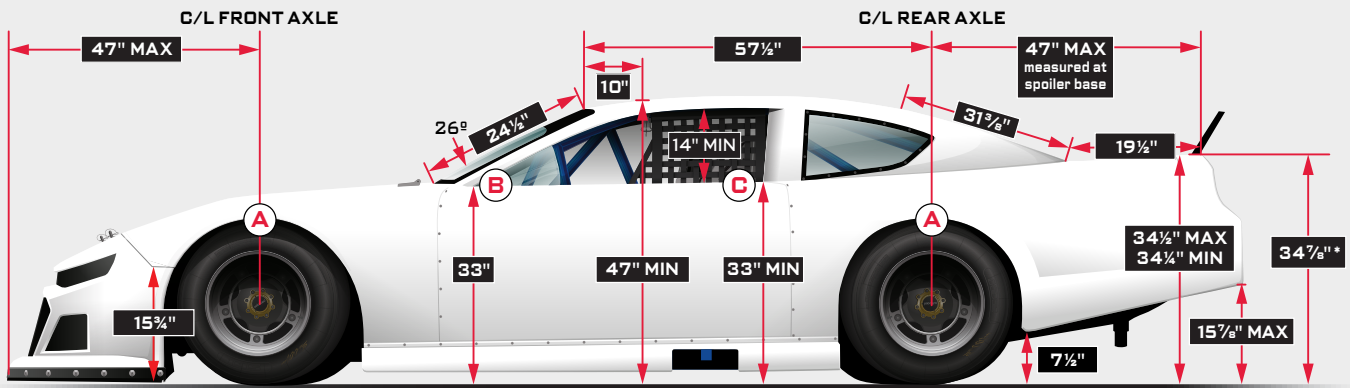

NOTES:

1. If the Roof Height (10" back from windshield), Door Height (rear), Quarter Panel, or Bumper Cover Height dimensions are higher than the stated minimum dimensions, all four must increase by the same amount.

2. Must fit centerline template within allowable tolerance. *Measured at the seam of bumper cover at deck lid intersection, +/- 1/4"

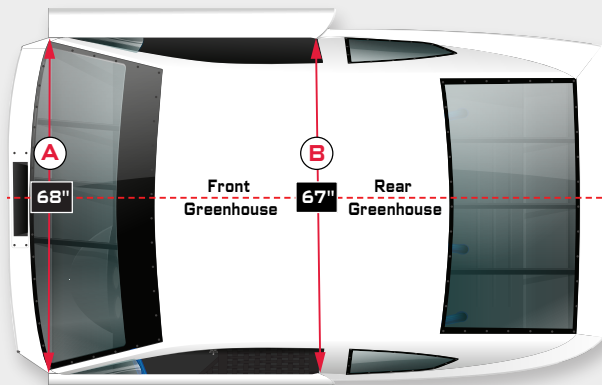

CHASSIS	ROOF HEIGHT	TREAD WIDTH	WHEELBASE
Offset/ Straight Rail	47"	66" MAX	101-106"

BODY PANEL



DIMENSIONS

» FOR INDIVIDUAL BODY PANEL DIMENSIONS, VISIT FIVESTARBODIES.COM

ABC NEXTGEN

BODY MOUNTING FIXTURES

MOUNT YOUR BODY FAST & EASY TO MAXIMIZE PERFORMANCE & HELP PASS TECH!

It is the responsibility of all competitors to present a car that fits the templates within allowable tolerances and meets all dimensions as inspected by the "Referee." Be sure to download a free copy of the Official ABC Rulebook for body styles, panels, spoilers, windows, overhangs, roof height, proper placement of templates, and more!



THE OFFICIAL REFEREE 2.0

- » Used by tracks and associations throughout North America for body tech inspection
- » Measure the front overhang of the nose, tread width, roof, door, and deck height, rear overhang, wheelbase, and engine setback
- » Adjustable laser option for accurate measurements of front overhang and engine setback
- » Magnetic, tinted polycarbonate wheel plates for better attachment to wheels
- » Includes Tech Inspector's checklist
- » **NOT NECESSARY FOR MOUNTING A BODY.** A body can easily be installed within specs by using the body dimensions sheets & templates

Referee 2.0	TT-200-00	\$1,975
Wheel Locator, w/magnets (SET OF 4) (SOLD SEPARATELY)	TT-200-WL	\$98
Laser Measurement Assembly (SOLD SEPARATELY)	TT-200-LB	\$150

VISIT OUR YOUTUBE PAGE FOR A TECH VIDEO DEMONSTRATING USE OF THE OFFICIAL REFEREE 2.0



ROOF LOCATING FIXTURE

- » THE FAST & EASY WAY TO MOUNT YOUR COMPLETE BODY WITHOUT THE CHASSIS UNDERNEATH
- » This time-saving device has adjustable quarter panel arms and makes locating the roof on your chassis a simple process
- » Allows exact fit for wheel opening locations, body dimensions, and inspection templates to fit series specs
- » Pre-fits from the cowl to the bumper cover, then can be lifted easily on top of the chassis for final fit
- » Comes in a black powder-coat finish and includes roof brackets, door height blocks and assembly instructions

Roof Locating Fixture (INCLUDES ROOF BRACKETS & DOOR HEIGHT BLOCKS)	809P	\$875
Replacement Roof Brackets	11002-72231	\$71
Replacement Door Height Blocks, 6" tall	11002-72331	\$38

ABC NEXTGEN

TOOLS & TEMPLATES

ABC
LMSC
TRUCK
PAV MODIFIED
OUTLAW LATE MODEL
SPORTSMAN
STREET STOCK
M03 LATE MODEL
M03 MODIFIED
DIRT GRAND NATL
T22
PRO STOCK/MOD
FUNNY CAR
WINDOWS
ACCESSORIES



ABC NEXT GEN TEMPLATES ENSURE A CORRECT FIT FOR OPTIMUM AERODYNAMICS

- » Complete template set ensures body is installed correctly
- » Complete sets include: Body Centerline, Nose Centerline, Nose Side-to-Side, Fenders, Extended Front Roof Side-to-Side, Extended Rear Roof Side-to-Side, and Rear Deck Side-to-Side
- » Common templates can check all models
- » Master sets available with templates for all models

Template, Complete Set, wood, Chevrolet Camaro	11132-82091	\$345
Template, Complete Set, wood, Toyota Camry	11712-82091	\$345
Template, Complete Set, wood, Ford Mustang	11322-82091	\$345
Template, Master Set, wood, all models	11002-82091	\$501
Template, Nose Side-to-Side, wood, Common	11002-82491	\$58
NEW! TEMPLATES: ENHANCED SHAPE CONTROL FOR 2024		
Template, Roof, Front, Side-to-Side, extended, wood, Common	11003-82591	\$49
Template, Roof, Rear, Side-to-Side, extended, wood, Common	11003-82691	\$49
Template, Rear Deck Lid, wood, Common	11003-83591	\$49

RULEBOOK



QR CODE

» **DOWNLOAD OFFICIAL ABC RULEBOOK @ FIVESTARBODIES.COM**



» **FOR MORE BODY MOUNTING TOOLS, GO TO PAGES 124-147**

PRICING SUBJECT TO CHANGE WITHOUT NOTICE



ABC GREENHOUSE STYLE BODY

***TWO-PIECE ROOF CONFIGURATION ALLOWS FOR
PRECISION FIT & ADDED DURABILITY***

The two-piece roof configuration features mounting flanges with built-in locating tabs to speed up installation. This body comes standard with high-impact plastic quarter panels that are durable & easier to replace.





- » Streamlined greenhouse body design for simplified installation, reducing time and cost associated with quarter panel replacement compared to traditional styles
- » Designed to fit templates perfectly
- » Consistent & repeatable fit for all replacement panels
- » Rear window installation made easy and hassle-free
- » Common body has 4 different options
- » Available in 4 colors



ABC GREENHOUSE STYLE

BODY PANELS & OPTIONS

HOW TO ORDER YOUR BODY IN 3 QUICK & EASY STEPS

» 1. SELECT BODY PACKAGE » 2. SELECT PANEL COLOR » 3. SELECT NOSE MAKE

RE-SKIN BODY PACKAGE		-W	-B	-CB	-R
Bumper Cover, Rear, high-impact plastic	460-450-x	\$155		\$160	
Door, aluminum, left	661-21A-xL	\$112		\$112	
Door, aluminum, right	661-21A-xR	\$112		\$112	
Fender, 10" tires, high-impact plastic, left	660-24-xL	\$150		\$154	
Fender, 10" tires, high-impact plastic, right	660-24-xR	\$150		\$154	
Nose, high-impact plastic (SPECIFY MAKE: CHEVY SS-660; FUSION-570; CAMRY-720; CHARGER-470 IS B/W ONLY)	xxx-410-x	\$164		\$171	
Quarter Panel, high-impact plastic, left	670-27-xL	\$134		N/A	
Quarter Panel, high-impact plastic, right	670-27-xR	\$134		N/A	
Rocker Panel, fits either side, high-impact plastic (2 REQUIRED) SPECIFY COLOR: -W -B -CB -R -Y	000-5501P-x	\$33		\$38	
Rocker Panel, fits either side, high-impact plastic (ENTERED TWICE TO SHOW PACKAGE PRICE)	000-5501P-x	\$33		\$38	
RE-SKIN BODY PACKAGE PRICE	593-100-x	\$1,177		\$1,223	

COMPLETE BODY PACKAGE (RE-SKIN COMPONENTS PLUS ITEMS BELOW)

Cowl Panel Kit (INCLUDES COWL AIR INSERT AND TABS), ULTRAGLASS COMPOSITE WITH FIRE RETARDANT RESIN	671-5100-x	\$249		\$299	
Deck Lid Hold-Down Strip, aluminum	XM 000-310H-x	\$10		\$10	
Deck Lid, aluminum	661-310A-x	\$76		\$76	
Greenhouse, Front, composite	671-5112-x	\$298		\$324	
Greenhouse, Rear, composite	671-5102-x	\$442		\$510	
Hood, flat, composite	670-3301-x	\$320		\$360	
Spoiler, Complete, 4pc, unpainted aluminum blades & brackets, 6-1/2" x 60", 70°	661-6737	\$129		\$129	
Window, Quarter, mar-resistant coated, 0.093", left	460-6515BL	\$55		\$55	
Window, Quarter, mar-resistant coated, 0.093", right	460-6515BR	\$55		\$55	
Window, Rear, uncoated, 0.093"	574-6111-3B	\$201		\$201	
Windshield, mar-resistant coated, 1/8"	564-6325-3B	\$357		\$357	
COMPLETE BODY PACKAGE PRICE	593-142-x	\$3,369		\$3,599	

*ALL WINDOWS ARE PRECUT TO FIT, BEVELED & DRILLED, WITH BLACK-OUT BORDER UNLESS OTHERWISE SPECIFIED.

TO ENHANCE YOUR BODY PACKAGE, CHOOSE FROM THE OPTIONS BELOW:

BODY PACKAGE OPTIONS & UPGRADES (ADD OR SUBTRACT TO PACKAGE PRICE ABOVE FOR TOTAL)		-W	-B	+/- PKG PRICE	-CB	-R	+/- PKG PRICE
Door, for longer wheelbase, aluminum, left / right (SPECIAL ORDER) (BODY PKG PRICE IS X2)	661-211A-xLorR	\$112	\$0		\$112	\$0	
Fender, for 10" tires, Ultraglass composite, left / right (BODY PKG PRICE IS X2)	663-240-xLorR	\$289	+\$139		\$329	+\$175	
Fender, for 8" tires, composite, left / right (AVAILABLE ONLY IN BLACK OR WHITE) (BODY PKG PRICE IS X2)	663-230-xLorR	\$169	+\$19		N/A	N/A	
Fender, 8" tires ACT SERIES, high-impact plastic, left / right	660-23-xLorR	\$150	\$0		N/A	N/A	
Greenhouse, Front, advanced lightweight composite	671-5112L-x	\$524	+\$226		\$524	+\$200	
Greenhouse, Rear, advanced lightweight composite	671-5102L-x	\$944	+\$502		\$944	+\$434	
Hood, flat, advanced lightweight composite	670-3301L-x	\$585	+\$265		\$585	+\$225	
Hood, scooped, composite (AVAILABLE ONLY IN BLACK OR WHITE) NOT ABC APPROVED	660-3303-x	\$320	\$0		N/A	N/A	
Quarter Panel, Ultraglass composite, left / right (BODY PKG PRICE IS X2)	673-270-xLorR	\$314	+\$180		\$370	+\$228	
Rocker Panels, fits either side, aluminum (BODY PKG PRICE IS X2)	000-5501A-x	\$39	+\$6		\$39	\$1	
Cowl Panel Air Deflector, Ultraglass composite (AVAILABLE ONLY IN BLACK)	000-5200A	\$55	+\$55		N/A	N/A	
Windshield, mar-resistant coated, 0.093"	574-6115-3B	\$315	+\$114		\$315	+\$114	
Window, Rear, mar-resistant coated, 3/16" (FOR ENHANCED DRIVER SAFETY)	564-6335-3B	\$397	+\$40		\$397	+\$40	
Spoilers: 60" wide	5" (90°)	5" (70°)	5" (55°)	6-1/2" (90°)	6-1/2" (70°)	6-1/2" (55°)	
Complete, aluminum	661-6749	661-6747	661-6745	661-6739	661-6737	661-6735	\$129 \$0 \$129 \$0
Complete, aluminum, black	661-6749-B	661-6747-B	661-6745-B	661-6739-B	661-6737-B	661-6735-B	\$139 \$10 \$139 \$10

ABC GREENHOUSE STYLE

BODY MOUNTING KIT

» EVERYTHING YOU NEED FOR THAT CLEAN & PROFESSIONAL INSTALL!

COMPLETE BODY MOUNTING KIT SAVE \$\$ WHEN PURCHASING COMPLETE KIT VERSUS INDIVIDUAL COMPONENTS!

Adjustable Body Braces (X3 @ \$35EA)	807-3	\$105
Aluminum Nose Side Braces, pair	000-500	\$39
Door Vent Windows, pair	000-6202	\$35
Front Bumper Mounting Kit	10001-72721	\$132
Front Bumper, 1-3/4", .065" steel	660-7103	\$48
Graphics, Nose ID Kit (SPECIFY MAKE BELOW)	xx0-410-ID	\$37
Graphics, Bumper Cover ID Kit (SPECIFY MAKE BELOW)	xx0-450-ID	\$36
Hood Pin Bracket, 1/2" steel (5 PINS REQUIRED; SPECIFY MAKE PAGE 129)	xx0-410-HPB	\$35
Hood Pin Kit, 3/8" pins (X3 @ \$15EA) -B -CB -R	10001-34033-x	\$45
Nose Screen, stainless, 3/16"	660-4111	\$50
Rear Bumper Mounting Kit	802-25	\$49
Rear Bumper, 1-3/4", .065" steel	570-7503	\$48
Rear Deck Mounting Kit	660-450-RDK	\$87
Rear Window Brace Kit (3PC)	674-6101	\$76
Right Side Door Support	11002-75533	\$30
Universal Body Mounting Kit, plastic	00001-72651	\$29
Wear Strips, plastic SPECIFY COLOR: -W -B -CB -OR -R -Y -FG -FO -FR -FY	000-400-x	\$35
Window Installation Kit	805	\$23
Windshield Brace Kit (3PC)	564-6301	\$76
COMPLETE KIT PRICE WITH 10% DISCOUNT	800-1D	\$913.50

BODY MOUNTING KIT OPTIONS & UPGRADES (ADD OR SUBTRACT GREEN \$ TO PACKAGE PRICE ABOVE FOR TOTAL)

Front Bumper, 1-3/4" round, .095" steel	660-7103B	\$48	\$0	Nose Screen, 1/4" spacing	660-4112	\$50	\$0
Front Bumper, 1-3/4" round, .095" steel W/12" EXT	660-7103C	\$56	+\$8	Nose Screen, black, 1/4" spacing	660-4112-B	\$55	+\$5
Hood Pin Bracket, 3/4" aluminum (SPECIFY MAKE PG 129)	xx0-411A-HPB	\$66	+\$31	Nose Screen, black, 3/16" spacing	660-4111-B	\$55	+\$5
Hood Pin Bracket, 3/4" steel (SPECIFY MAKE PG 129)	xx0-411-HPB	\$35	+\$0	Nose Screen, black aluminum frame, 3/16"	10001-46333B	\$55	+\$5
Hood Pin Kit, 1/2" pins (5PC)	803	\$38	-\$7	Nose Screen, black aluminum frame, 1/4"	10001-46433B	\$55	+\$5
				Universal Body Mounting Kit, aluminum	000-400K	\$49	+\$20

VINYL NOSE & BUMPER COVER GRAPHIC ID KITS FOR A REALISTIC OEM LOOK!

PRINTED ON OUTDOOR DURABLE HIGH-TACK VINYL • GLOSSY LAMINATED SURFACE PROVIDES EXCELLENT PROTECTION



CHEVROLET SS

Nose ID Kit	680-410-ID	\$37
Bumper Cover ID Kit	680-450-ID	\$36

FORD FUSION

Nose ID Kit	500-410-ID	\$37
Bumper Cover ID Kit	500-450-ID	\$36

TOYOTA CAMRY

Nose ID Kit	740-410-ID	\$37
Bumper Cover ID Kit	740-450-ID	\$36

DODGE CHARGER

Nose ID Kit	470-410-ID	\$37
Bumper Cover ID Kit	470-450-ID	\$36

Dodge Charger Nose & Bumper Cover are only available in Black or White

» GO TO PAGES 124-147 TO SEE ALL ACCESSORIES FOR THIS BODY

PRICING SUBJECT TO CHANGE WITHOUT NOTICE

ABC
LMSC
TRUCK
PAV MODIFIED
OUTLAW LATE MODEL
SPORTSMAN
STREET STOCK
MID3 LATE MODEL
MID3 MODIFIED
DIRT GRAND NATL
T22
PRO STOCK/MOD
FUNNY CAR
WINDOWS
ACCESSORIES

ABC GREENHOUSE STYLE

FEATURED BODY ACCESSORIES

WIDE ANGLE RACING MIRROR:

- » This convex glass mirror gives you the best view of your competition!
- » All black frame with black anodized machined aluminum brackets
- » For more details & ordering info page 146



SPOILER MOUNTING KIT:

- » Everything needed to mount the polycarbonate spoiler blade to the bracket, and the bracket to the bumper cover
- » For more details & ordering info page 138

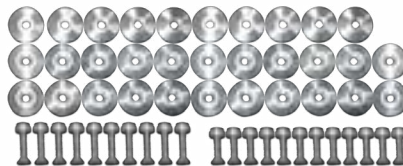

UNIVERSAL BODY MOUNTING KIT:

- » Universal fit that can be used anywhere on a race car
- » Plastic kit features Black Delrin washers that withstand repeated impact and stress
- » For more details & ordering info page 127



PREMIUM AVEX STYLE RIVETS:

- » Five Star Premium Rivets are known as the best quality on the market
- » Super-tight grip and won't spin out while drilling!
- » Grip range of up to 3/16" for 1/8" rivets and up to 1/2" for 3/16" rivets
- » For more details & ordering info page 126

» GO TO PAGES 124-147 TO SEE ALL ACCESSORIES FOR THIS BODY STYLE

ABC GREENHOUSE STYLE

BODY DIMENSIONS

ABC
LMSC
TRUCK
PAV/MODIFIED
OUTLAW/LATE MODEL
SPORTSMAN
STREET STOCK
MOD LATE MODEL
MOD MODIFIED
DIRT GRAND NAT'L
T&Z
PRO STOCK/MOD
FUNNY CAR
WINDOWS
ACCESSORIES

FIVE STAR BODIES ARE DESIGNED TO MAINTAIN PRECISE FIT WITH OPTIMIZED AERODYNAMICS!

WIDTHS

A	B	C
79½" MAX"	68"	67"
Body Width: Measured at wheel wells	Door to Door Width: Measured at A-posts & inside edge of doors, measured through car	Door to Door Width: Measured at B-posts & inside edge of doors, measured through car

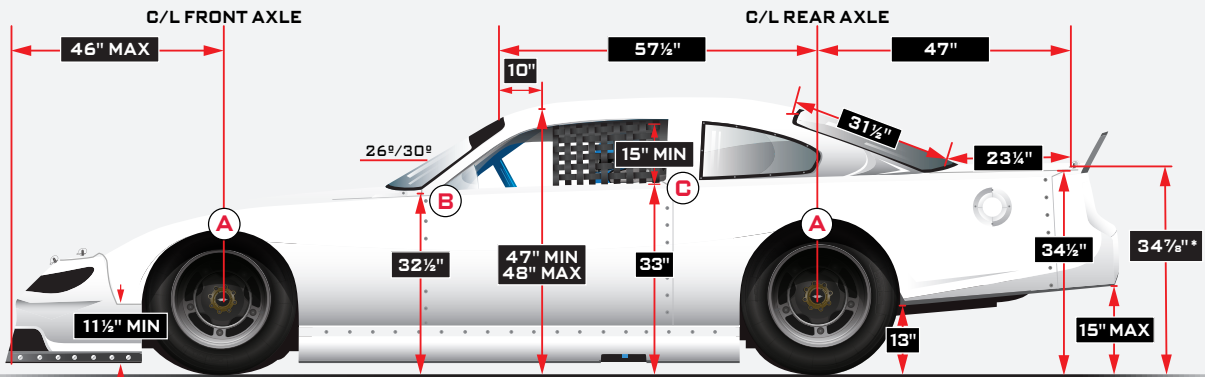

NOTES:

1. If the Roof Height (10" back from windshield), Door Height (rear), Quarter Panel, or Bumper Cover Height dimensions are higher than the stated minimum dimensions, all four must increase by the same amount.

2. Must fit centerline template within allowable tolerance. *Measured at the seam of bumper cover at deck lid intersection, +/- 1/4"

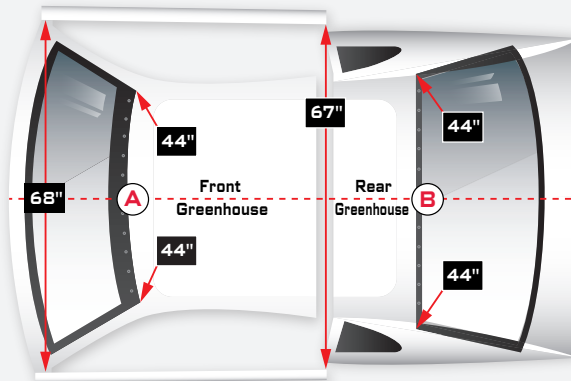

CHASSIS	ROOF HEIGHTS	TREAD WIDTH	WHEELBASE
Offset/ Straight Rail	A 47" B 45½"	66" MAX	101-108"

BODY PANEL



DIMENSIONS

FOR INDIVIDUAL BODY PANEL DIMENSIONS, VISIT FIVESTARBODIES.COM

ABC GREENHOUSE STYLE

BODY MOUNTING FIXTURES

MOUNT YOUR BODY FAST & EASY TO MAXIMIZE PERFORMANCE & TO PASS TECH INSPECTION!

It is the responsibility of all competitors to present a car that fits the templates within allowable tolerances and meets all dimensions as inspected by the "Referee." Be sure to download a free copy of the Official ABC Rulebook for body styles, panels, spoilers, windows, overhangs, roof height, proper placement of templates, and more!



THE OFFICIAL REFEREE 2.0

- » Used by tracks and associations throughout North America for body tech inspection
- » Measure the front overhang of the nose, tread width, roof, door, and deck height, rear overhang, wheelbase, and engine setback
- » Adjustable laser option for accurate measurements of front overhang and engine setback
- » Magnetic, tinted polycarbonate wheel plates for better attachment to wheels
- » Includes Tech Inspector's checklist
- » **NOT NECESSARY FOR MOUNTING A BODY.** A body can easily be installed within specs by using the body dimensions sheets & templates

Referee 2.0	TT-200-00	\$1,975
Wheel Locator, w/magnets (SET OF 4) (SOLD SEPARATELY)	TT-200-WL	\$98
Laser Measurement Assembly (SOLD SEPARATELY)	TT-200-LB	\$150

VISIT OUR YOUTUBE PAGE FOR A TECH VIDEO DEMONSTRATING USE OF THE OFFICIAL REFEREE 2.0



ROOF LOCATING FIXTURE

- » THE FAST & EASY WAY TO MOUNT YOUR COMPLETE BODY WITHOUT THE CHASSIS UNDERNEATH
- » This time-saving device has adjustable quarter panel arms and makes locating the roof on your chassis a simple process
- » Allows exact fit for wheel opening locations, body dimensions, and inspection templates to fit series specs
- » Pre-fits from the cowl to the bumper cover, then can be lifted easily on top of the chassis for final fit
- » Comes in a black powder-coat finish and includes roof brackets, door height blocks and assembly instructions

Roof Locating Fixture (includes Roof Brackets & Door Height Blocks)	809P	\$875
Replacement Roof Brackets	809-1P	\$71
Replacement Door Height Blocks, 7" tall	809-HB	\$38

ABC GREENHOUSE STYLE

TOOLS & TEMPLATES

ABC
LMSC
TRUCK
PAV/MODIFIED
OUTLAW LATE MODEL
SPORTSMAN
STREET STOCK
M03 LATE MODEL
M03 MODIFIED
DIRT GRAND NAT'L
T&Z
PRO STOCK/MOD
FUNNY CAR
WINDOWS
ACCESSORIES



ABC TEMPLATES ENSURE A CORRECT FIT FOR OPTIMUM AERODYNAMICS

- » Complete template set ensures body is installed correctly
- » Complete sets include: Body Centerline, Nose Centerline, Nose Side-to-Side, Fenders, Extended Front Roof Side-to-Side, Extended Rear Roof Side-to-Side, and Rear Deck Side-to-Side
- » Common templates can check all models

Template, Complete Set, wood, Chevrolet SS	660-82	\$361
Template, Complete Set, wood, Ford Fusion	570-82	\$361
Template, Complete Set, wood, Toyota Camry	660-82	\$361
Template, Nose Side-to-Side, wood, Common	XA 672-82NS	\$64
NEW! TEMPLATES: ENHANCED SHAPE CONTROL FOR 2024		
Template, Roof, Front, Side-to-Side, extended, wood, Common	660-84W	\$49
Template, Roof, Rear, Side-to-Side, extended, wood, Common	660-84S	\$49
Template, Rear Deck Lid, wood, Common	660-84RD	\$49

RULEBOOK



QR CODE

» **DOWNLOAD OFFICIAL ABC RULEBOOK @ FIVESTARBODIES.COM**



» **FOR MORE BODY MOUNTING TOOLS, GO TO PAGES 124-147**

PRICING SUBJECT TO CHANGE WITHOUT NOTICE



ABC TRADITIONAL STYLE ROOF

THE ORIGINAL ONE-PIECE ROOF CONFIGURATION

This body design features quarter panels with the quarter window area included and a separate deck lid filler panel.





- » Consistent & repeatable fit for all replacement panels
- » Designed to fit templates perfectly
- » The most durable ABC Traditional body on the market
- » Common body has 4 different noses
- » Available in 4 colors



ABC TRADITIONAL STYLE

BODY PANELS & OPTIONS

HOW TO ORDER YOUR BODY IN 3 QUICK & EASY STEPS

» 1. SELECT BODY PACKAGE » 2. SELECT PANEL COLOR » 3. SELECT NOSE MAKE

RE-SKIN BODY PACKAGE		-W -B	-CB -R
Bumper Cover, Rear, high-impact plastic	460-450-x	\$155	\$160
Door, aluminum, left	661-21A-xL	\$112	\$112
Door, aluminum, right	661-21A-xR	\$112	\$112
Fender, 8" tires (-23-xL) ACT SERIES; 10" tires (-24-xL), high-impact plastic, left (SPECIFY SIZE)	660-2x-xL	\$150	\$154
Fender, 8" tires (-23-xR) ACT SERIES; 10" tires (-24-xR), high-impact plastic, right (SPECIFY SIZE)	660-2x-xR	\$150	\$154
Nose, high-impact plastic (SPECIFY MAKE: CHEVY SS-660; FUSION-570; CAMRY-720; CHARGER-470 IS B/W ONLY)	xxx-410-x	\$164	\$171
Quarter Panel, Ultraglass composite, left	463-270-xL	\$389	\$450
Quarter Panel, Ultraglass composite, right	463-270-xR	\$389	\$450
Rocker Panel, fits either side, high-impact plastic (2 REQUIRED) SPECIFY COLOR: -W -B -CB -R -Y	000-5501P-x	\$33	\$38
Rocker Panel, fits either side, high-impact plastic (ENTERED TWICE TO SHOW PACKAGE PRICE)	000-5501P-x	\$33	\$38
RE-SKIN BODY PACKAGE PRICE		583-100-x	\$1,687 \$1,839

COMPLETE BODY PACKAGE (RE-SKIN COMPONENTS PLUS ITEMS BELOW)		-W -B	-CB -R
Cowl Panel Kit (INCLUDES COWL AIR INSERT AND TABS), ULTRAGLASS COMPOSITE WITH FIRE RETARDANT RESIN	671-5100-x	\$249	\$299
Deck Lid Hold-Down Strip, aluminum	XM 000-310H-x	\$10	\$10
Deck Lid, aluminum	661-310A-x	\$76	\$76
Deck Lid Filler Panel, composite	661-3200-x	\$165	\$188
Roof, 1-piece, composite	661-5102-x	\$340	\$378
Hood, flat, composite	670-3301-x	\$320	\$360
Spoiler, Complete, 4pc, polycarbonate blades & unpainted aluminum brackets, 6-1/2" x 60", 70°	661-6737	\$129	\$129
Window, Quarter, mar-resistant coated, 0.093", left	460-6515BL	\$55	\$55
Window, Quarter, mar-resistant coated, 0.093", right	460-6515BR	\$55	\$55
Window, Rear, uncoated, 0.093"	574-6111-3B	\$201	\$201
Windshield, mar-resistant coated, 1/8"	564-6325-3B	\$357	\$357
COMPLETE BODY PACKAGE PRICE		583-142-x	\$3,644 \$3,947

*ALL WINDOWS ARE PRECUT TO FIT, BEVELED & DRILLED, WITH BLACK-OUT BORDER UNLESS OTHERWISE SPECIFIED.

TO ENHANCE YOUR BODY PACKAGE, CHOOSE FROM THE OPTIONS BELOW:

BODY PACKAGE OPTIONS & UPGRADES (ADD OR SUBTRACT TO PACKAGE PRICE ABOVE FOR TOTAL)		-W -B	+/- PKG PRICE	-CB -R	+/- PKG PRICE
Door, for longer wheelbase, aluminum, left / right (SPECIAL ORDER) (BODY PKG PRICE IS X2)	661-211A-xLorR	\$112	\$0	\$112	\$0
Fender, for 10" tires, Ultraglass composite, left / right (BODY PKG PRICE IS X2)	663-240-xLorR	\$289	+\$139	\$329	+\$175
Fender, for 8" tires, composite, left / right (AVAILABLE ONLY IN BLACK OR WHITE) (BODY PKG PRICE IS X2)	663-230-xLorR	\$169	+\$19	N/A	N/A
Roof, 1-piece, advanced lightweight composite	661-5102L-x	\$624	+\$284	\$624	+\$246
Hood, flat, advanced lightweight composite	670-3301L-x	\$585	+\$265	\$585	+\$225
Hood, scooped, composite (AVAILABLE ONLY IN BLACK OR WHITE) NOT ABC APPROVED	660-3303-x	\$320	\$0	\$320	N/A
Rocker Panels, fits either side, aluminum (BODY PKG PRICE IS X2)	000-5501A-x	\$39	+\$6	\$39	\$1
Cowl Panel Air Deflector, Ultraglass composite (AVAILABLE ONLY IN BLACK)	000-5200A	\$55	-\$194	\$55	N/A
Window, Rear, mar-resistant coated, 0.093"	574-6115-3B	\$315	+\$114	\$315	+\$114
Windshield, mar-resistant coated, 3/16" (FOR ENHANCED DRIVER SAFETY)	564-6335-3B	\$397	+\$40	\$397	+\$40
Spoilers: 60" wide	5" (90°) 5" (70°) 5" (55°) 6-1/2" (90°) 6-1/2" (70°) 6-1/2" (55°)				
Complete, aluminum	661-6749 661-6747 661-6745 661-6739 661-6737 661-6735	\$129	\$0	\$129	+\$0
Complete, aluminum, black	661-6749-B 661-6747-B 661-6745-B 661-6739-B 661-6737-B 661-6735-B	\$139	+\$10	\$139	+\$10

ABC TRADITIONAL STYLE

BODY MOUNTING KIT

» EVERYTHING YOU NEED FOR THAT CLEAN & PROFESSIONAL INSTALL!

COMPLETE BODY MOUNTING KIT SAVE \$\$ WHEN PURCHASING COMPLETE KIT VERSUS INDIVIDUAL COMPONENTS!

Adjustable Body Braces (X3 @ \$35EA)	807-3	\$105
Aluminum Nose Side Braces, pair	000-500	\$39
Door Vent Windows, pair	000-6202	\$35
Front Bumper Mounting Kit	10001-72721	\$132
Front Bumper, 1-3/4", .065" steel	660-7103	\$48
Graphics, Nose ID Kit (SPECIFY MAKE BELOW)	xx0-410-ID	\$37
Graphics, Bumper Cover ID Kit (SPECIFY MAKE BELOW)	xx0-450-ID	\$36
Hood Pin Bracket, 1/2" steel (5 PINS REQUIRED; SPECIFY MAKE PG 129)	xx0-410-HPB	\$35
Hood Pin Kit, 3/8" pins (X3 @ \$15EA) -B -CB -R	10001-34033-x	\$45
Nose Screen, stainless, 3/16"	660-4111	\$50
Rear Bumper Mounting Kit	802-25	\$49
Rear Bumper, 1-3/4", .065" steel	570-7503	\$48
Rear Deck Mounting Kit	660-450-RDK	\$87
Rear Window Brace Kit (3PC)	674-6101	\$76
Right Side Door Support	11002-75533	\$30
Universal Body Mounting Kit, plastic	00001-72651	\$29
Wear Strips, plastic SPECIFY COLOR: -W -B -CB -OR -R -Y -FG -FO -FR -FY	000-400-x	\$35
Window Installation Kit	805	\$23
Windshield Brace Kit (3PC)	564-6301	\$76
COMPLETE KIT PRICE WITH 10% DISCOUNT	800-1D	\$913.50

BODY MOUNTING KIT OPTIONS & UPGRADES (ADD OR SUBTRACT GREEN \$ TO PACKAGE PRICE ABOVE FOR TOTAL)

Front Bumper, 1-3/4" round, .095" steel	660-7103B	\$48	\$0	Nose Screen, 1/4" spacing	660-4112	\$50	\$0
Front Bumper, 1-3/4" round, .095" steel W/12" EXT	660-7103C	\$56	+\$8	Nose Screen, black, 1/4" spacing	660-4112-B	\$55	+\$5
Hood Pin Bracket, 3/4" aluminum (SPECIFY MAKE PG 129)	xx0-411A-HPB	\$66	+\$31	Nose Screen, black, 3/16" spacing	660-4111-B	\$55	+\$5
Hood Pin Bracket, 3/4" steel (SPECIFY MAKE PG 129)	xx0-411-HPB	\$35	+\$0	Nose Screen, black aluminum frame, 3/16"	10001-46333B	\$55	+\$5
Hood Pin Kit, 1/2" pins (5PC)	803	\$38	-\$7	Nose Screen, black aluminum frame, 1/4"	10001-46433B	\$55	+\$5
				Universal Body Mounting, aluminum	000-400K	\$49	+\$20

VINYL NOSE & BUMPER COVER GRAPHIC ID KITS FOR A REALISTIC OEM LOOK!

PRINTED ON OUTDOOR DURABLE HIGH-TACK VINYL • GLOSSY LAMINATED SURFACE PROVIDES EXCELLENT PROTECTION



CHEVROLET SS

Nose ID Kit	680-410-ID	\$37
Bumper Cover ID Kit	680-450-ID	\$36

FORD FUSION

Nose ID Kit	500-410-ID	\$37
Bumper Cover ID Kit	500-450-ID	\$36

TOYOTA CAMRY

Nose ID Kit	740-410-ID	\$37
Bumper Cover ID Kit	740-450-ID	\$36

DODGE CHARGER

Nose ID Kit	470-410-ID	\$37
Bumper Cover ID Kit	470-450-ID	\$36

Dodge Charger Nose & Bumper Cover are only available in Black or White

» GO TO PAGES 124-147 TO SEE ALL ACCESSORIES FOR THIS BODY

PRICING SUBJECT TO CHANGE WITHOUT NOTICE

ABC
LMSC
TRUCK
PAV MODIFIED
OUTLAW LATE MODEL
SPORTSMAN
STREET STOCK
MID3 LATE MODEL
MID3 MODIFIED
DIRT GRAND NATL
T42
PRO STOCK/MOD
FUNNY CAR
WINDOWS
ACCESSORIES

ABC TRADITIONAL STYLE

FEATURED BODY ACCESSORIES



COWL INDUCTION COLD AIR BOXES:

- » 4 barrel and 2 barrel offset options available
- » Flow bench tested for peak air flow
- » For more details & ordering info page 134

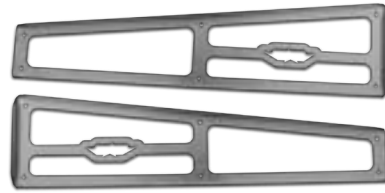

QUARTER PANEL BODY BRACE KIT:

- » Stiffens the quarter panel to maintain correct shape in an aero sensitive area
- » Highly recommend bracing for tracks 1/2-mile and longer
- » Laser-cut aluminum braces have pre-drilled holes for brace attachment
- » For more details & ordering info page 142



UNIVERSAL BODY MOUNTING KIT:

- » Universal fit that can be used anywhere on a race car
- » Plastic kit features Black Delrin washers that withstand repeated impact and stress
- » For more details & ordering info page 127



PREMIUM AVEX STYLE RIVETS:

- » Five Star Premium Rivets are known as the best quality on the market
- » Super-tight grip and won't spin out while drilling!
- » Grip range of up to 3/16" for 1/8" rivets and up to 1/2" for 3/16" rivets
- » For more details & ordering info page 126

» GO TO PAGES 124-147 TO SEE ALL ACCESSORIES FOR THIS BODY STYLE

ABC TRADITIONAL STYLE

BODY DIMENSIONS

FIVE STAR BODIES ARE DESIGNED TO MAINTAIN PRECISE FIT WITH OPTIMIZED AERODYNAMICS!

WIDTHS

A	B	C
79½ MAX"	68"	67"

Body Width: Measured at wheel wells

Door to Door Width: Measured at A-posts & inside edge of doors, measured through car

Door to Door Width: Measured at B-posts & inside edge of doors, measured through car

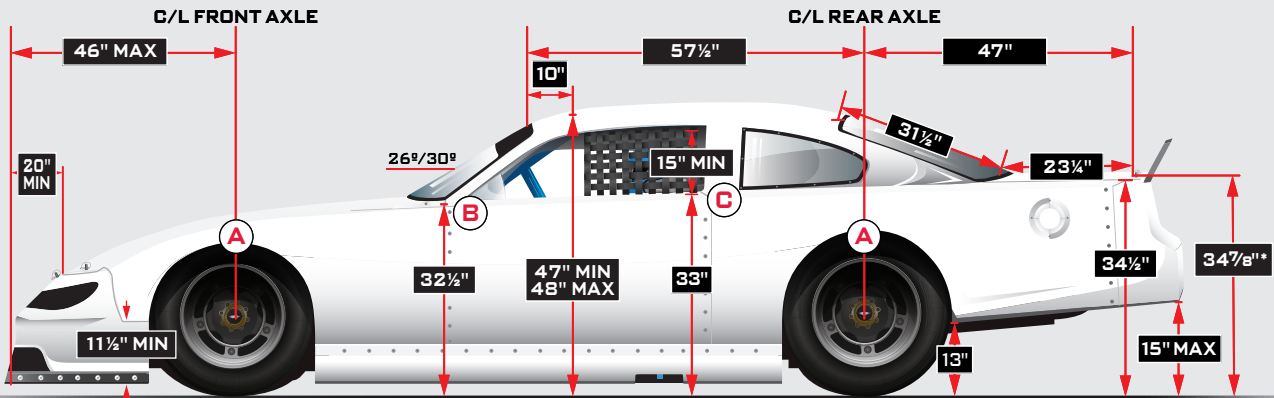

NOTES:

1. If the Roof Height (10" back from windshield), Door Height (rear), Quarter Panel, or Bumper Cover Height dimensions are higher than the stated minimum dimensions, all four must increase by the same amount.

2. Must fit centerline template within allowable tolerance. *Measured at the seam of bumper cover at deck lid intersection, +/- 1/4"

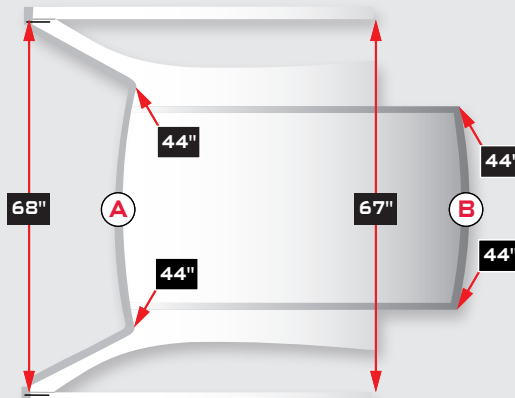

CHASSIS	ROOF HEIGHTS	TREAD WIDTH	WHEELBASE
Offset/ Straight Rail	A 47" B 45½"	66" MAX	101-108"

BODY PANEL



DIMENSIONS

» FOR INDIVIDUAL BODY PANEL DIMENSIONS, VISIT FIVESTARBODIES.COM

ABC TRADITIONAL STYLE

BODY MOUNTING FIXTURES

MOUNT YOUR BODY FAST & EASY TO MAXIMIZE PERFORMANCE & TO PASS TECH INSPECTION!

It is the responsibility of all competitors to present a car that fits the templates within allowable tolerances and meets all dimensions as inspected by the "Referee." Be sure to download a free copy of the Official ABC Rulebook for body styles, panels, spoilers, windows, overhangs, roof height, proper placement of templates, and more!



THE OFFICIAL REFEREE 2.0

- » Used by tracks and associations throughout North America for body tech inspection
- » Measure the front overhang of the nose, tread width, roof, door, and deck height, rear overhang, wheelbase, and engine setback
- » Adjustable laser option for accurate measurements of front overhang and engine setback
- » Magnetic, tinted polycarbonate wheel plates for better attachment to wheels
- » Includes Tech Inspector's checklist
- » **NOT NECESSARY FOR MOUNTING A BODY.** A body can easily be installed within specs by using the body dimensions sheets & templates

Referee 2.0	TT-200-00	\$1,975
Wheel Locator, w/magnets (SET OF 4) (SOLD SEPARATELY)	TT-200-WL	\$98
Laser Measurement Assembly (SOLD SEPARATELY)	TT-200-LB	\$150

VISIT OUR YOUTUBE PAGE FOR A TECH VIDEO DEMONSTRATING USE OF THE OFFICIAL REFEREE 2.0

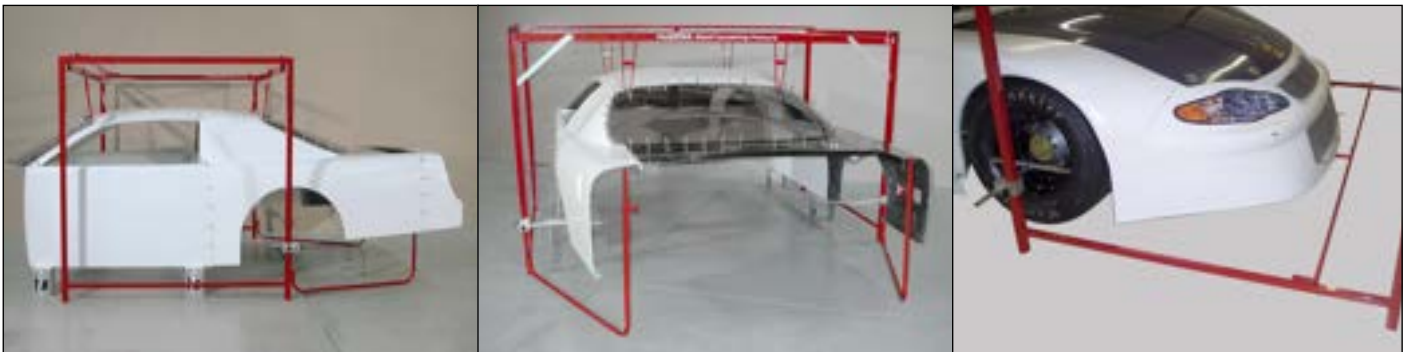

ROOF LOCATING FIXTURE

- » THE FAST & EASY WAY TO MOUNT YOUR COMPLETE BODY WITHOUT THE CHASSIS UNDERNEATH
- » This time-saving device has adjustable quarter panel arms and makes locating the roof on your chassis a simple process
- » Allows exact fit for wheel opening locations, body dimensions, and inspection templates to fit series specs
- » Pre-fits from the cowl to the bumper cover, then can be lifted easily on top of the chassis for final fit
- » Comes in a black powder-coat finish and includes roof brackets, door height blocks and assembly instructions

Roof Locating Fixture (includes Roof Brackets & Door Height Blocks)	809P	\$875
Replacement Roof Brackets	809-1P	\$71
Replacement Door Height Blocks, 7" tall	809-HB	\$38

ABC TRADITIONAL STYLE

TOOLS & TEMPLATES

ABC
LMSC
TRUCK
PAV/MODIFIED
OUTLAW/LATE MODEL
SPORTSMAN
STREET STOCK
M03 LATE MODEL
M03 MODIFIED
DIRT GRAND NAT'L
T&Z
PRO STOCK/MOD
FUNNY CAR
WINDOWS
ACCESSORIES



ABC TEMPLATES ENSURE A CORRECT FIT FOR OPTIMUM AERODYNAMICS

- » Complete template set ensures body is installed correctly
- » Complete sets include: Body Centerline, Nose Centerline, Nose Side-to-Side, Fenders, Extended Front Roof Side-to-Side, Extended Rear Roof Side-to-Side, and Rear Deck Side-to-Side
- » Common templates can check all models

Template, Complete Set, wood, Chevrolet SS	660-82	\$361
Template, Complete Set, wood, Ford Fusion	570-82	\$361
Template, Complete Set, wood, Toyota Camry	660-82	\$361
Template, Nose Side-to-Side, wood, Common	XA 672-82NS	\$64
NEW! TEMPLATES: ENHANCED SHAPE CONTROL FOR 2024		
Template, Roof, Front, Side-to-Side, extended, wood, Common	660-84W	\$49
Template, Roof, Rear, Side-to-Side, extended, wood, Common	660-84S	\$49
Template, Rear Deck Lid, wood, Common	660-84RD	\$49

RULEBOOK



QR CODE

» **DOWNLOAD OFFICIAL ABC RULEBOOK @ FIVESTARBODIES.COM**



» **FOR MORE BODY MOUNTING TOOLS, GO TO PAGES 124-147**

PRICING SUBJECT TO CHANGE WITHOUT NOTICE



NEXTGEN LATE MODEL STOCK

THE MULTI-TIME NATIONAL CHAMPIONSHIP BODY

The NextGen Late Model Stock Car Body is the latest in high-performance engineering, setting a new standard for durability and aerodynamics in the late model stock racing world.

This body is hassle free for any racer to install.



- » Enhanced safety with the use of flame-retardant resin in the Ultraglass Composite greenhouse
- » Exceptional aero balance achieved and validated through extensive wind tunnel and on track testing
- » All panels have consistent & repeatable fit for effortless installation & replacement
- » Panels have mounting flanges & locating tabs
- » Commonly raced in NASCAR LMSC divisions and CARS Tour Series
- » Common body has 3 nose options for brand identity
- » Two-piece greenhouse includes a built-in cowl and deck lid filler
- » Designed to fit perimeter-style chassis
- » Available in 4 colors



LATE MODEL STOCK

BODY PANELS & OPTIONS

HOW TO ORDER YOUR BODY IN 3 QUICK & EASY STEPS

» 1. SELECT BODY PACKAGE » 2. SELECT PANEL COLOR » 3. SELECT NOSE MAKE

RE-SKIN BODY PACKAGE

		-W -B	-CB -R
Bumper Cover, Rear, high-impact plastic	11002-45051-x	\$155	\$160
Door, aluminum, left	13002-21033-xL	\$112	\$112
Door, aluminum, right	13002-21033-xR	\$112	\$112
Fender, high-impact plastic, left	11002-23051-xL	\$150	\$154
Fender, high-impact plastic, right	13002-23051-xR	\$150	\$154
Nose, high-impact plastic (SPECIFY MAKE: CAMARO-11132; MUSTANG-11322; CAMRY-11712)	11xxx-41051-x	\$164	\$171
Quarter Panel, Ultraglass composite, left	13002-27313-xL	\$314	\$370
Quarter Panel, Ultraglass composite, right	13002-27313-xR	\$314	\$370
Rocker Panel, fits either side, high-impact plastic (2 REQUIRED) SPECIFY COLOR: -W -B -CB -R -Y	000-5501P-x	\$33	\$38
Rocker Panel, fits either side, high-impact plastic (ENTERED TWICE TO SHOW PACKAGE PRICE)	000-5501P-x	\$33	\$38
RE-SKIN BODY PACKAGE PRICE		13002-10000-x	\$1,537 \$1,679

COMPLETE BODY PACKAGE (RE-SKIN COMPONENTS PLUS ITEMS BELOW)

		-W -B	-CB -R
Deck Lid Hold-Down Strip, aluminum	XM 000-310H-x	\$10	\$10
Deck Lid, aluminum	661-310A-x	\$76	\$76
Greenhouse, Front, Ultraglass composite with fire retardant resin	13002-51313-x	\$715	\$780
Greenhouse, Rear, Ultraglass composite with fire retardant resin	13002-51513-x	\$699	\$774
Hood, oversized, composite	11002-33011-x	\$320	\$360
Spoiler, Complete, 2pc, unpainted aluminum blades, 5" x 64.5", 55°	13002-47555	\$115	\$115
Windshield, mar-resistant coated, 1/8"	13002-63253	\$357	\$357
Window, Quarter, mar-resistant coated, 0.093", left	11002-65153-L	\$55	\$55
Window, Quarter, mar-resistant coated, 0.093", right	11002-65153-R	\$55	\$55
Window, Rear, uncoated, 0.093"	11002-61151	\$201	\$201
COMPLETE BODY PACKAGE PRICE		13002-10600-x	\$4,140 \$4,462

*ALL WINDOWS ARE PRECUT TO FIT, BEVELED & DRILLED, WITH BLACK-OUT BORDER UNLESS OTHERWISE SPECIFIED.

TO ENHANCE YOUR BODY PACKAGE, CHOOSE FROM THE OPTIONS BELOW:

BODY PACKAGE OPTIONS & UPGRADES (ADD OR SUBTRACT TO PACKAGE PRICE ABOVE FOR TOTAL)

		-W -B	+/- PKG PRICE	-CB -R	+/- PKG PRICE
Door, with fender mounting recess, aluminum, left / right (BODY PKG PRICE IS X2)	13002-21233-xLorR	\$112	\$0	\$112	\$0
Door, for longer wheelbase, aluminum, left / right (SPECIAL ORDER) (BODY PKG PRICE IS X2)	13002-21133-xLorR	\$112	\$0	\$112	\$0
Fender, Ultraglass composite, left	11002-23013-xL	\$285	+\$135	\$319	+\$165
Fender, Ultraglass composite, right	13002-23013-xR	\$285	+\$135	\$319	+\$165
Rocker Panels, fits either side, aluminum (BODY PKG PRICE IS X2)	000-5501A-x	\$39	+\$6	\$39	\$1
Hood, oversized, advanced lightweight composite	11002-33011L-x	\$619	+\$299	\$619	+\$259
Spoiler, Complete, 2pc, black aluminum blades & brackets, 5" x 64.5", 55°	13002-47555-B	\$125	+\$10	\$125	+\$10
Spoiler, Complete, 4pc, 3/16" poly blades, unpainted aluminum brackets, 5" x 64.5", 55°	13002-47355	\$129	+\$14	\$129	+\$14
Spoiler, Complete, 4pc, 3/16" poly blades, black aluminum brackets, 5" x 64.5", 55°	13002-47355-B	\$139	+\$24	\$139	+\$24
Window, Rear, mar-resistant coated, .093"	11002-61153	\$347	+\$146	\$347	+\$146
Windshield, mar-resistant coated, 3/16" (FOR ENHANCED DRIVER SAFETY)	13002-63353	\$437	+\$80	\$437	+\$80

OLDER STYLE



BODY PANELS

LATE MODEL STOCK

BODY MOUNTING KIT

» EVERYTHING YOU NEED FOR THAT CLEAN & PROFESSIONAL INSTALL!

COMPLETE BODY MOUNTING KIT SAVE \$\$ WHEN PURCHASING COMPLETE KIT VERSUS INDIVIDUAL COMPONENTS!

Adjustable Body Braces (X3 @ \$35EA)	807-3	\$105
Aluminum Nose Side Braces, pair	11002-75333	\$14
Door Vent Windows, pair	11002-66222	\$33
Front Bumper Mounting Kit	10001-72721	\$132
Front Bumper, 1-3/4", .065" steel	13002-71182	\$48
Graphics, Nose ID Kit (SPECIFY MAKE BELOW)	11xx2-44141	\$37
Graphics, Bumper Cover ID Kit (SPECIFY MAKE BELOW)	11xx2-44541	\$36
Hood Pin Bracket, 3/4" steel (4 PINS REQUIRED)	11002-34331	\$35
Hood Pin Kit, 3/8" pins (X2 @ \$15EA) SPECIFY COLOR: -B -CB -R	10001-34033-x	\$30
Nose Screen, stainless, 3/16"	660-4111	\$50
Rear Bumper Mounting Kit	802-2S	\$49
Rear Bumper, 1-3/4", .065" steel	11002-71682	\$48
Rear Deck Mounting Kit	660-450-RDK	\$87
Rear Window Brace Kit (3PC)	11002-76133	\$76
Universal Body Mounting, plastic	00001-72651	\$29
Wear Strips, plastic SPECIFY COLOR: -W -B -CB -OR -R -Y -FG -FO -FR -FY	11002-41551-x	\$35
Window Installation Kit	805	\$23
Windshield Brace Kit (3PC)	13002-76333	\$76
COMPLETE KIT PRICE WITH 10% DISCOUNT 13002-72520		\$848.70

BODY MOUNTING KIT OPTIONS & UPGRADES (ADD OR SUBTRACT GREEN \$ TO PACKAGE PRICE ABOVE FOR TOTAL)

Front Bumper, 1-3/4" round, .095" steel	13002-71185	\$48	\$0	Nose Screen, black, 1/4" spacing	660-4112-B	\$55	+\$5
Front Bumper, 1-3/4" round, .095" steel W/ 12" EXT.	13002-71188	\$56	+\$8	Nose Screen, black, 3/16" spacing	660-4111-B	\$55	+\$5
Hood Pin Bracket, 3/4" aluminum	11002-34333	\$66	+\$31	Nose Screen, black aluminum frame, 3/16"	10001-46333B	\$55	+\$5
Hood Pin Kit, 1/2" pins (5pc)	803	\$38	+\$8	Nose Screen, black aluminum frame, 1/4"	10001-46433B	\$55	+\$5
Nose Screen, 1/4" spacing	660-4112	\$50	\$0	Universal Body Mounting, aluminum	000-400K	\$49	+\$20

VINYL NOSE & BUMPER COVER GRAPHIC ID KITS FOR A REALISTIC OEM LOOK!

PRINTED ON OUTDOOR DURABLE HIGH-TACK VINYL • GLOSSY LAMINATED SURFACE PROVIDES EXCELLENT PROTECTION



CHEVROLET CAMARO

Nose ID Kit	11132-44141	\$37
Bumper Cover ID Kit	11132-44542	\$36



FORD MUSTANG

Nose ID Kit	11322-44141	\$37
Bumper Cover ID Kit	11322-44541	\$36



TOYOTA CAMRY

Nose ID Kit	11712-44141	\$37
Bumper Cover ID Kit	11712-44541	\$36

» GO TO PAGES 124-147 TO SEE ALL ACCESSORIES FOR THIS BODY

PRICING SUBJECT TO CHANGE WITHOUT NOTICE

LATE MODEL STOCK

FEATURED BODY ACCESSORIES



ALUMINUM HOOD HINGE KITS:

- » Hinged hoods create easy access to the engine compartment
- » Long and Short Hood Hinge Kit options include Laser cut aluminum hinge, pin, and clip assembly.
- » For more details & ordering info page 131

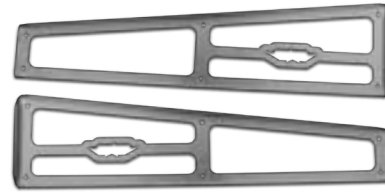

QUARTER PANEL BODY BRACE KIT:

- » Stiffens the quarter panel to maintain correct shape in an aero sensitive area
- » Highly recommend bracing for tracks 1/2-mile and longer
- » Laser-cut aluminum braces have pre-drilled holes for brace attachment
- » For more details & ordering info page 142



ALUMINUM NOSE SIDE BRACES:

- » Provides structure to an aero critical part of the car
- » Laser-cut aluminum is pre-drilled for riveting to the nose and for mounting body braces
- » For more details & ordering info page 130



PREMIUM AVEX STYLE RIVETS:

- » Five Star Premium Rivets are known as the best quality on the market
- » Super-tight grip and won't spin out while drilling!
- » Grip range of up to 3/16" for 1/8" rivets and up to 1/2" for 3/16" rivets
- » For more details & ordering info page 126

» GO TO PAGES 124-147 TO SEE ALL ACCESSORIES FOR THIS BODY STYLE

LATE MODEL STOCK

BODY DIMENSIONS

FIVE STAR BODIES ARE DESIGNED TO MAINTAIN PRECISE FIT WITH OPTIMIZED AERODYNAMICS!

WIDTHS

A	B
67"	65½"

Door to Door Width: Measured at A-posts & inside edge of doors, measured through car

Door to Door Width: Measured at B-posts & inside edge of doors, measured through car

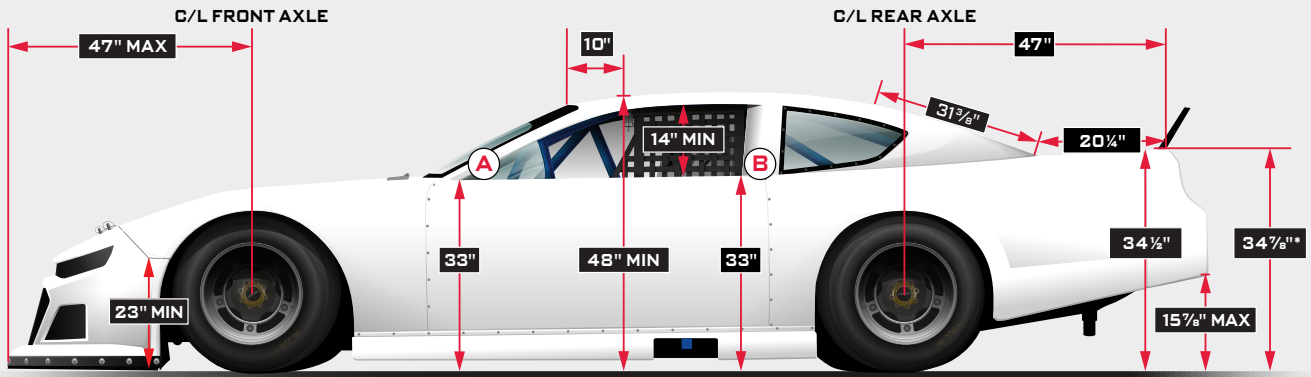

NOTES:

1. If the Roof Height (10" back from windshield), Door Height (rear), Quarter Panel, or Bumper Cover Height dimensions are higher than the stated minimum dimensions, all four must increase by the same amount.

2. Must fit centerline template within allowable tolerance. *Measured at the seam of bumper cover at deck lid intersection, +/- 1/4"

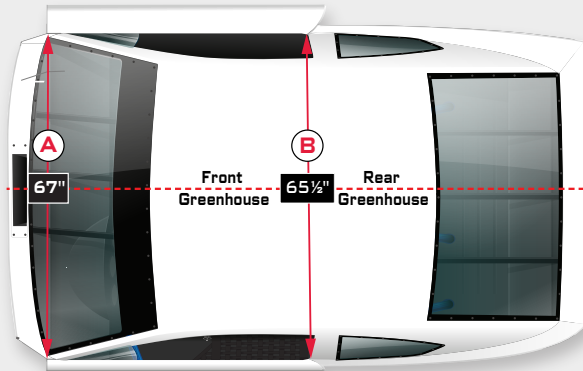

CHASSIS	ROOF HEIGHT	TREAD WIDTH	WHEELBASE
LMSC Perimeter	48"	Up to 64½"	Up to 106"

BODY PANEL



DIMENSIONS

» FOR INDIVIDUAL BODY PANEL DIMENSIONS, VISIT FIVESTARBODIES.COM

LATE MODEL STOCK

BODY MOUNTING FIXTURES

MOUNT YOUR BODY FAST & EASY TO MAXIMIZE PERFORMANCE & TO PASS TECH INSPECTION!

It is the responsibility of all competitors to present a car that fits the templates within allowable tolerances and meets all dimensions as inspected by the "Referee." Be sure to download a free copy of the Official ABC Rulebook for body styles, panels, spoilers, windows, overhangs, roof height, proper placement of templates, and more!



THE OFFICIAL REFEREE 2.0

- » Used by tracks and associations throughout North America for body tech inspection
- » Measure the front overhang of the nose, tread width, roof, door, and deck height, rear overhang, wheelbase, and engine setback
- » Adjustable laser option for accurate measurements of front overhang and engine setback
- » Magnetic, tinted polycarbonate wheel plates for better attachment to wheels
- » Includes Tech Inspector's checklist
- » **NOT NECESSARY FOR MOUNTING A BODY.** A body can easily be installed within specs by using the body dimensions sheets & templates

Referee 2.0	TT-200-00	\$1,975
Wheel Locator, w/magnets (SET OF 4) (SOLD SEPARATELY)	TT-200-WL	\$98
Laser Measurement Assembly (SOLD SEPARATELY)	TT-200-LB	\$150

VISIT OUR YOUTUBE PAGE FOR A TECH VIDEO DEMONSTRATING USE OF THE OFFICIAL REFEREE 2.0



ROOF LOCATING FIXTURE

- » THE FAST & EASY WAY TO MOUNT YOUR COMPLETE BODY WITHOUT THE CHASSIS UNDERNEATH
- » This time-saving device has adjustable quarter panel arms and makes locating the roof on your chassis a simple process
- » Allows exact fit for wheel opening locations, body dimensions, and inspection templates to fit series specs
- » Pre-fits from the cowl to the bumper cover, then can be lifted easily on top of the chassis for final fit
- » Comes in a black powder-coat finish and includes roof brackets, door height blocks and assembly instructions

Roof Locating Fixture (INCLUDES ROOF BRACKETS & DOOR HEIGHT BLOCKS)	809P	\$875
Replacement Roof Brackets	13002-72231	\$71
Replacement Door Height Blocks, 6" tall	11002-72331	\$38

LATE MODEL STOCK

TOOLS & TEMPLATES



LATE MODEL STOCK TEMPLATES ENSURE A CORRECT FIT FOR OPTIMUM AERODYNAMICS

- » Complete template set ensures body is installed correctly
- » Complete sets include: Body Centerline, Fenders, Nose Centerline, Nose Side-to-Side, Front & Rear Roof Side-to-Side
- » Nose and fender templates are specific to model
- » Common templates can check all models
- » Master sets available with templates for all models

Template, Complete Set, wood, Chevrolet Camaro	13132-82091	\$276
Template, Complete Set, wood, Ford Mustang	13322-82091	\$276
Template, Complete Set, wood, Toyota Camry	13712-82091	\$276
Template, Master Set, wood, all models	13002-82091	\$430



» DOWNLOAD OFFICIAL LMSJ RULEBOOK @ FIVESTARBODIES.COM



» FOR MORE BODY MOUNTING TOOLS, GO TO PAGES 124-147

PRICING SUBJECT TO CHANGE WITHOUT NOTICE



SHORT TRACK TRUCK

DELIVERING TOP OF THE LINE PERFORMANCE

This is the latest truck style on the market! The Short Track Truck Body is the prevalent choice in the Midwest Truck Series, highlighting its superior quality & capability.





- » Common body uses different upper noses for brand identity
Chevy, Ford, Toyota, Dodge
- » Easy to install roof has a built-in cowl and windshield base
- » 4 piece nose for quick and easy replacement
- » Fits 8" and 10" tires
- » Available in 2 colors



SHORT TRACK TRUCK

BODY PANELS & OPTIONS

HOW TO ORDER YOUR BODY IN 3 QUICK & EASY STEPS

» 1. SELECT BODY PACKAGE » 2. SELECT PANEL COLOR » 3. SELECT NOSE MAKE

RE-SKIN BODY PACKAGE

-W -B

Bumper Cover, Rear, high-impact plastic	21001-45051-x	\$162
Door, aluminum, left	21001-21033-xL	\$116
Door, aluminum, right	21001-21033-xR	\$116
Fender, high-impact plastic, left	21001-23051-xL	\$156
Fender, high-impact plastic, right	21001-23051-xR	\$156
Nose, Lower, high-impact plastic	81001-41151-x	\$155
Nose, Upper, high-impact plastic (SPECIFY MAKE: SILVERADO-21191; F-150-21341; RAM/TUNDRA-21721)	21xx1-41051-x	\$117
Bed Side, aluminum, left	21001-27333-xL	\$166
Bed Side aluminum, right	21001-27333-xR	\$166
Rocker Panel, fits either side, high-impact plastic (2 REQUIRED) SPECIFY COLOR: -W -B -CB -R -Y	000-5501P-x	\$33
Rocker Panel, fits either side, high-impact plastic (ENTERED TWICE TO SHOW PACKAGE PRICE)	000-5501P-x	\$33
RE-SKIN BODY PACKAGE PRICE	21001-10000-x	\$1,376

COMPLETE BODY PACKAGE (RE-SKIN COMPONENTS PLUS ITEMS BELOW)

-W -B

Bed Cover #1, Front Section, aluminum	T000-351A-x	\$78
Bed Cover #2, Center Section, aluminum	T000-352A-x	\$142
Bed Cover #3, Rear Section, aluminum	T000-353A-x	\$78
Greenhouse, Front, composite	21001-51311-x	\$528
Greenhouse, Rear, composite	21001-51511-x	\$296
Hood, composite	21001-33011-x	\$320
Rear Cab Filler Panel, aluminum	T220-3200-x	\$52
Cowl Air Insert, composite	661-5100A-x	\$68
Spoiler, 1pc, .080" aluminum, 5" x 60"	000-6702	\$40
Window, Rear, uncoated, .093 (REQUIRES TRIMMING, PRECUT TO FIT ON BOTTOM ONLY)	21001-61151	\$68
Windshield, mar-resistant coated, w/ blackout border, 1/8"	21001-63253	\$315
COMPLETE BODY PACKAGE PRICE	21001-10600-x	\$3,361

TO ENHANCE YOUR BODY PACKAGE, CHOOSE FROM THE OPTIONS BELOW:

BODY PACKAGE OPTIONS & UPGRADES (ADD OR SUBTRACT TO PACKAGE PRICE ABOVE FOR TOTAL)

-W -B

+/- PKG PRICE

Rocker Panels, fits either side, aluminum (2 REQUIRED) SPECIFY COLOR: -W -B -CB -R	000-5501A-x	\$39	\$6
Spoiler, 1pc, .080 aluminum, 5" X 65"	T000-6702	\$40	\$0
Spoiler, 1pc, 1/8" polycarbonate, 5" x 60"	000-6701	\$40	\$0
Window, Rear, mar-resistant coated, .093	21001-61153	\$131	\$63

OLDER STYLE



BODY PANELS

FOR OLDER SHORT TRACK TRUCK BODY PANELS & OPTIONS, VISIT OUR WEBSITE!

SHORT TRACK TRUCK

BODY MOUNTING KIT

» EVERYTHING YOU NEED FOR THAT CLEAN & PROFESSIONAL INSTALL!

COMPLETE BODY MOUNTING KIT SAVE \$\$ WHEN PURCHASING COMPLETE KIT VERSUS INDIVIDUAL COMPONENTS!

Adjustable Body Braces (X3 @ \$35EA)	807-3	\$105
Aluminum Nose Side Braces, pair	11002-75333	\$14
Front Bumper Mounting Kit	10001-72721	\$132
Front Bumper, 1-1/2", .065" steel	21001-71162	\$48
Graphics, Nose ID Kit (SPECIFY MAKE BELOW)	21xx1-44141	\$37
Graphics, Bumper Cover ID Kit (SPECIFY MAKE BELOW)	21xx1-44541	\$36
Hood Pin Bracket, 1/2" steel (4 PINS REQUIRED)	21001-34131	\$35
Hood Pin Kit, 3/8" pins (X2 @ \$15EA) SPECIFY COLOR: -B -CB -R	10001-34033-x	\$30
Nose Screen, black, 1/4"	81001-46433B	\$55
Rear Bumper Mounting Kit	802-25	\$49
Rear Bumper, 1-3/4", .065" steel	T000-7503	\$48
Right Side Door Support	11002-75533	\$30
Window Installation Kit	805	\$23
Windshield Brace Kit (3PC)	21001-76333	\$76
COMPLETE KIT PRICE WITH 10% DISCOUNT	21001-72520	\$646.20

VINYL NOSE & BUMPER COVER GRAPHIC ID KITS FOR A REALISTIC OEM LOOK!

PRINTED ON OUTDOOR DURABLE HIGH-TACK VINYL • GLOSSY LAMINATED SURFACE PROVIDES EXCELLENT PROTECTION



CHEVROLET SILVERADO

Nose ID Kit	21191-44141	\$37
Bumper Cover ID Kit	21191-44541	\$36



FORD F-150

Nose ID Kit	21341-44141	\$37
Bumper Cover ID Kit	21341-44541	\$36



DODGE RAM

Nose ID Kit	21591-44141	\$37
Bumper Cover ID Kit	21591-44541	\$36



TOYOTA TUNDRA

Nose ID Kit	21721-44141	\$37
Bumper Cover ID Kit	21721-44541	\$36

» GO TO PAGES 124-147 TO SEE ALL ACCESSORIES FOR THIS BODY

PRICING SUBJECT TO CHANGE WITHOUT NOTICE

SHORT TRACK TRUCK

FEATURED BODY ACCESSORIES

PREMIUM AVEX STYLE RIVETS:

- » Five Star Premium Rivets are known as the best quality on the market
- » Super-tight grip and won't spin out while drilling!
- » Grip range of up to 3/16" for 1/8" rivets and up to 1/2" for 3/16" rivets
- » For more details & ordering info page 126

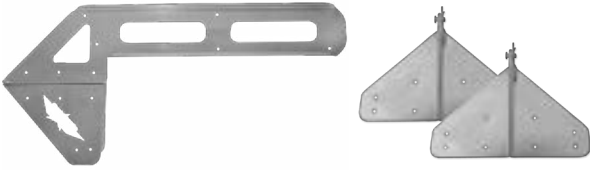

ALUMINUM HOOD HINGE KITS:

- » Hinged hoods create easy access to the engine compartment
- » Long and Short Hood Hinge Kit options include Laser cut aluminum hinge, pin, and clip assembly.
- » For more details & ordering info page 131



LOWER NOSE SCREEN

- » Protects the radiator from debris penetration
- » Frame is laser cut from lightweight aluminum
- » Screen is high strength stainless steel (1/4" MESH IS WELDED)
- » Durable black powder-coated finish
- » Weighs only 10.32oz

Nose Screen, common	81001-464338	\$55
---------------------	--------------	------



CHASSIS CLAMPS:

- » Universal mount fits anywhere bracing is needed
- » Eliminate the need for welding or use of hose clamps when mounting body braces
- » Ideal for use with all Five Star's Adjustable Body Braces
- » For more details & ordering info page 145

» GO TO PAGES 124-147 TO SEE ALL ACCESSORIES FOR THIS BODY STYLE

SHORT TRACK TRUCK

BODY DIMENSIONS & TEMPLATES

FIVE STAR BODIES ARE DESIGNED TO MAINTAIN PRECISE FIT WITH OPTIMIZED AERODYNAMICS!

Make sure your body fits our template package and dimension specs to maximize performance and to pass tech inspection!

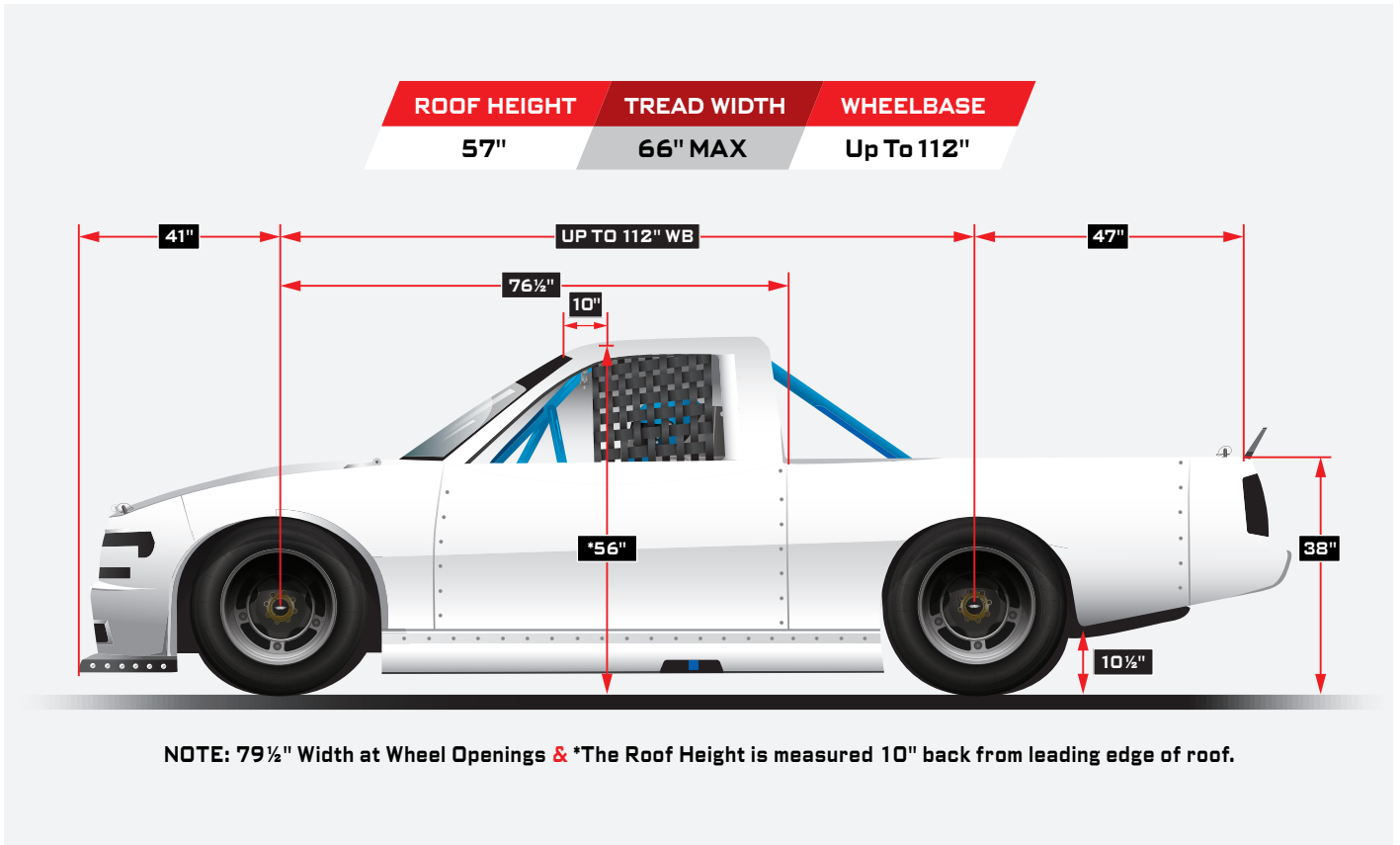

SHORT TRACK TRUCK TEMPLATES ENSURE A CORRECT FIT FOR OPTIMUM AERODYNAMICS

- » Complete template set ensures body is installed correctly
- » Complete sets include: Body Centerline, Nose Centerline, & Rear Roof Side-to-Side
- » Common templates can check all models

Template, Complete Set, aluminum, common	21001-82033	\$339
Template, Complete Set, wood, common	21001-82091	\$95

» FOR MORE BODY MOUNTING TOOLS, GO TO PAGES 124-147

BODY PANEL



DIMENSIONS

» FOR INDIVIDUAL BODY PANEL DIMENSIONS, VISIT FIVESTARBODIES.COM



PAVEMENT MODIFIED

THE ULTIMATE AERODYNAMIC DESIGN

This body features an aerodynamically superior roof
with built-in vortex generators
to enhance airflow.



- » Rear wheel flares enhance aerodynamics and add rigidity to the side while protecting the tires from being cut
- » Roof has built in vortex generators to enhance airflow
- » Roof design is the easiest to install
- » This roof has a built in cowl panel and separate rear window mounting flange
- » Repeatable fit for all replacement panels
- » Fits most short track modified chassis
- » Legal in all major modified series
- » Panels available in 4 colors



PAVEMENT MODIFIED

BODY PANELS & OPTIONS

HOW TO ORDER YOUR BODY IN 3 QUICK & EASY STEPS

» 1. SELECT BODY PACKAGE » 2. SELECT PANEL COLOR » 3. SELECT NOSE MAKE

COMPLETE BODY PACKAGE	CAMARO	MUSTANG	-W -B	-CB -R	-FG -FO -FR -FY
Door, aluminum, left	020-21A-xL	020-21A-xL	\$112	\$112	N/A
Door, aluminum, right	020-21A-xR	020-21A-xR	\$112	\$112	N/A
Hood, center, aluminum	020-33AC-x	020-33AC-x	\$112	\$112	N/A
Hood, side, composite, left	020-330-xL	020-330-xL	\$115	\$145	N/A
Hood, side, composite, right	020-330-xR	020-330-xR	\$115	\$145	N/A
Nose, high-impact plastic, center (ALSO AVAILABLE IN ORANGE)	020-410-xC	020-410-xC	\$52	\$52	N/A
Nose, high-impact plastic, left (ALSO AVAILABLE IN ORANGE)	020-410-xL	020-410-xL	\$87	\$87	N/A
Nose, high-impact plastic, right (ALSO AVAILABLE IN ORANGE)	020-410-xR	020-410-xR	\$87	\$87	N/A
Nose Filler Panel, aluminum	020-4101A-x	020-4101A-x	\$35	\$35	N/A
Quarter Panel, aluminum, left	020-27A-xL	020-27A-xL	\$123	\$123	N/A
Quarter Panel, aluminum, right	020-27A-xR	020-27A-xR	\$123	\$123	N/A
Rear Filler Panel, aluminum	020-450A-x	020-450A-x	\$38	\$38	N/A
Roof, composite	022-5102-x	025-5102-x	\$523	\$560	N/A
Sail Panel, composite, left	022-280-xL	025-280-xL	\$85	\$96	N/A
Sail Panel, composite, right	022-280-xR	025-280-xR	\$85	\$96	N/A
Rocker Panel, high-impact plastic (x3 at \$43 each) (ALSO AVAILABLE IN ORANGE)	007-5500-x	007-5500-x	\$40	\$40	\$46
Spoiler, 1pc, 1/8" polycarbonate, up to 8"	000-6701	000-6701	\$40	\$40	N/A
Wheel Flares, 3pc, high-impact plastic, left side (ALSO AVAILABLE IN ORANGE)	007-261-xL	007-261-xL	\$54	\$54	\$67
Wheel Flares, 3pc, high-impact plastic, right side (ALSO AVAILABLE IN ORANGE)	007-261-xR	007-261-xR	\$54	\$54	\$67
Hood Scoop, composite	020-3330-x	020-3330-x	\$85	\$98	N/A
Window, Rear, flat, oversized, mar-resistant coated, 0.093"	020-6105-1	020-6105-1	\$125	\$125	N/A
Windows, Quarter, mar-resistant coated, 0.093", pair	022-6505B	025-6505B	\$109	\$109	N/A
Windshield, molded, mar-resistant coated, 1/8"	020-6325-2B	020-6325-2B	\$243	\$243	N/A
COMPLETE BODY PACKAGE PRICE	022-132-x	025-132-x	\$2,554	\$2,686	

*All windows are precut to fit, beveled & drilled, with black-out border unless otherwise specified.

TO ENHANCE YOUR BODY PACKAGE, CHOOSE FROM THE OPTIONS BELOW:

BODY PACKAGE OPTIONS & UPGRADES (ADD OR SUBTRACT TO PACKAGE PRICE ABOVE FOR TOTAL)			+/- PKG PRICE
Window, Rear, molded, oversized, mar-resistant coated, 0.093"	020-6115-1	\$152	\$27
Spoiler, 1-piece .080" aluminum, up to 8"	000-6702	\$40	\$0



» FOR INDIVIDUAL BODY PANEL DIMENSIONS VISIT FIVESTARBODIES.COM

PAVEMENT MODIFIED

FEATURED BODY ACCESSORIES



PREMIUM AVEX STYLE RIVETS:

- » Five Star Premium Rivets are known as the best quality on the market
- » Super-tight grip and won't spin out while drilling!
- » Grip range of up to 3/16" for 1/8" rivets and up to 1/2" for 3/16" rivets
- » For more details & ordering info page 126

CHASSIS CLAMPS:

- » Universal mount fits anywhere bracing is needed
- » Eliminate the need for welding or use of hose clamps when mounting body braces
- » Threaded flange / no nut required
- » Three options to fit different roll bar tubing thickness
- » For more details & ordering info page 145



WIDE ANGLE RACING MIRROR:

- » This convex glass mirror gives you the best view of your competition!
- » All black frame with black anodized machined aluminum brackets
- » For more details & ordering info page 146

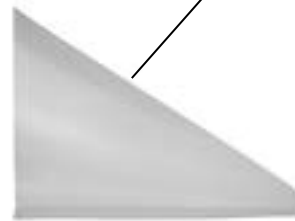

POLYCARBONATE DOOR VENT WINDOWS:

- » Molded vent windows give cars a proven performance gain in the wind tunnel over flat unmolded windows
- » Oversized and cut-to-fit options made of molded, mar-resistant coated clear .093" polycarbonate
- » For more details & ordering info page 146

» GO TO PAGES 124-147 TO SEE ALL ACCESSORIES FOR THIS BODY STYLE

PRICING SUBJECT TO CHANGE WITHOUT NOTICE



OUTLAW LATE MODEL

DESIGNED TO MAXIMIZE DOWNFORCE

Our Outlaw Late Model Nose made its way to victory lane multiple times in 2023!

Racers say the downforce, ease of installation, & our proprietary blend of plastic makes this Outlaw Nose is far superior to other options on the market!





OUTLAW NOSE FEATURES

- » 1-piece center can be cut for nose width adjustability
- » Aggressive aero styling for maximum downforce
- » Nose screen recess molded into the center
- » Fenders allow for maximum tire clearance
- » Fits flat to hood & rear fender area
- » Height adjustable lower fender
- » 3-1/2" wide built-in valance
- » Nose and fenders available in 5 colors



OUTLAW LATE MODEL

BODY PANELS & OPTIONS

OUTLAW NOSE COMBO KIT

-W -B -CB -R -G

Nose, high-impact plastic (VINYL GRAPHIC KIT INCLUDED)	22001-41051-X	\$65
Fender, upper, high-impact plastic, left	22001-23251-XL	\$87
Fender, upper, high-impact plastic, right	22001-23251-XR	\$87
Fender, lower, high-impact plastic, left	22001-23351-XL	\$30
Fender, lower, high-impact plastic, right	22001-23351-XR	\$30
NOSE COMBO KIT PRICE		\$299

COMMON BODY PANELS & WINDOWS

-W -B

-CB -R -G

-FG -FO -FR -FY

Nose Support, Lower, high-impact plastic	22001-42351	\$146	N/A	N/A
Nose Filler Panel, high-impact plastic	32000-35851-x	\$128	\$128	N/A
Nose Screen, 3/16" spacing	22001-46333	\$50	N/A	N/A
Nose Screen, black, 3/16" spacing	22001-46333B	\$55	N/A	N/A
Rocker Panel, high-impact plastic (3 NEEDED FOR COMPLETE INSTALL)	007-5500-X	\$40	\$40	\$46
Roof Option #1 (CHOOSE STANDARD COMPOSITE OR ADVANCED LIGHTWEIGHT COMPOSITE)				
Roof, composite	22001-51211-x	\$295	N/A	N/A
Roof, advanced lightweight composite	22001-51212-x	\$495	N/A	N/A
Roof Option #2 (WORKS WITH SAIL PANELS)				
Roof, Pavement Modified, composite	022-5102-x	\$523	\$560	N/A
Sail Panel, composite, left/right	022-280-XLorR	\$85 ea	\$96 ea	N/A
Window, Rear, .093", flat, mar-resistant coated, oversize	020-6105-1	\$125	\$125	N/A
Window, Quarter, Camaro, .093", mar-resistant coated, pre-cut to fit, pair	022-6505B	\$109	\$109	N/A
Window, Front, 1/8", molded, mar-resistant coated, pre-cut to fit	020-6325-2B	\$243	\$243	N/A

*ALL WINDOWS ARE PRECUT TO FIT, BEVELED & DRILLED, WITH BLACK-OUT BORDER UNLESS OTHERWISE SPECIFIED.

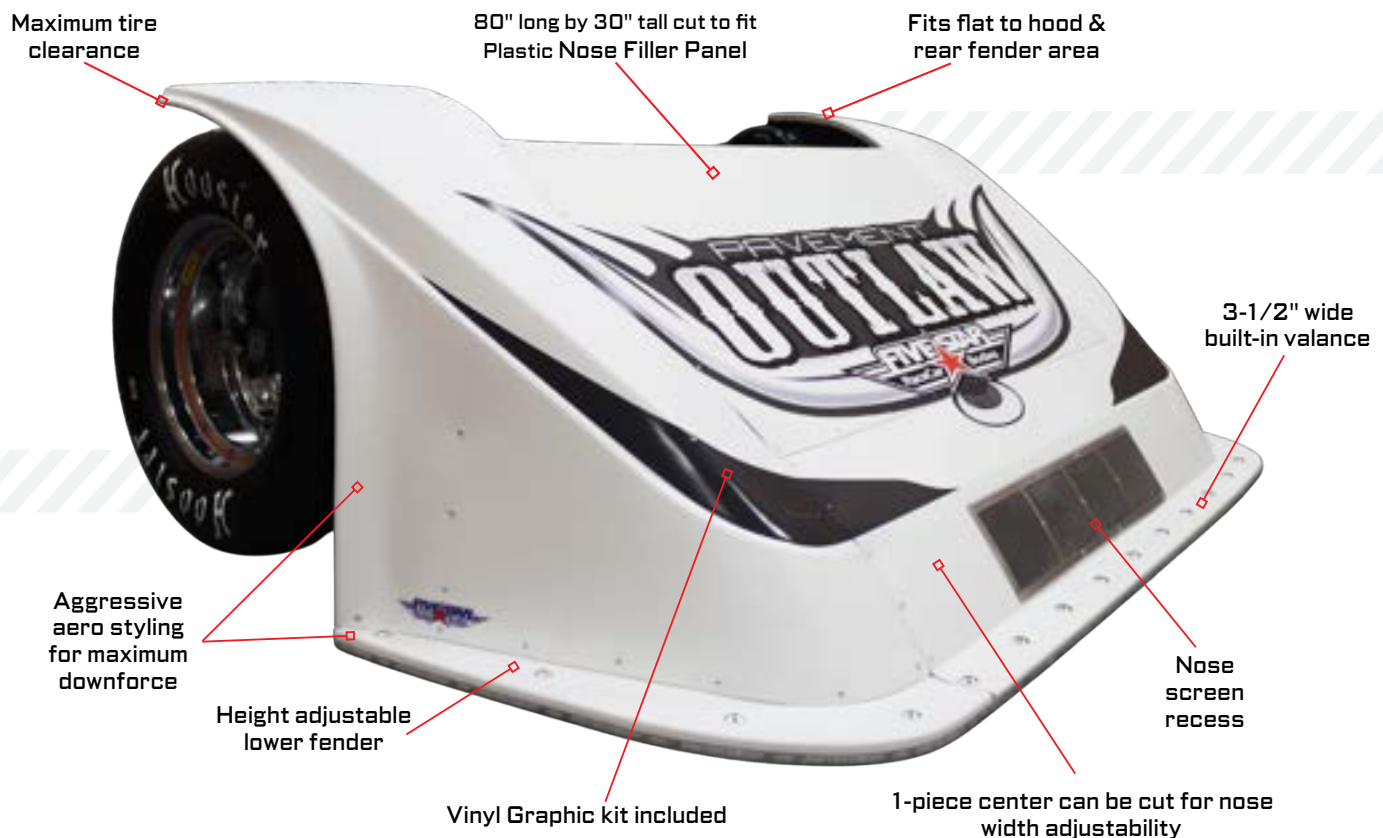

OUTLAW LATE MODEL

FEATURED BODY ACCESSORIES

PLASTIC NOSE FILLER PANEL:

- » 80" long by 30" tall
- » Flat high-impact plastic sheet deflects debris and resists chipping, denting, and bending.
- » Outperforms traditional aluminum panels in every way, this panel does not dent
- » See ordering info page 60

COMPOSITE ROOF: *NEW!*

- » Strong! Holds up to high speeds with minimal bracing
- » Two options: Standard Composite and Advanced lightweight composite made with Flame Retardant resin for added driver safety
- » See ordering info page 60

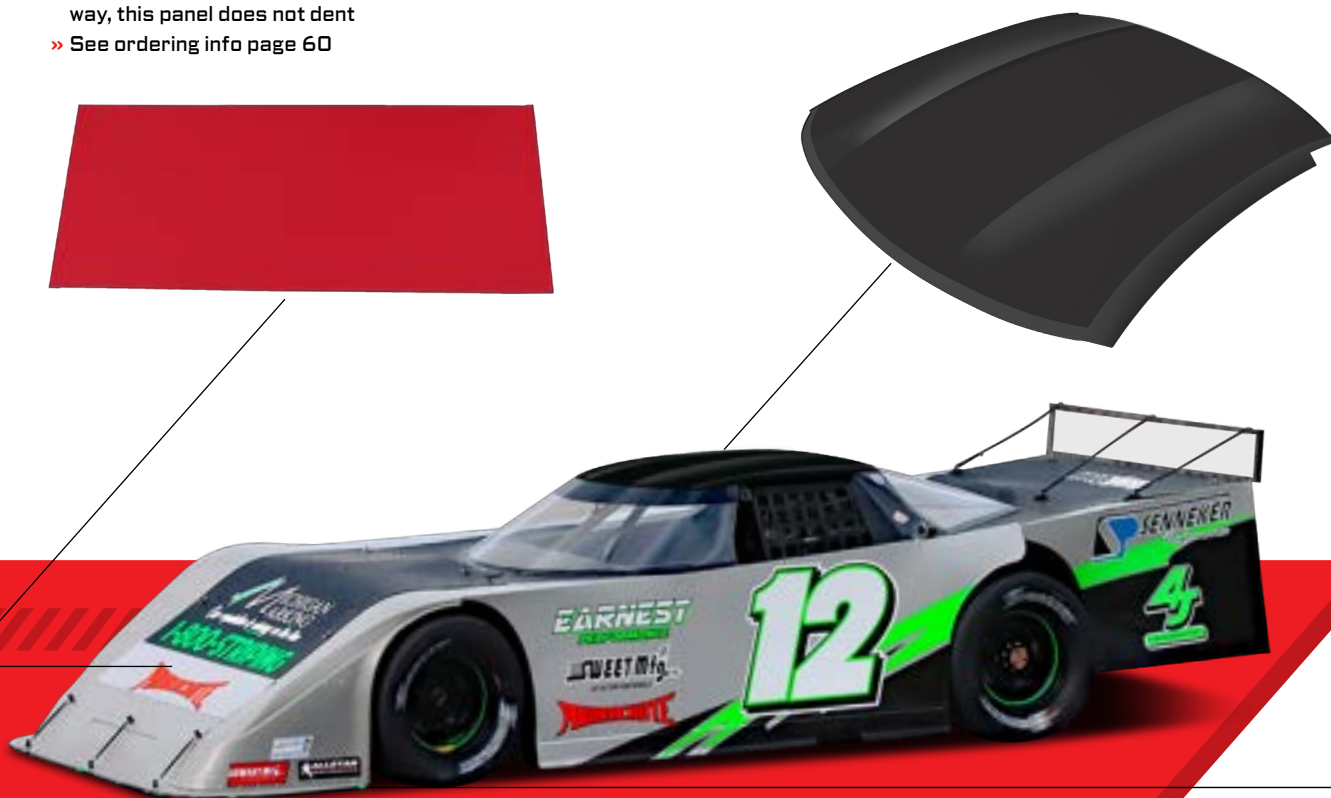

LOWER NOSE SUPPORT:

- » Add another layer of support with this lightweight, durable polyethylene plastic valance support
- » This lightweight, durable plastic nose support is .352" thick and adjusts from 86" to 96" long & can be trimmed to fit
- » See ordering info page 60



UNIVERSAL BODY MOUNTING KIT:

- » Universal fit that can be used anywhere on a race car
- » Plastic kit features Black Delrin washers that withstand repeated impact and stress
- » For more details & ordering info page 127

» GO TO PAGES 124-147 TO SEE ALL ACCESSORIES FOR THIS BODY STYLE

PRICING SUBJECT TO CHANGE WITHOUT NOTICE



NORTH AMERICAN SPORTSMAN

THE SUPERIOR DESIGN FOR SPORTSMAN RACING

This is the spec body for the NASCAR Mexico Series and is the top choice among competitors seeking cutting-edge performance. This body is a hassle free solution for any racer, setting a new standard for durability & aerodynamics in the sportsman racing.





- » All panels have consistent & repeatable fit for effortless installation & replacement
- » Panels have mounting flanges & locating tabs
- » Minimal trimming required
- » Universally designed for most sportsman divisions across North America
- » Common body has 3 nose options for brand identity
- » Two-piece greenhouse includes a built-in cowl and deck lid filler
- » Designed for metric style chassis
- » Available in 2 colors



NORTH AMERICAN SPORTSMAN

BODY PANELS & OPTIONS

HOW TO ORDER YOUR BODY IN 3 QUICK & EASY STEPS

» 1. SELECT BODY PACKAGE » 2. SELECT PANEL COLOR » 3. SELECT NOSE MAKE

RE-SKIN BODY PACKAGE

-W -B

Bumper Cover, Rear, high-impact plastic	12001-45051-x	\$152
Door, aluminum, left	12001-21033-xL	\$112
Door, aluminum, right	12001-21033-xR	\$112
Fender, high-impact plastic, left	11002-23051-xL	\$150
Fender, high-impact plastic, right	13002-23051-xR	\$150
Nose, high-impact plastic (SPECIFY MAKE: CAMARO-20132; MUSTANG-20321; CAMRY-20712)	20xxx-41051-x	\$177
Quarter Panel, high-impact plastic, left	12001-27351-xL	\$134
Quarter Panel, high-impact plastic, right	12001-27351-xR	\$134
Rocker Panel, fits either side, high-impact plastic (2 REQUIRED)	000-5501P-x	\$33
Rocker Panel, fits either side, high-impact plastic (ENTERED TWICE TO SHOW PACKAGE PRICE)	000-5501P-x	\$33
RE-SKIN BODY PACKAGE PRICE	12001-10000-x	\$1,187

COMPLETE BODY PACKAGE (RE-SKIN COMPONENTS PLUS ITEMS BELOW)

-W -B

Cowl Air Insert, Ultraglass composite	661-5100A-B	\$68
Deck Lid Hold-Down Strip, aluminum	XM 000-310H-x	\$10
Deck Lid, aluminum	661-310A-x	\$76
Greenhouse, Front, composite	12001-51311-x	\$492
Greenhouse, Rear, composite	12001-51511-x	\$520
Hood, flat, composite	12001-33011-x	\$320
Spoiler, Complete, 4pc, 3/16" poly blades, unpainted brackets, 5" x 60", 70°	11002-47357	\$129
Window, Quarter, coated, black-out border, 0.093", left	12001-65153-L	\$55
Window, Quarter, coated, black-out border, 0.093", right	12001-65153-R	\$55
Window, Rear, uncoated, 0.093"	12001-61151	\$201
Windshield, mar-resistant coated, 1/8"	12001-63253	\$357
COMPLETE BODY PACKAGE PRICE	12001-10600-x	\$3,470

*ALL WINDOWS ARE PRECUT TO FIT, BEVELED & DRILLED, WITH BLACK-OUT BORDER UNLESS OTHERWISE SPECIFIED.

NASCAR MEXICO SERIES SPECIFIC BODY PANELS

-W -B

Greenhouse, Front, long, composite	12001-51111-x	\$492
Door, aluminum, long, left	12001-21133-xL	\$112
Door, aluminum, long, right	12001-21133-xR	\$112

TO ENHANCE YOUR BODY PACKAGE, CHOOSE FROM THE OPTIONS BELOW:

BODY PACKAGE OPTIONS & UPGRADES (ADD OR SUBTRACT TO PACKAGE PRICE ABOVE FOR TOTAL)

-W -B +/- PKG PRICE

Hood, scooped, composite				20002-33311-X	\$320	\$0
Spoilers: 60" wide	5" (90°)	5" (70°)	6-1/2" (90°)	6-1/2" (70°)		
Complete, aluminum	11002-47359	11002-47357	11002-47369	11002-47367	\$129	\$0
Complete, aluminum, black	11002-47359-B	11002-47357-B	11002-47369-B	11002-47367-B	\$139	+\$10

NORTH AMERICAN SPORTSMAN

BODY MOUNTING KIT

» EVERYTHING YOU NEED FOR THAT CLEAN & PROFESSIONAL INSTALL!

COMPLETE BODY MOUNTING KIT SAVE \$\$ WHEN PURCHASING COMPLETE KIT VERSUS INDIVIDUAL COMPONENTS!

Adjustable Body Braces (X3 @ \$35EA)	807-3	\$105
Aluminum Nose Side Braces, pair	11002-75333	\$14
Door Vent Windows, pair	000-6202	\$35
Front Bumper Mounting Kit	10001-72721	\$132
Front Bumper, 1-3/4", .065" steel	20002-71182	\$48
Graphics, Nose ID Kit (SPECIFY MAKE BELOW)	20xx2-44141	\$37
Graphics, Bumper Cover ID Kit (SPECIFY MAKE BELOW)	11xx2-44542	\$36
Hood Pin Bracket, 3/4" steel (4 PINS REQUIRED)	20002-34331	\$35
Hood Pin Kit, 3/8" pins (X2 @ \$15EA) SPECIFY COLOR: -B -CB -R	10001-34033-x	\$30
Nose Screen, stainless, 3/16"	660-4111	\$50
Rear Bumper Mounting Kit	802-2S	\$49
Rear Bumper, 1-3/4", .065" steel	11002-71682	\$48
Rear Deck Mounting Kit	660-450-RDK	\$87
Rear Window Brace Kit (3PC)	12001-76133	\$76
Universal Body Mounting Kit, plastic	00001-72651	\$29
Wear Strips, plastic SPECIFY COLOR: -W -B -CB -OR -R -Y -FG -FO -FR -FY	20002-41551-x	\$38
Window Installation Kit	805	\$23
Windshield Brace Kit (3PC)	12001-76333	\$76
COMPLETE KIT PRICE WITH 10% DISCOUNT	12001-72520	\$853.20

BODY MOUNTING KIT OPTIONS & UPGRADES (ADD GREEN \$ TO PACKAGE PRICE ABOVE FOR TOTAL)

Nose Screen, 1/4" spacing	660-4112	\$50	\$0	Nose Screen, black aluminum frame, 3/16"	10001-46333B	\$55	+\$5
Nose Screen, black, 1/4" spacing	660-4112-B	\$55	+\$5	Nose Screen, black aluminum frame, 1/4"	10001-46433B	\$55	+\$5
Nose Screen, black, 3/16" spacing	660-4111-B	\$55	+\$5	Universal Body Mounting Kit, aluminum	000-400K	\$49	+\$20

VINYL NOSE & BUMPER COVER GRAPHIC ID KITS FOR A REALISTIC OEM LOOK!

PRINTED ON OUTDOOR DURABLE HIGH-TACK VINYL • GLOSSY LAMINATED SURFACE PROVIDES EXCELLENT PROTECTION



CHEVROLET CAMARO

Nose ID Kit	20132-44141	\$37
Bumper Cover ID Kit	11132-44542	\$36

FORD MUSTANG

Nose ID Kit	20321-44141	\$37
Bumper Cover ID Kit	11322-44541	\$36

TOYOTA CAMRY

Nose ID Kit	20712-44141	\$37
Bumper Cover ID Kit	11712-44541	\$36

» GO TO PAGES 124-147 TO SEE ALL COMPONENTS & ACCESSORIES FOR THIS BODY

PRICING SUBJECT TO CHANGE WITHOUT NOTICE

NORTH AMERICAN SPORTSMAN

FEATURED BODY ACCESSORIES

HOOD PIN KITS:

- » 2 pack kits includes the following:
2 newly improved lightweight anodized and gun-drilled aluminum pins (half the weight of standard), 2 aluminum scuff plates, 2 flip-over steel clips, 4 jam nuts
- » For more details & ordering info page 129

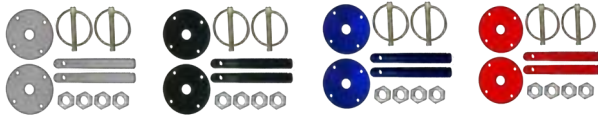

PREMIUM AVEX STYLE RIVETS:

- » Five Star Premium Rivets are known as the best quality on the market
- » Super-tight grip and won't spin out while drilling!
- » Grip range of up to 3/16" for 1/8" rivets and up to 1/2" for 3/16" rivets
- » For more details & ordering info page 126

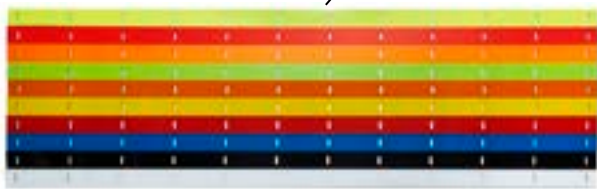

HIGH-IMPACT PLASTIC WEAR STRIPS:

- » Height adjustable to seal the nose to the track to optimize aero and protection from wear
- » CNC-machined from Five Star's exclusive durable plastic
- » For more details & ordering info page 127



POLYCARBONATE RUB RAIL:

- » Protect your vinyl without hiding it!
- » Attach to side of body to eliminate tire marks on fenders, doors, and quarter panels
- » For more details & ordering info page 139

» GO TO PAGES 124-147 TO SEE ALL ACCESSORIES FOR THIS BODY STYLE

NORTH AMERICAN SPORTSMAN

BODY DIMENSIONS

FIVE STAR BODIES ARE DESIGNED TO MAINTAIN A PRECISE FIT WITH OPTIMIZED AERODYNAMICS!

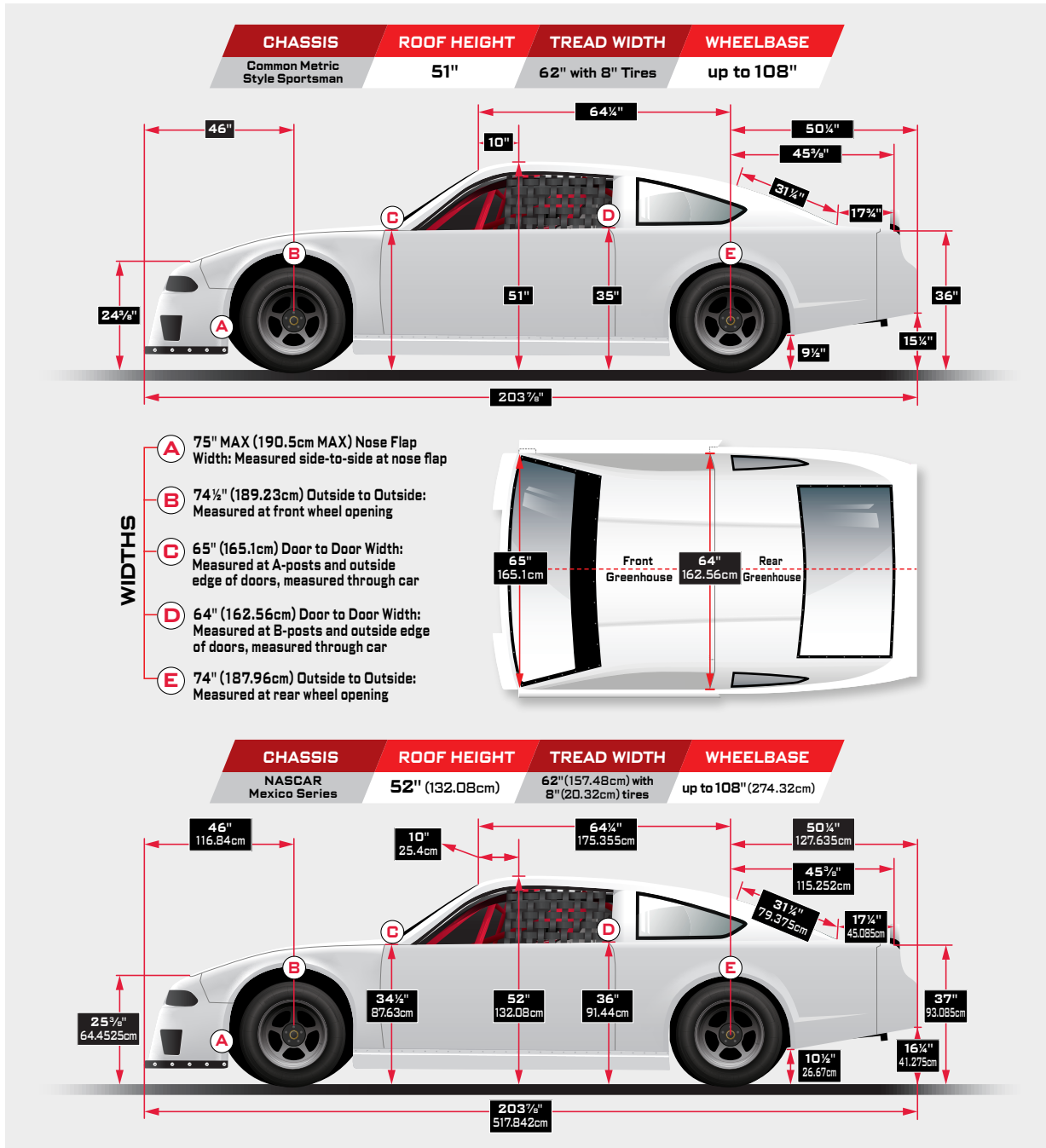

BODY PANEL

DIMENSIONS

» FOR INDIVIDUAL BODY PANEL DIMENSIONS, VISIT FIVESTARBODIES.COM

NORTH AMERICAN SPORTSMAN

BODY MOUNTING FIXTURES & TEMPLATES

MOUNT YOUR BODY FAST & EASY TO MAXIMIZE PERFORMANCE & TO PASS TECH INSPECTION!



ROOF LOCATING FIXTURE

- » THE FAST & EASY WAY TO MOUNT YOUR COMPLETE BODY WITHOUT THE CHASSIS UNDERNEATH
- » This time-saving device has adjustable quarter panel arms and makes locating the roof on your chassis a simple process
- » Allows exact fit for wheel opening locations, body dimensions, and inspection templates to fit series specs
- » Pre-fits from the cowl to the bumper cover, then can be lifted easily on top of the chassis for final fit
- » Comes in a black powder-coat finish and includes roof brackets, door height blocks and assembly instructions

Roof Locating Fixture (includes Roof Brackets & Door Height Blocks)	809P	\$875
Replacement Roof Brackets	12001-72231	\$71
Replacement Door Height Blocks, 7" tall	809-HB	\$38

NORTH AMERICAN SPORTSMAN TEMPLATES ENSURE A CORRECT FIT FOR OPTIMUM AERODYNAMICS

- » Complete template set ensures body is installed correctly
- » Complete sets include: Body Centerline, Fenders, Nose Centerline, Nose Side-to-Side, Front & Rear Roof Side-to-Side
- » Nose and fender templates are specific to model
- » Common templates can check all models
- » Master sets available with templates for all models

Template, Complete Set, wood, Chevrolet	12131-82091	\$331
Template, Complete Set, wood, Ford	12321-82091	\$331
Template, Complete Set, wood, Toyota	12712-82091	\$331

BODY PANEL MOUNTING TOOLS



FIVE STAR PREMIUM AVEX STYLE RIVETS

- » The best quality on the market!
- » Five Star Rivets have a super-tight grip, won't spin out while drilling and pull much tighter than other, cheaper rivets.
- » For more details & ordering info page 126



CLECO KIT & PLIERS:

- » Cleco pliers and Cleco fasteners ensure perfect alignment every time
- » Clecos can be easily inserted with the cleco pliers to temporarily hold panels during the body mounting process
- » For more details & ordering info page 141

» FOR MORE BODY MOUNTING TOOLS, GO TO PAGES 124-147

OTHER BODY STYLES

EXCLUSIVELY ON OUR WEBSITE

» VISIT FIVESTARBODIES.COM FOR ORDERING INFO!



FIBERGLASS SPORTSMAN



STRAIGHT UP METAL



S2 SPORTSMAN



MINISTOCK MUSTANG



OFF ROAD TRUCK



TROPHY KART TRUCK



» KEEP UP TO SPEED, FOLLOW US ON SOCIAL MEDIA!



PRICING SUBJECT TO CHANGE WITHOUT NOTICE

ABC LMSC TRUCK RAY MODIFIED OUTLAW LATE MODEL SPORTSMAN STREET STOCK M33 LATE MODEL M33 MODIFIED DIRT GRAND NATL T42 PRO STOCK/MOD FUNNY CAR WINDOWS ACCESSORIES



STREET STOCK

THE MOST VERSATILE BODY ON THE MARKET

The Street Stock Body showcases a timeless design that has proven its versatility over the years, making it a long-lasting, reliable top choice in the market at short tracks around the country.



- » Replace old, hard-to-find junkyard panels economically with our complete line of body panels, components, and accessories
- » '88 Monte Carlo panels designed to ensure stock appearance
- » Upgrade to a modern look with Camaro & Mustang nose, fenders, & hood options
- » Great for both dirt & pavement racing
- » Excellent fit, easy to install
- » See color availability options for all body panels and components in ordering section



STREET STOCK

BODY PANELS & OPTIONS

THE MOST VERSATILE BODY ON THE MARKET

» CHOOSE BETWEEN THE CLASSIC '88 MONTE CARLO OR THE MODERN STYLE LOOK

BODY STYLE OPTIONS

'88 Monte Carlo Style Body Panels		-W	-B	-CB	-OR	-R	-Y	-G
Bumper Cover, high-impact plastic	021-450-x							
Bumper Cover ID Kit	021-450-ID							
Nose, high-impact plastic (SPECIFY MAKE: CLASSIC-600 (N/A ORANGE OR YELLOW); MD3-021)	xxx-410-x							
Nose ID Kit (SPECIFY MAKE: CLASSIC-600; MD3-021)	xxx-410-ID							
Hood, composite, flat	601-3301-W							
Hood, composite, scooped	601-3303-W							
Modern Style Body Panels		-W	-B	-CB	-R			
Nose, high-impact plastic (SPECIFY MAKE: CAMARO-20132; MUSTANG-20321; CAMRY-20712)	2xxx-41051-x							
Nose ID Kit (SPECIFY MAKE: CAMARO-20132; MUSTANG-20321; CAMRY-20712)	2xxx-44141							
Fender, half, high-impact plastic, left or right	20002-23051-xLorR							
Fender, full, high-impact plastic, left	11002-23051-xL							
Fender, full, high-impact plastic, right	13002-23051-xR							
Hood, composite, scooped	20002-33311-x							

COMMON BODY PANEL OPTIONS

		-W	-B
Fender, Factory Outer Skin, steel, left	601-24SL	N/A	\$135
Fender, Factory Outer Skin, steel, right	601-24SR	N/A	\$135
Fender, Lower, aluminum, left or right	601-23A-WLorR	\$88	N/A
Fender, Lower, steel, left or right	601-23S-WLorR	\$88	N/A
Quarter Panel, Factory Outer Skin, steel, left or right	601-28SLorR	N/A	\$259
Quarter Panel, Lower, steel, left or right	601-27S-WLorR	\$105	N/A
Quarter Panel, Lower, aluminum, left or right	601-27A-WLorR	\$105	N/A
Door, aluminum, left or right	601-21A-WLorR	\$145	N/A
Door, aluminum, extra-long, left or right	601-211A-WLorR	\$145	N/A
Door, steel, left or right	601-21S-WLorR	\$145	N/A
Door, steel, left or right, IMCA-legal	601-22S-WLorR	\$145	N/A
Door, steel, extra-long, left or right	601-211S-WLorR	\$145	N/A
Deck Lid, aluminum	601-310A-W	\$60	N/A
Deck Lid, steel	601-310S-W	\$60	N/A
Deck Lid Filler Panel, composite	601-3200-W	\$185	N/A
Deck Lid Filler Panel, steel	601-320S-W	\$99	N/A
Roof, front, composite (SEE PAGE 73 FOR DETAILS)	601-5112-W	\$338	N/A
Roof, rear, standard, composite (SEE PAGE 73 FOR DETAILS)	601-5102-W	\$186	N/A
Roof, rear, long, composite (SEE PAGE 73 FOR DETAILS)	601-5104-W	\$186	N/A
2-piece Spoiler, aluminum	601-6702	\$48	\$48
Windshield, blank, coated, 32" X 72" X 1/8"	000-6301	\$132	\$132
Windshield Black-out Kit	600-6390	\$17	\$17

WINDOW OPTIONS

For the 2-Piece Composite Roof			
Windshield, flat, coated, 1/8"	601-6303-2B	\$264	N/A
Windows, Quarter, flat, uncoated, pair, .093"	601-6502-2B	\$58	N/A
Window, Rear, uncoated, .093"	601-6101-2	\$76	N/A
For the Factory Stock Roof			
Windshield, flat, coated, 1/8", no black-out	600-6303	\$233	\$233
Windows, Quarter, flat, uncoated, pair, .093"	600-6502	\$32	\$32
Window, Rear, flat, uncoated, .093"	600-6101	\$61	\$61
Windows Rear, coated, Aero Coupe, 1/8"	604-6125-A	\$371	\$371

*ALL WINDOWS ARE PRECUT TO FIT, BEVELED & DRILLED, WITH BLACK-OUT BORDER UNLESS OTHERWISE SPECIFIED.

2-PIECE COMPOSITE ROOF

- » Made from Standard Fiberglass Composite (lighter than factory steel)
- » Exact factory OEM shape with attached a-posts & cowl panel
- » Front roof has full molded in windshield bed
- » Rear roof available in 2 different lengths:
 - » **Standard** - fits up to a 108" wheelbase
 - » **Extra-long** - fits up to a 112" wheelbase (uses extra-long doors)

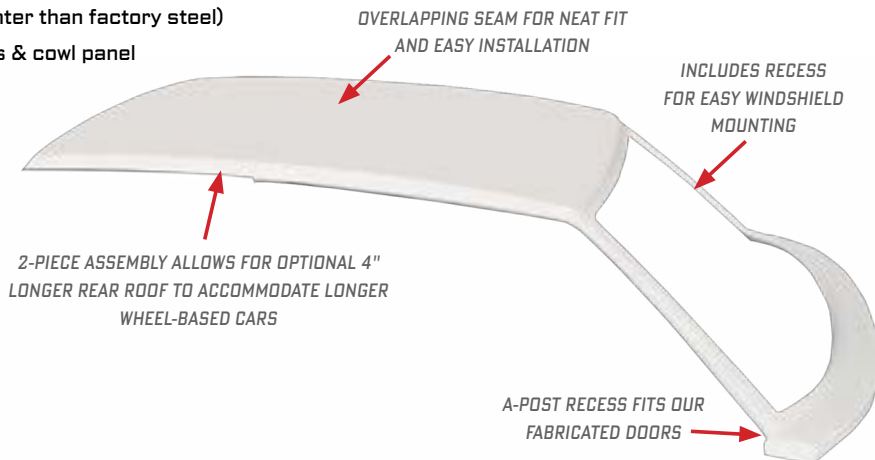

STREET STOCK DIMENSIONS

Make sure your body aligns accurately to maximize its performance and pass tech inspection successfully!
Modern Style Nose Body dimensions match up with '88 Monte Style Nose Body dimensions

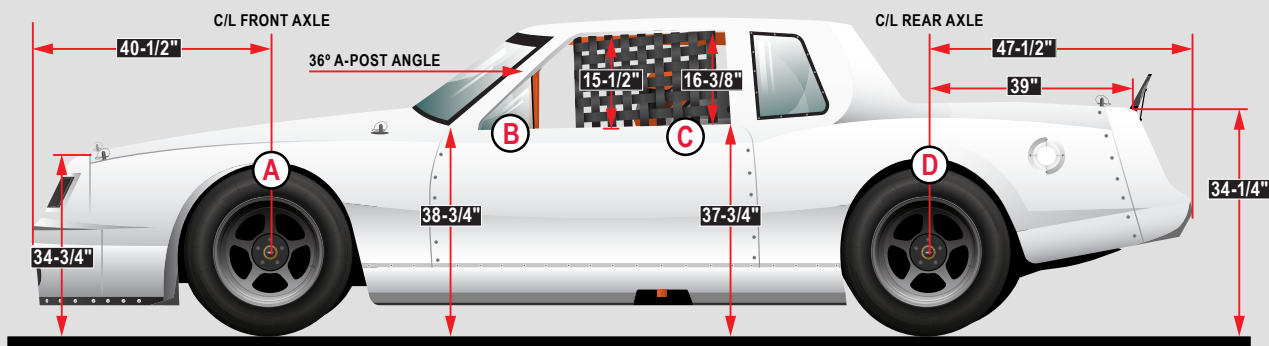

- WIDTHS**
- A** 71"
Outside to Outside:
Measured at front wheel opening
 - B** 65"
Door to Door Width: Measured at
A-posts and outside edge of doors,
measured through car
 - C** 65-1/2"
Door to Door Width: Measured at
B-posts and outside edge of
doors, measured through car
 - D** 65-1/2"
Outside to Outside:
Measured at rear wheel opening

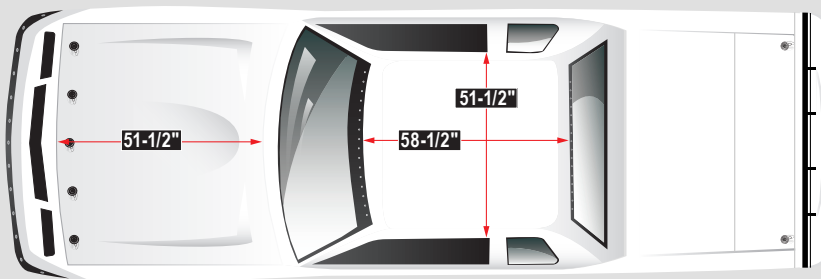

CHASSIS	ROOF HEIGHT	TREAD WIDTH	WHEELBASE
METRIC	52"	63" MAX	108"



» FOR INDIVIDUAL BODY PANEL DIMENSIONS, VISIT FIVESTARBODIES.COM

» FOR BODY MOUNTING TOOLS, GO TO PAGES 124-147

STREET STOCK

FEATURED BODY ACCESSORIES

AIR FILTER DEFLECTORS:

- » Lightweight, high-impact molded plastic deflectors have a sleek aerodynamic design that provides maximum air filter protection
- » Three options to choose from, 3", 5", and 6" height
- » For more details & ordering info page 83



PLASTIC ROCKER PANEL:

- » Aerodynamically designed for the best side force
- » They are easy to mount & add structural integrity to side body panels
- » For more details & ordering info page 84

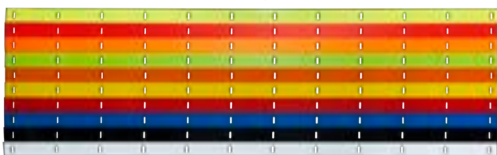

HIGH-IMPACT PLASTIC WEAR STRIPS:

- » Height adjustable to seal the nose to the track to optimize aero and protection from wear
- » CNC-machined from Five Star's exclusive durable plastic
- » For more details & ordering info page 127

PREMIUM AVEX STYLE RIVETS:

- » Five Star Premium Rivets are known as the best quality on the market
- » Super-tight grip and won't spin out while drilling!
- » Grip range of up to 3/16" for 1/8" rivets and up to 1/2" for 3/16" rivets
- » For more details & ordering info page 126

» GO TO PAGES 124-147 TO SEE ALL ACCESSORIES FOR THIS BODY STYLE

STREET STOCK

GRAPHIC KITS & NOSE SCREENS

VINYL NOSE & BUMPER COVER GRAPHIC ID KITS FOR A REALISTIC OEM LOOK!

PRINTED ON OUTDOOR DURABLE HIGH-TACK VINYL • GLOSSY LAMINATED SURFACE PROVIDES EXCELLENT PROTECTION



CHEVROLET CAMARO

Nose ID Kit 20132-44141 \$37



FORD MUSTANG

Nose ID Kit 20321-44141 \$37



TOYOTA CAMRY

Nose ID Kit 20712-44141 \$37



CLASSIC '81-'88 MONTE CARLO

Nose ID Kit 600-410-ID \$37



MD3 '81-'88 MONTE CARLO

Nose ID Kit 021-410-ID \$37



'81-'88 MONTE CARLO

Bumper Cover ID Kit 021-450-ID \$36

NEW!

ACHIEVE MAXIMUM VINYL ADHESION BY USING MD3 ADHESION PROMOTER. DETAILS AND ORDERING INFORMATION ON PAGE 147!



PROTECT YOUR RADIATOR FROM DEBRIS PENETRATION WITH NOSE SCREENS!

UNPAINTED



BLACK POWDER-COATED

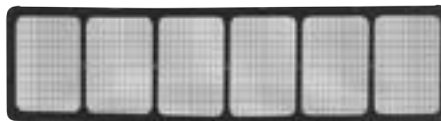

BLACK ALUMINUM FRAME

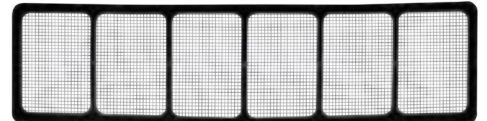

ALUMINUM NOSE SCREENS

- » Frame is laser cut from lightweight aluminum
- » Screen is high strength stainless steel (3/16" mesh is crimped, 1/4" is welded)
- » Available options: black aluminum frame, unpainted, or with durable satin black powder-coated finish

PN	NOSE SCREEN DESCRIPTION	WIDTH (Top)	WIDTH (Bottom)	HEIGHT	MESH	
021-4131	MD3 81-88 Monte Carlo, Upper	30-3/4"	29"	5-1/2"	3/16"	\$50
021-4131-8	MD3 81-88 Monte Carlo, Upper	30-3/4"	29"	5-1/2"	3/16"	\$55
021-4132	MD3 81-88 Monte Carlo, Upper	30-3/4"	29"	5-1/2"	1/4"	\$50
600-4111	Classic 81-88 Monte Carlo, Lower	28-1/4"	28-1/4"	5-3/4"	3/16"	\$50
600-4112	Classic 81-88 Monte Carlo, Lower	28-1/4"	28-1/4"	5-3/4"	1/4"	\$50
600-4131	Classic 81-88 Monte Carlo, Upper	30"	30"	6"	3/16"	\$50
600-4132	Classic 81-88 Monte Carlo, Upper	30"	30"	6"	1/4"	\$50

PRICING SUBJECT TO CHANGE WITHOUT NOTICE

ABC LMSC TRUCK RAY MODIFIED OUTLAW LATE MODEL SPORTSMAN STREET STOCK MD3 LATE MODEL MD3 MODIFIED DIRT GRAND NATL TAZ PRO STOCK/MOD FUNNY CAR WINDOWS ACCESSORIES



DIRT LATE MODEL

THE #1 CHOICE FOR DIRT RACERS

All panels are designed with great-style, provide maximum downforce, and are proven to be the most durable, cost-effective products on the market!





- » Molded plastic panels provide unmatched flexibility and durability!
- » Advanced lightweight composite panels are very close to a carbon fiber blend in strength and weight
- » Premium plastic materials available exclusively and only in MD3 products
- » Achieve maximum vinyl adhesion by using MD3 Adhesion Promoter
- » See color availability options for all body panels and components in ordering section



DIRT LATE MODEL

EVOLUTION 2 NOSE COMBO KIT

EVOLUTION 2 NOSE COMBO KIT

-W -B -CB -G -OR -R -Y -FG -FO -FR -FY

Nose, 2-piece, high-impact plastic	32004-41051-x	\$189	N/A
Nose Lower Aero Valance, high-impact plastic	32004-41751-x	\$72	\$87
Fender, upper, left, high-impact plastic	32004-23251-xL	\$86	N/A
Fender, upper, right, high-impact plastic	32004-23251-xR	\$86	N/A
Fender, lower, left, high-impact plastic	32004-23351-xL	\$37	\$56
Fender, lower, right, high-impact plastic	32004-23351-xR	\$37	\$56
NOSE COMBO KIT PRICE		32004-43554-x	\$507
			\$560

TO ADD A REALISTIC OEM LOOK TO YOUR NOSE, SEE VINYL NOSE GRAPHIC ID KITS | PAGE 85



2-PIECE UPPER & LOWER FENDERS ALLOWS FOR EXACT GROUND HEIGHT ADJUSTMENT

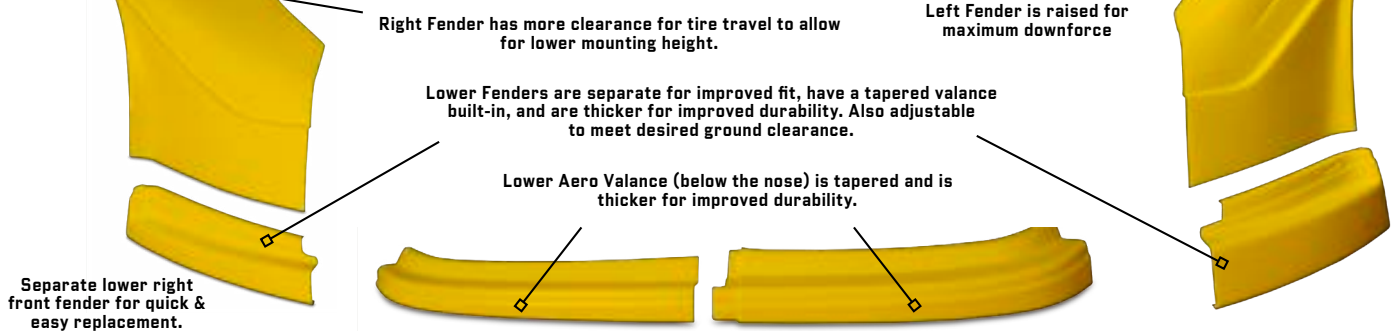

COMPLETE COMMON BODY PACKAGE NOSE COMBO KIT PLUS ITEMS BELOW

-W -B -CB -G -OR -R -Y -FG -FO -FR -FY

Door, high-impact plastic, right (N/A IN GRAY)	32001-21051-xR	\$152	N/A
Hood, composite (N/A IN GRAY)	32003-33512-x	\$486	N/A
Nose Filler Panel, high-impact plastic	32000-35851-x	\$128	N/A
Quarter Panel, high-impact plastic, left (N/A IN GRAY)	32001-27351-xL	\$119	N/A
Quarter Panel, high-impact plastic, right (N/A IN GRAY)	32001-27351-xR	\$119	N/A
Roof, composite (N/A IN GRAY)	006-5101L-x	\$499	N/A
Roof Cap, plastic (N/A IN GRAY) (CARBON FIBER CF AVAILABLE FOR \$38)	006-500-x	\$35	\$35
Rocker Panel, fits either side, high-impact plastic (2 REQUIRED)	007-5500-x	\$40	\$46
Rocker Panel, fits either side, high-impact plastic (ENTERED TWICE TO SHOW PACKAGE PRICE)	007-5500-x	\$40	\$46
COMPLETE BODY PACKAGE PRICE		32004-10352-x	\$2,125
			\$2,190

DIRT LATE MODEL

EVOLUTION NOSE COMBO KIT

EVOLUTION NOSE COMBO KIT

-W -B -CB -G -OR -R -Y -FG -FO -FR -FY

Nose, 2-piece, high-impact plastic	32003-41051-X	\$189	N/A
Fender, left, high-impact plastic	32003-23051-XL	\$91	N/A
Fender, right, high-impact plastic	32003-24051-XR (FLAT) 32003-23051-XR (RAISED)	\$91	N/A
NOSE COMBO KIT PRICE		32003-43554-x	\$371
			N/A

TO ADD A REALISTIC OEM LOOK TO YOUR NOSE, SEE VINYL NOSE GRAPHIC ID KITS | PAGE 85



COMPLETE COMMON BODY PACKAGE NOSE COMBO KIT PLUS ITEMS BELOW

-W -B -CB -G -OR -R -Y -FG -FO -FR -FY

Door, high-impact plastic, right (N/A IN GRAY OR YELLOW)	32001-21051-xR	\$152	N/A
Hood, composite (N/A IN GRAY OR YELLOW)	32003-33512-x	\$486	N/A
Nose Filler Panel, high-impact plastic (N/A IN YELLOW)	32000-35851-x	\$128	N/A
Nose Aero Valance, lower, high-impact plastic (N/A IN YELLOW)	32003-41751-x	\$98	\$98
Quarter Panel, high-impact plastic, left (N/A IN GRAY OR YELLOW)	32001-27351-xL	\$119	N/A
Quarter Panel, high-impact plastic, right (N/A IN GRAY OR YELLOW)	32001-27351-xR	\$119	N/A
Roof, composite (N/A IN GRAY)	006-5101L-x	\$499	N/A
Roof Cap, plastic (N/A IN GRAY) (CARBON FIBER CF AVAILABLE FOR \$38)	006-500-x	\$35	\$35
Rocker Panel, fits either side, high-impact plastic (2 REQUIRED)	007-5500-x	\$40	\$46
Rocker Panel, fits either side, high-impact plastic (ENTERED TWICE TO SHOW PACKAGE PRICE)	007-5500-X	\$40	\$46
COMPLETE COMMON BODY PACKAGE PRICE		32003-10352-x	\$2,087
			\$2,099

PRICING SUBJECT TO CHANGE WITHOUT NOTICE

ABC LMSC TRUCK RAV/MODIFIED OUTLAW/LATE MODEL SPORTSMAN STREET STOCK M03 LATE MODEL M03 MODIFIED DIRT GRAND NATL TAZ PRO STOCK/MOD FUNNY CAR WINDOWS ACCESSORIES

DIRT LATE MODEL

BODY PANELS & COMPONENTS

FIVE STAR BODY PANELS ARE DESIGNED TO MAINTAIN PRECISE FIT WITH OPTIMIZED AERODYNAMICS!

OVERSIZED 80" X 30" PANEL IS TRIM-TO-FIT FOR YOUR CUSTOM APPLICATION

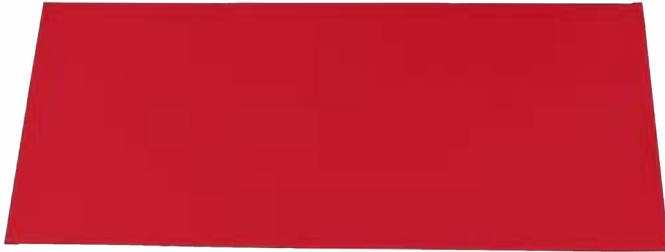

PLASTIC NOSE FILLER PANEL

- » Mounts between the nose, hood and fenders
- » Flat high-impact plastic sheet deflects debris and resists chipping, denting, bending
- » Outperforms traditional aluminum panels in every way, this panel does not dent!
- » Flame retardant material with high heat distortion temperature
- » Same weight per square foot as .040" aluminum!
- » Available in 5 colors **-W -B -CB -G -R**

Nose Filler Panel 32000-35851-X \$128



HOOD SCOOPS

- » Lightweight, molded high-impact plastic scoops are shaped for peak aero performance
- » Three options to choose from: 3" tall x 16" wide, 5" tall x 16" wide and the all new 5" tall x 18" wide
- » Raise the height of your Hood Scoop using a polycarbonate Hood Scoop Extension to protect your air filter!
- » Available in 4 colors including a carbon fiber look; appearance of carbon fiber, at a fraction of the cost.

		-W	-CB	-R	-CF
Hood Scoop, 3" tall x 16" wide, curved	040-4114-X	\$52	\$59		
Hood Scoop, 5" tall x 16" wide, curved	040-4116-X	\$52	\$59		
Hood Scoop, 5" tall x 18" wide, curved	040-4118-X	\$52	\$61		
Hood Scoop Extension, Tinted, 3"x16"	040-4117-TNT	\$41	N/A		
Hood Scoop Extension, Tinted, 3"x18"	040-4119-TNT	\$38	N/A		



3" Curved Scoop



5" Tall, 18" Wide Curved Scoop shown with Extension

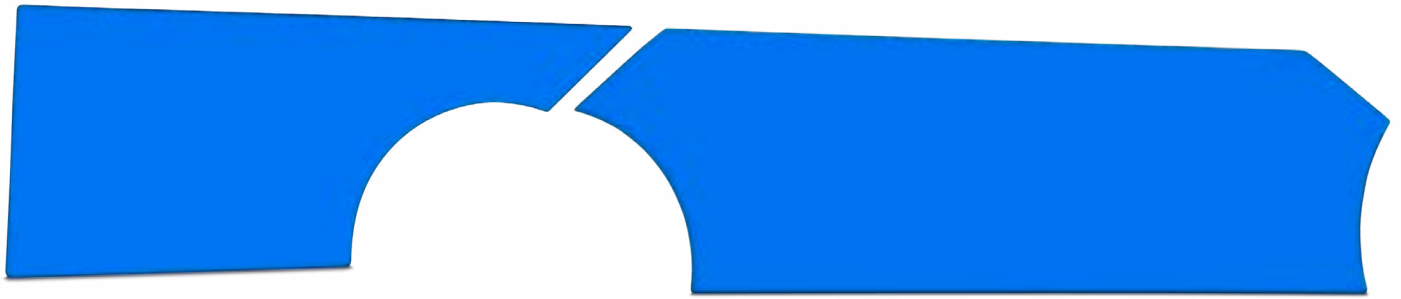

- » Molded high-impact plastic out performs aluminum in every way
- » Resists chipping, denting, & bending
- » Common design to fit most late model chassis
- » Meets all flame resistance test requirements

- » Molded flanges for added rigidity and easy installation
- » Approved for competition by all major national sanctioning series
- » Available in 5 colors **-W -B -CB -G -R**

PLASTIC QUARTER PANEL

Quarter Panel, right	32001-27351-xR	\$119
----------------------	----------------	-------

PLASTIC RIGHT SIDE DOOR

Door, right	32001-21051-xR	\$152
-------------	----------------	-------



MOLDED PLASTIC RIGHT SIDE SPOILER KIT

- » **PLASTIC SPOILER BLADE:** Made of lightweight, molded high-impact plastic
- » 32" wide by 8 1/4" tall
- » **ALUMINUM ADJUSTABLE END PLATES:**
- » Made of premium high-strength aluminum with flat black powder-coated finish
- » 4-1/2" wide by 7" tall
- » CNC machined slots make for easy spoiler angle adjustment
- » Kit includes: 1-Plastic Spoiler and 2-Aluminum Adjustable End Plates and is available in 5 colors **-W -B -CB -G -R**

NEW!

Molded Plastic Right Side Spoiler Kit	32000-72820-X	\$69
Replacement Plastic Right Side Spoiler Blade	32000-47751-X	\$29
Replacement Adjustable End Plates, pair	32000-47851-X	\$40
Replacement Adjustable End Plate, left	32001-47851L-X	\$20
Replacement Adjustable End Plate, right	32001-47851R-X	\$20



Left & Right Side Replacement Plates

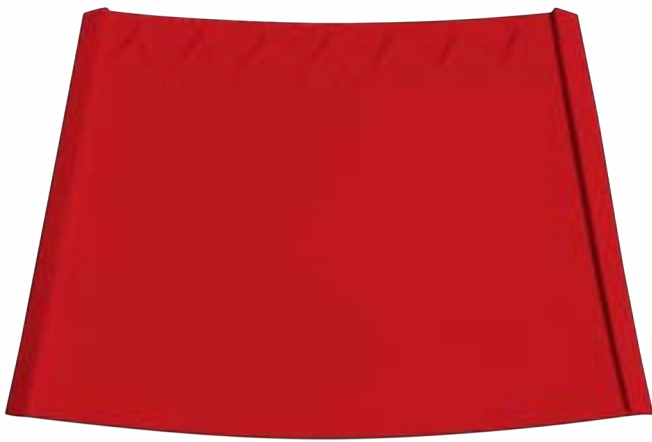

Enhanced design for improved aerodynamics

LIGHTWEIGHT COMPOSITE ROOF

- » Strong! Holds up to high speeds with minimal bracing
- » Advanced lightweight composite roof now made with Flame Retardant resin for added driver safety
- » 48" wide x 44" long, minimal bracing required
- » Weighs less than 7lbs!
- » Meets all sanctioning rules
- » Available in 5 colors

-W -B -CB -R -Y -OR

Roof	006-5101L-X	\$499
------	-------------	-------

Yellow composite body panels are special order parts, contact Five Star for availability and lead time*

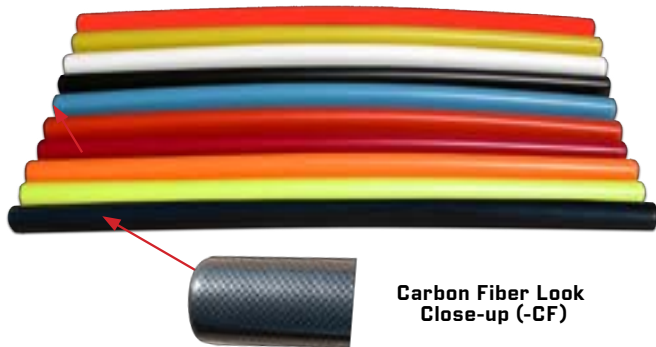

Carbon Fiber Look Close-up (-CF)

PLASTIC ROOF CAPS

- » Made of high-impact molded plastic
- » 45-1/4" long and weighs only 8oz!
- » Available in 11 colors including a carbon fiber look (appearance of carbon fiber)

-W -B -CB -R -Y -OR -FG -FO -FR -FY -CF

Roof Cap	006-500-x	\$35	\$38
----------	-----------	------	------

Shaped for peak aero performance with tremendous shear (tear) resistance



LIGHTWEIGHT COMPOSITE HOOD

- » Holds shape at all speeds with minimal or no bracing!
- » Made from advanced lightweight composites
- » Weighs less than 8lbs!
- » Slightly oversized and can be trimmed to fit
- » Available in 5 colors

-W -B -CB -R -Y

Hood	32003-33512-x	\$486
------	---------------	-------

Yellow composite body panels are special order parts, contact Five Star for availability and lead time*

OLDER STYLE



BODY PANELS

» FOR OLDER DIRT LATE MODEL BODY PANELS, VISIT OUR WEBSITE!

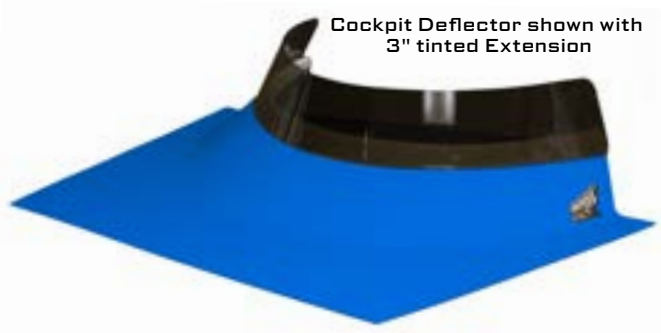

Cockpit Deflector shown with 3" tinted Extension

COCKPIT DEFLECTORS

- » High-impact molded plastic deflectors are ultra durable, withstands flying debris and diverts air around the driver
- » Available in 6 colors **-W -B -G -CB -R -Y**
- » Raise the height of your cockpit deflector using a polycarbonate Cockpit Extension to allow for more visibility
- » Cockpit Extension available in 3" and 4" height, clear and tinted

Cockpit Deflector, plastic	040-4106-X	\$74
Cockpit Extension, Clear, 3"	040-4107-CLR	\$46
Cockpit Extension, Tinted, 3"	040-4107-TNT	\$46
Cockpit Extension, Clear, 4"	040-4108-CLR	\$52
Cockpit Extension, Tinted, 4"	040-4108-TNT	\$52



3" Air Filter Deflector

5" Air Filter Deflector

6" Air Filter Deflector

NEW!

AIR FILTER DEFLECTORS

- » Lightweight, high-impact molded plastic deflectors have a sleek aerodynamic design that provides maximum air filter protection
- » Three options to choose from, 3", 5", and 6" height
- » Available in 4 colors including a carbon fiber look; appearance of carbon fiber, at a fraction of the cost.

-W -CB -R -CF

Air Deflector, 3" tall x 16" wide	040-4100-X	\$40	\$47
Air Deflector, 5" tall x 15" wide	040-4101-X	\$40	\$47
Air Deflector, 6" tall x 18" wide	040-4102-X	\$48	\$55

OIL COOLER SCOOP

- » High-impact molded plastic scoop has a sleek aerodynamic design that directs air for cooling
- » Can be mounted forward or backward!
- » Available in white and a carbon fiber look; appearance of carbon fiber, at a fraction of the cost.

-W -CF

Oil Cooler Scoop	040-4105-X	\$29
------------------	------------	------



PLASTIC LOWER NOSE SUPPORT

- » This lightweight, durable plastic 37" long nose support is made out of .350" thick polyethylene
- » Fits either side of your nose
- » Two are required for a complete install
- » Available in black only

-B

Nose Support	32003-410-1	\$42 EA
--------------	-------------	---------



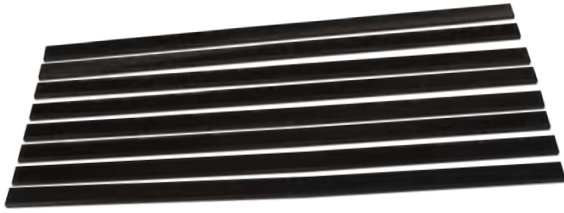

1-1/4" wide x 36" long x (flat)

STANDARD PLASTIC BODY BRACES

- » Constructed of the same specially-blended, high-impact plastic as our MD3 noses
- » Each lightweight brace weighs only 7 oz
- » Perfect for taking abuse on the dirt
- » 1-1/4" wide x 36" long x (flat) 0.30" thick
- » Trims easily to fit your needs

		-B
Single Body Brace	040-8000	\$11 ea
Pkg of (8) Body Braces	040-8000-8	\$58

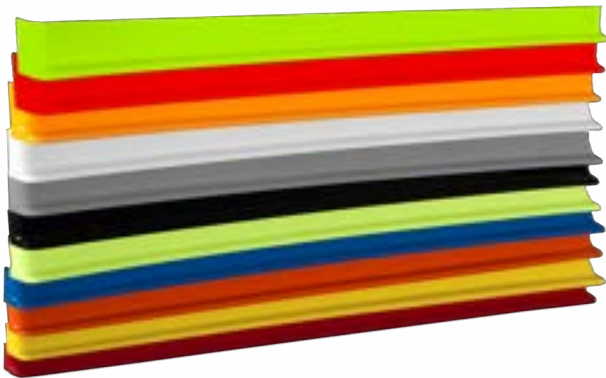

PLASTIC ROCKER PANEL

- » Aerodynamically designed for the best side force
- » These 77-3/4" x 7-1/4" lightweight, high-impact plastic rockers are aerodynamically designed for the best side force
- » They are easy to mount and add structural integrity to side body panels
- » Available in 11 colors

-W -B -G -CB -R -Y -OR -FG -FO -FR -FY

Rocker Panel	007-5500-x	\$40ea	\$46ea
--------------	------------	--------	--------



BODY PANEL



DIMENSIONS

» FOR INDIVIDUAL BODY PANEL DIMENSIONS, VISIT FIVESTARBODIES.COM

DIRT LATE MODEL

VINYL NOSE GRAPHIC ID KITS

- » **HIGH-TACK ADHESION:** Our outdoor durable vinyl with aggressive adhesive ensures that your nose graphics stay securely in place
- » **EXTREME DURABILITY:** Glossy laminated surface provides excellent protection to maintain their brilliant appearance even under the harshest conditions
- » **EASY APPLICATION:** Installing our graphics is a breeze! With our easy-to-follow application instructions, professional-grade vinyl, and the all new MD3 Adhesion Promoter, you can achieve a smooth, bubble-free finish that looks like it was applied by a pro!



CHEVROLET CAMARO
32133-44142 Evolution 2 & Evolution Nose ID Kit \$37



CHEVROLET CAMARO
165-410-ID Original Nose ID Kit \$37



FORD MUSTANG
32323-44141 Evolution 2 & Evolution Nose ID Kit \$37



CHEVROLET SS
32123-44141 Evolution 2 & Evolution Nose ID Kit \$37

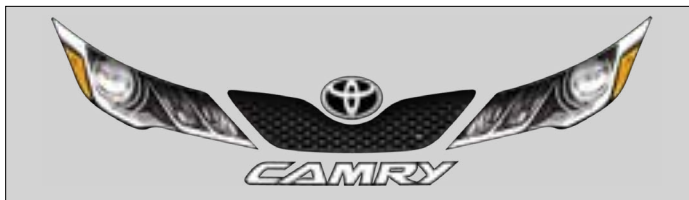

TOYOTA CAMRY
740-410-ID Evolution 2, Evolution and Original Nose ID Kit \$37

NEW!

- » **ACHIEVE MAXIMUM VINYL ADHESION BY USING MD3 ADHESION PROMOTER**
- » Details and ordering info on page 147





DIRT MODIFIED

PROVEN BEST BODY PANELS IN ALL DIRT RACING

The MD3 Dirt Modified High-Impact Plastic body panels, make it the ultimate body choice in all dirt modified racing due to its durability, performance, and resilience on the track.





- » Molded plastic panels provide unmatched flexibility and durability!
- » Premium plastic materials available exclusively and only in MD3 products
- » Achieve maximum vinyl adhesion by using MD3 Adhesion Promoter
- » See color availability options for all body panels and components in ordering section



DIRT MODIFIED

BODY PANELS & COMPONENTS

FIVE STAR BODY PANELS ARE DESIGNED TO MAINTAIN PRECISE FIT WITH OPTIMIZED AERODYNAMICS!

OVERSIZED 48" X 48" PANEL IS TRIM-TO-FIT FOR YOUR CUSTOM APPLICATION



PLASTIC NOSE FILLER PANEL

- » High-impact plastic deflects debris and resists chipping, denting, bending
- » Outperforms traditional aluminum panels in every way; this panel won't dent!
- » Flame retardant material with high heat distortion temperature
- » Same weight per square foot as .040" aluminum!
- » Available in 5 colors **-W -B -G -CB -R**

Nose Filler Panel	34000-35851-x	\$124
-------------------	---------------	-------



PLASTIC LOWER AERO VALANCE

- » This high-impact plastic adjustable 3-piece assembly has overlapping flanges that fit together perfectly making it easy to mount for desired ground clearance
- » Universal fit for modified aluminum noses up to 45" wide
- » Adjustable front overhang up to 42"
- » Available in 11 colors **-W -B -G -CB -R -Y -OR -FG -FO -FR -FY**

Lower Aero Valance	3022- 417-x	\$95	\$120
--------------------	-------------	------	-------

NOT FOR USE WITH PLASTIC NOSE!



Overlapping flanges make this easy to install.

4-PIECE PLASTIC NOSE

- » This 4-piece high-impact plastic nose is oversized, you cut to fit your modified applica
- » Trim to fit around your suspension component
- » Legal for all sanctioning bodies
- » Available in 5 colors **-W -B -G -CB -R**

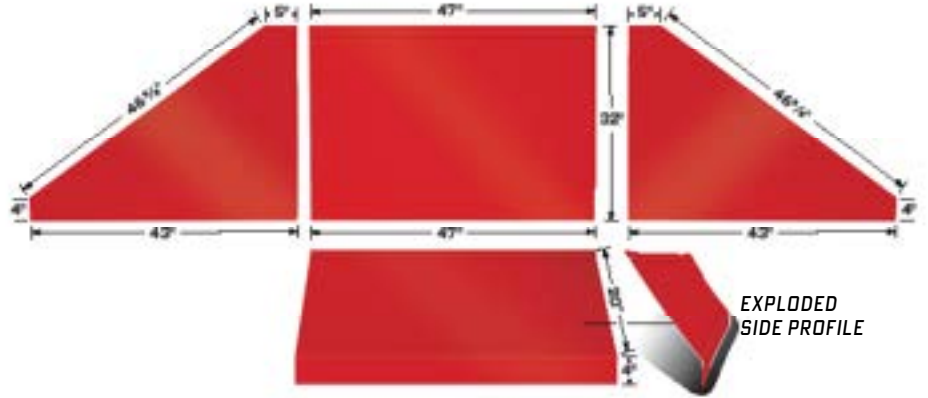

Nose, Complete Kit	34001-41051-x	\$16
Nose Side, left	34001-41451-xL	\$32
Nose Side, right	34001-41451-xR	\$32
Nose, Center, Upper	34001-41251-x	\$52
Nose, Center, Lower	34001-41151-x	\$52

PLASTIC QUARTER PANELS

NEW!

- » High-impact plastic out performs aluminum in every way
- » Resists chipping, denting, & bending
- » Panels are oversized, cut to fit your custom application
- » Meets all flame resistance test requirements
- » Approved for competition by all major national sanctioning series
- » Available in 5 colors **-W -B -CB -G -R**

Quarter Panel, right	34001-27351-xR	\$63
Quarter Panel, left	34001-27351-xL	\$72

PLASTIC DOORS

NEW!

- » High-impact plastic out performs aluminum in every way
- » Resists chipping, denting, & bending
- » Panels are oversized, cut to fit your custom application
- » Meets all flame resistance test requirements
- » Approved for competition by all major national sanctioning series
- » Available in 5 colors **-W -B -CB -G -R**

Door, right	34001-21051-xR	\$91
Door, left	34001-21051-xL	\$98

LOWER AERO VALANCE SUPPORT

- » Add another layer of support with this lightweight, durable polyethylene plastic valance support
- » It is made out of .350" thick polyethylene and will fit either side of your lower aero valance
- » Two are required for a complete install
- » Available in black only



Lower Aero Valance Support	3022-410-1	\$26 ea
----------------------------	------------	---------



3" Flat Scoop



5" Flat Scoop

HOOD SCOOPS

- » Lightweight, molded high-impact plastic scoops are shaped for peak aero performance
- » Two options to choose from: 3" tall x 16" wide, 5" tall x 16" wide
- » Available in 4 colors including a carbon fiber look; appearance of carbon fiber, at a fraction of the cost.

-W -CB -R -CF

Hood Scoop, 3" tall x 16" wide, flat	040-4115-x	\$52	\$59
Hood Scoop, 5" tall x 16" wide, flat	040-4113-x	\$52	\$59



3" Air Filter Deflector



5" Air Filter Deflector



6" Air Filter Deflector

NEW!

AIR FILTER DEFLECTORS

- » Lightweight, high-impact molded plastic deflectors have a sleek aerodynamic design that provides maximum air filter protection
- » Three options to choose from, 3", 5", and 6" height
- » Available in 4 colors including a carbon fiber look; appearance of carbon fiber, at a fraction of the cost.

-W -CB -R -CF

Air Deflector, 3" tall x 16" wide	040-4100-x	\$40	\$47
Air Deflector, 5" tall x 15" wide	040-4101-x	\$40	\$47
Air Deflector, 6" tall x 18" wide	040-4102-x	\$48	\$55



OIL COOLER SCOOP

- » High-impact molded plastic scoop has a sleek aerodynamic design that directs air for cooling
- » Can be mounted forward or backward!
- » Available in white and a carbon fiber look; appearance of carbon fiber, at a fraction of the cost.

-W -CF

Oil Cooler Scoop	040-4105-x	\$29
------------------	------------	------

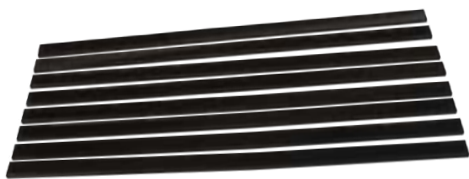

1-1/4" wide x 36" long x (flat)

STANDARD PLASTIC BODY BRACES

- » Constructed of the same specially-blended, high-impact plastic as our MD3 noses
- » Each lightweight brace weighs only 7 oz
- » Perfect for taking abuse on the dirt
- » 1-1/4" wide x 36" long x (flat) 0.30" thick
- » Trims easily to fit your needs

Single Body Brace	040-8000	\$11 ea
Pkg of (8) Body Braces	040-8000-8	\$58

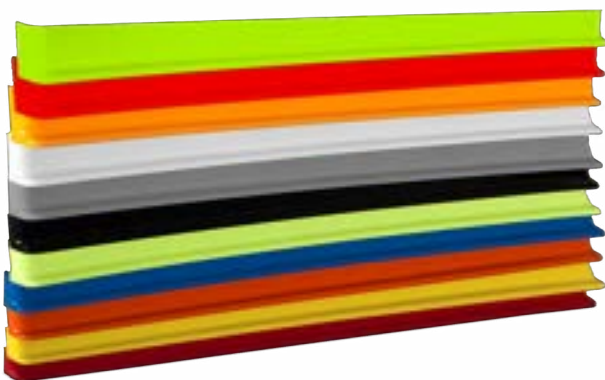

PLASTIC ROCKER PANEL

- » Aerodynamically designed for the best side force
- » These 77-3/4" x 7-1/4" lightweight, high-impact plastic rockers are aerodynamically designed for the best side force
- » They are easy to mount and add structural integrity to side body panels
- » Available in 11 colors

-W -B -G -CB -R -Y -OR -FG -FO -FR -FY

Rocker Panel	007-5500-x	\$40ea	\$46ea
--------------	------------	--------	--------

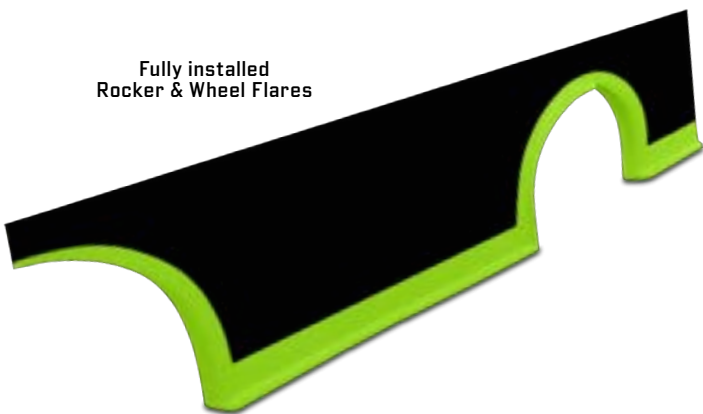

Fully installed
Rocker & Wheel Flares

PLASTIC WHEEL FLARES

- » Prevent tires from being cut with these lightweight, high-impact plastic wheel flares
- » Inset wheel flares fit around the full rear wheel opening
- » Available in 11 color

-W -B -G -CB -R -Y -OR -FG -FO -FR -FY

Wheel Flares (3pcs left)	007-261-xL	\$54	\$67
Wheel Flares (3pcs right)	007-261-xR	\$54	\$67

WHEEL FLARE & ROCKER KIT

- » These inter-connecting pieces enhance downforce and side force while adding rigidity to the sides of the body!
- » 3 rockers complete installation, 1 rocker between front and rear wheel flares and a 1/2-piece behind rear wheel flare

Wheel Flare & Rocker Kit	007-2615-x	\$228	\$272
--------------------------	------------	-------	-------



» FOR INDIVIDUAL BODY PANEL DIMENSIONS, VISIT FIVESTARBODIES.COM



DIRT GRAND NATIONAL

A COMPLETE BODY FOR DIRT SPORTSMAN RACING

The Dirt Grand National body offers durability, style,
and everything a Dirt Sportsman racer needs
to be successful on the race track.



- » High-impact molded plastic panels provide superior flexibility while maintaining structural integrity during impact!
- » Composite roof with attached windshield, A-post, and cowl
- » Common body uses different noses for brand identity
- » Designed to fit metric-style chassis
- » Panels available in 2 colors



DIRT GRAND NATIONAL

BODY PANELS & OPTIONS

HOW TO ORDER YOUR BODY IN 2 QUICK & EASY STEPS

» 1. SELECT PANEL COLOR » 2. SELECT NOSE MAKE

COMPLETE BODY PACKAGE

			-W	-B
Bumper Cover, Rear, high-impact plastic	-W -B -CB -R	460-450-x		\$155
Deck Lid, aluminum, white		661-310A-W		\$76
Deck Lid Filler Panel, aluminum, white		700-3200A-W		\$44
Door, aluminum, left, white		700-21A-WL		\$112
Door, aluminum, right, white		700-21A-WR		\$112
Fender, aluminum, left, black or white		662-23A-xL		\$99
Fender, aluminum, right, black or white		662-23A-xR		\$99
Hood, flat, composite, white		362-3301-W		\$320
Nose, high-impact plastic (SPECIFY MAKE: CHEVROLET-660; FORD-570; TOYOTA-720)	-W -B -CB -R	xxx-410-x		\$164
Quarter Panel, aluminum, left, white		700-27A-WL		\$159
Quarter Panel, aluminum, right, white		700-27A-WR		\$159
Quarter Window Panel, composite, left, white		700-280-WL		\$85
Quarter Window Panel, composite, right, white		700-280-WR		\$85
Rocker Panel, fits either side, aluminum, black or white (2 REQUIRED)		000-5500A-x		\$39
Rocker Panel, fits either side, aluminum, black or white (ENTERED TWICE TO SHOW PACKAGE PRICE)		000-5500A-x		\$39
Roof, composite, white		700-5102-W		\$372
COMPLETE BODY PACKAGE PRICE		700-112-x		\$2,119

TO ENHANCE YOUR BODY PACKAGE, CHOOSE FROM THE OPTIONS BELOW:

BODY PACKAGE OPTIONS & UPGRADES (ADD OR SUBTRACT TO PACKAGE PRICE ABOVE FOR TOTAL)

								-W	-B	+/- PKG PRICE
Fenders, high-impact plastic, left, black or white										\$150 +\$51
Fenders, high-impact plastic, right, black or white										\$150 +\$51
Hood, composite, 2-1/2" scoop, black or white										\$320 +\$0
Spoilers: 60" wide	5" (90°)	5" (70°)	5" (55°)	6-1/2" (90°)	6-1/2" (70°)	6-1/2" (55°)				
Complete, aluminum	661-6749	661-6747	661-6745	661-6739	661-6737	661-6735	\$129			+\$129
Complete, aluminum, black	661-6749-B	661-6747-B	661-6745-B	661-6739-B	661-6737-B	661-6735-B	\$139			+\$139

UPGRADE YOUR NOSE, FENDERS, & HOOD TO A NEW MODERN STYLE!

MODERN STYLE NOSES, FENDERS & HOODS



CAMARO NOSE & ID KIT



MUSTANG NOSE & ID KIT



HALF FENDER



FULL FENDER



SCOOPED HOOD

			-W	-B	-CB	-R
Chevrolet Camaro Nose		20132-41051-x				\$177
Chevrolet Camaro Nose ID Kit		20132-44141				\$37
Ford Mustang Nose		20321-41051-x				\$177
Ford Mustang Nose ID Kit		20321-44141				\$37
Fender, half, high-impact plastic, left or right		20002-23051-xLorR				\$116
Fender, full, high-impact plastic, left		11002-23051-xL				\$150
Fender, full, high-impact plastic, right		13002-23051-xR				\$150
Hood, composite, scooped		20002-33311-x				\$320

DIRT GRAND NATIONAL

FEATURED BODY ACCESSORIES

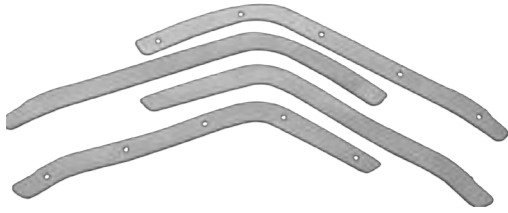

FENDER-TO-NOSE BACK UP PLATES:

- » 4 Piece Kit Includes: 2 Fronts & 2 Rear Plates (ENOUGH FOR BOTH SIDES)
- » Pre-drilled holes in the necessary locations for quick & easy mounting
- » Made of .063" thick aluminum
- » For more details & ordering info page 142



HIGH-IMPACT PLASTIC ROCKER PANELS:

- » Aerodynamically designed for the best side force
- » They are easy to mount & add structural integrity to side body panels
- » For more details & ordering info page 84

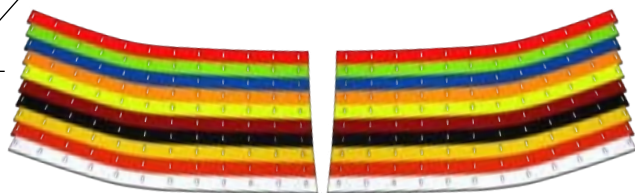

HIGH-IMPACT PLASTIC WEAR STRIPS:

- » Height adjustable to seal the nose to the track to optimize aero and protection from wear
- » CNC-machined from Five Star's exclusive durable plastic
- » For more details & ordering info page 127



UNIVERSAL BODY MOUNTING KIT:

- » Everything you need to install a wear strip
- » Universal fit that can be used anywhere on a race car
- » Plastic Kit comes in all black and features Delrin washers that withstand repeated impact and stress
- » For more details & ordering info page 127

» GO TO PAGES 122-145 TO SEE ALL ACCESSORIES FOR THIS BODY STYLE

PRICING SUBJECT TO CHANGE WITHOUT NOTICE



TA2 ROAD RACING

EXCLUSIVELY DESIGNED FOR TRANS AM COMPETITION

Constructed from premium composite materials, the TA2 Body is the perfect combination of a stock appearance and top-tier performance on the track.





- » Tremendous shear (tear) resistance to withstand impact and prevent body debris
- » The Camaro and Mustang come with a narrow option for European competition
- » Body made of Advanced Lightweight Composite and Ultraglass
- » Flange-fit panels fit flush with no exposed fasteners
- » Repeatable fit for ease of replacement
- » White finish on all parts

TA2 CAMARO

BODY PANELS & OPTIONS

ORDER YOUR BODY THROUGH AN AUTHORIZED DEALER >> PAGE 103

NOTE: TRANS AM CONTROLS DISTRIBUTION OF ALL TA2 BODY PANELS. ALL PANEL ORDERS MUST GO THROUGH A FIVE STAR AUTHORIZED DEALER.

COMPLETE BODY PACKAGE

Deck Lid, Ultraglass	81131-31013	*CALL
Door, Ultraglass, left or right	81131-21013LorR	*CALL
Fender, Ultraglass, left or right	81131-23013LorR	*CALL
Greenhouse, Front, advanced lightweight composite	81131-51312	*CALL
Greenhouse, Rear, advanced lightweight composite	81131-51512	*CALL
Hood, advanced lightweight composite	81131-33012	*CALL
Nose, Upper, advanced lightweight composite	81133-41212	*CALL
Nose, Lower, advanced lightweight composite, common	81001-41112	*CALL
Quarter Panel, Ultraglass, left or right	81131-27313LorR	*CALL
Rear Bumper Cover, advanced lightweight composite	81131-45012	*CALL
Quarter Window, 1/8", coated, black-out border, left or right	81131-65243LorR	\$59 ea
Rear Window, 1/8", coated, black-out border	81131-61243	\$449
Windshield, 3/16", coated, cut, bev, drilled, black-out border	81131-63343	\$510
COMPLETE BODY PACKAGE PRICE		*CALL

*ALL WINDOWS ARE PRECUT TO FIT, BEVELED & DRILLED, WITH BLACK-OUT BORDER UNLESS OTHERWISE SPECIFIED.

TO ENHANCE YOUR BODY PACKAGE, CHOOSE FROM THE OPTIONS BELOW:

BODY PACKAGE OPTIONS & UPGRADES

Door, increased access, upper, Ultraglass, left	81131-21713L	*CALL
Door, increased access, lower, Ultraglass, left	81131-21813L	*CALL
Fender, narrow, Ultraglass, left or right	81132-23013LorR	*CALL
Quarter Panel, narrow, Ultraglass, left or right	81132-27313LorR	*CALL
Nose, Lower, narrow, advanced lightweight composite, common	81002-41112	*CALL
Nose, Lower, high-impact plastic	81001-41151-W	*CALL
Nose, Upper, narrow, advanced lightweight composite	81132-41212	*CALL
Nose, Upper, high-impact plastic	81131-41251-W	*CALL
Vent Window Kit, .093" coated, cut polycarbonate pieces & aluminum brackets	81001-66122	*CALL

VINYL NOSE & BUMPER COVER GRAPHIC ID KITS FOR A REALISTIC OEM LOOK!

PRINTED ON OUTDOOR DURABLE HIGH-TACK VINYL • GLOSSY LAMINATED SURFACE PROVIDES EXCELLENT PROTECTION



CHEVROLET CAMARO

Nose ID	81131-44142	\$42
Nose ID, 2018	81131-44141	\$42
Bumper Cover ID	81131-44541	\$29

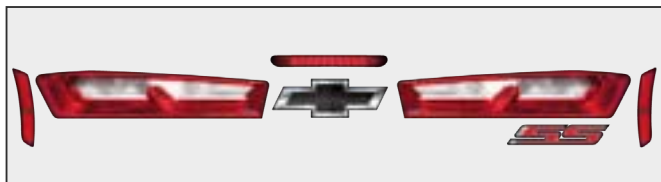

TA2 CAMARO

DIMENSIONS & TEMPLATES

FIVE STAR BODIES ARE DESIGNED TO MAINTAIN PRECISE FIT WITH OPTIMIZED AERODYNAMICS!

CHEVROLET CAMARO: WIDTHS

A	B	C	D
79" MAX	77" MIN	79" MAX	74" MIN (measured at the bottom of wheel opening)

ROOF HIGH POINT: Measured 23" back from top of windshield. *The distance from the center line of the rear axle to the rear of the bumper cover is different on the Camaro & Mustang. However, the distance from the center line of the rear axle to the rear of the deck lid is the same on both body styles. **Measured at the intersection of the hood and nose at centerline. ***Measured at the centerline.

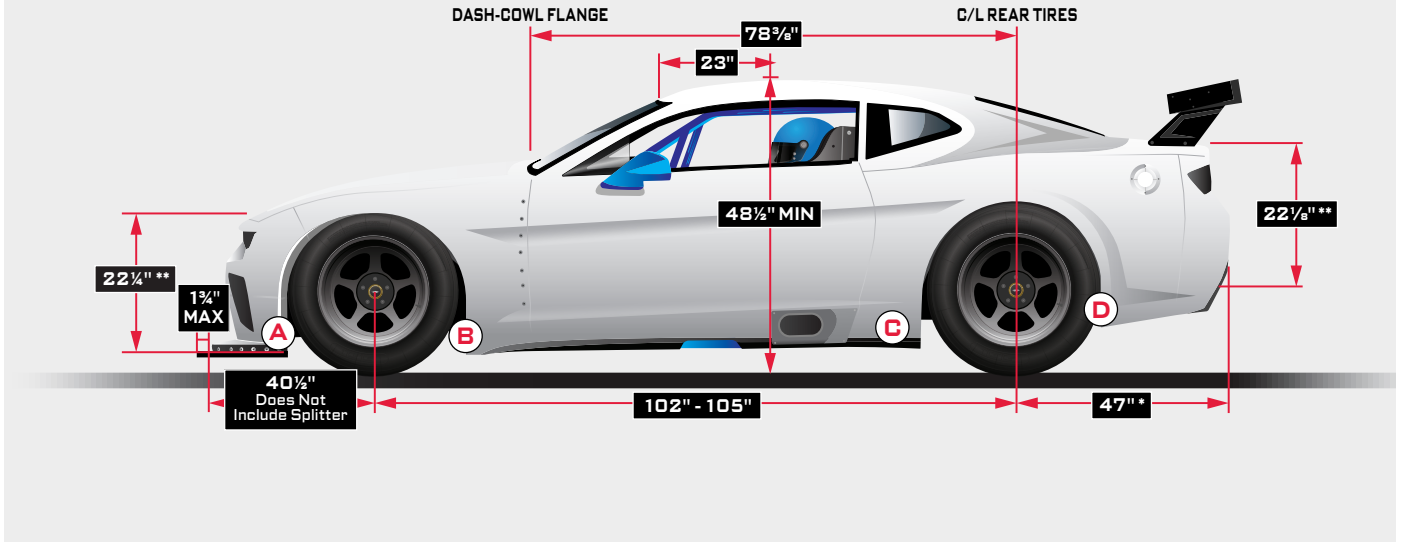

BODY PANEL



DIMENSIONS

» FOR INDIVIDUAL BODY PANEL DIMENSIONS, VISIT FIVESTARBODIES.COM

TA2 CAMARO TEMPLATES ENSURE A CORRECT FIT FOR OPTIMUM AERODYNAMICS

- » Templates ensure body is installed correctly
- » Nose Centerline templates are model specific
- » Body Centerline templates can check all models
- » Available in wood or aluminum
- » Master sets available with templates for all models

Template, Body Centerline, wood	81131-82191	\$40
Template, Nose Centerline, wood	81133-82491	\$23
Template, Body Centerline, aluminum	81131-82133	\$125
Template, Nose Centerline, aluminum	81133-82433	\$60

» FOR MORE BODY MOUNTING TOOLS, GO TO PAGES 124-147

PRICING SUBJECT TO CHANGE WITHOUT NOTICE

ABC LMSC TRUCK RAV/MODIFIED OUTLAW/LATE MODEL SPORTSMAN STREET STOCK MOD3 LATE MODEL MOD3 MODIFIED DIRT GRAND NATL TA2 PRO STOCK/MOD FUNNY CAR WINDOWS ACCESSORIES

TA2 MUSTANG

BODY PANELS & OPTIONS

ORDER YOUR BODY THROUGH AN AUTHORIZED DEALER >> PAGE 103

NOTE: TRANS AM CONTROLS DISTRIBUTION OF ALL TA2 BODY PANELS. ALL PANEL ORDERS MUST GO THROUGH A FIVE STAR AUTHORIZED DEALER.

COMPLETE BODY PACKAGE

Deck Lid, Ultraglass	81321-31013	*CALL
Door, Ultraglass, left or right	81321-21013LorR	*CALL
Fender, Ultraglass, left or right	81321-23013LorR	*CALL
Greenhouse, Front, advanced lightweight composite	81321-51312	*CALL
Greenhouse, Rear, advanced lightweight composite	81321-51512	*CALL
Hood, advanced lightweight composite	81321-33012	*CALL
Nose, Upper, advanced lightweight composite	81321-41212	*CALL
Nose, Lower, advanced lightweight composite, common	81001-41112	*CALL
Quarter Panel, Ultraglass, left or right	81321-27313LorR	*CALL
Rear Bumper Cover, advanced lightweight composite	81321-45012	*CALL
Quarter Window, 1/8", coated, black-out border, left or right	81321-65243LorR	\$59 ea
Rear Window, 1/8", coated, black-out border	81321-61243	\$449
Windshield, 3/16", coated, cut, bev, drilled, black-out border	81321-63343	\$510
COMPLETE BODY PACKAGE PRICE		*CALL

*ALL WINDOWS ARE PRECUT TO FIT, BEVELED & DRILLED, WITH BLACK-OUT BORDER UNLESS OTHERWISE SPECIFIED.

TO ENHANCE YOUR BODY PACKAGE, CHOOSE FROM THE OPTIONS BELOW:

BODY PACKAGE OPTIONS & UPGRADES

Door, increased access, upper, Ultraglass, left	81321-21713L	*CALL
Door, increased access, lower, Ultraglass, left	81321-21813L	*CALL
Fender, narrow, Ultraglass, left or right	81322-23013LorR	*CALL
Quarter Panel, narrow, Ultraglass, left or right	81322-27313LorR	*CALL
Nose, Lower, narrow, advanced lightweight composite, common	81002-41112	*CALL
Nose, Lower, high-impact plastic	81001-41151-W	*CALL
Nose, Upper, narrow, advanced lightweight composite	81322-41212	*CALL
Nose, Upper, high-impact plastic	81321-41251-W	*CALL
Vent Window Kit, .093" coated, cut poly pieces & aluminum brackets	81001-66122	*CALL

VINYL NOSE & BUMPER COVER GRAPHIC ID KITS FOR A REALISTIC OEM LOOK!

PRINTED ON OUTDOOR DURABLE HIGH-TACK VINYL • GLOSSY LAMINATED SURFACE PROVIDES EXCELLENT PROTECTION



FORD MUSTANG

Nose ID	81321-44141	\$42
Bumper Cover ID	81321-44541	\$29

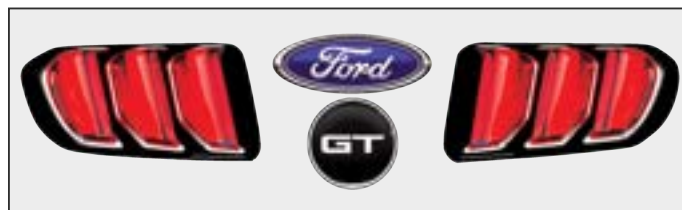

TA2 MUSTANG

DIMENSIONS & TEMPLATES

FIVE STAR BODIES ARE DESIGNED TO MAINTAIN PRECISE FIT WITH OPTIMIZED AERODYNAMICS!

FORD MUSTANG: WIDTHS

A	B	C	D
79" MAX	77" MIN	79" MAX	74" MIN (measured at the bottom of wheel opening)

ROOF HIGH POINT: Measured 23" back from top of windshield. *The distance from the center line of the rear axle to the rear of the bumper cover is different on the Camaro & Mustang. However, the distance from the center line of the rear axle to the rear of the deck lid is the same on both body styles. **Measured at the intersection of the hood and nose at centerline. ***Measured at the centerline.

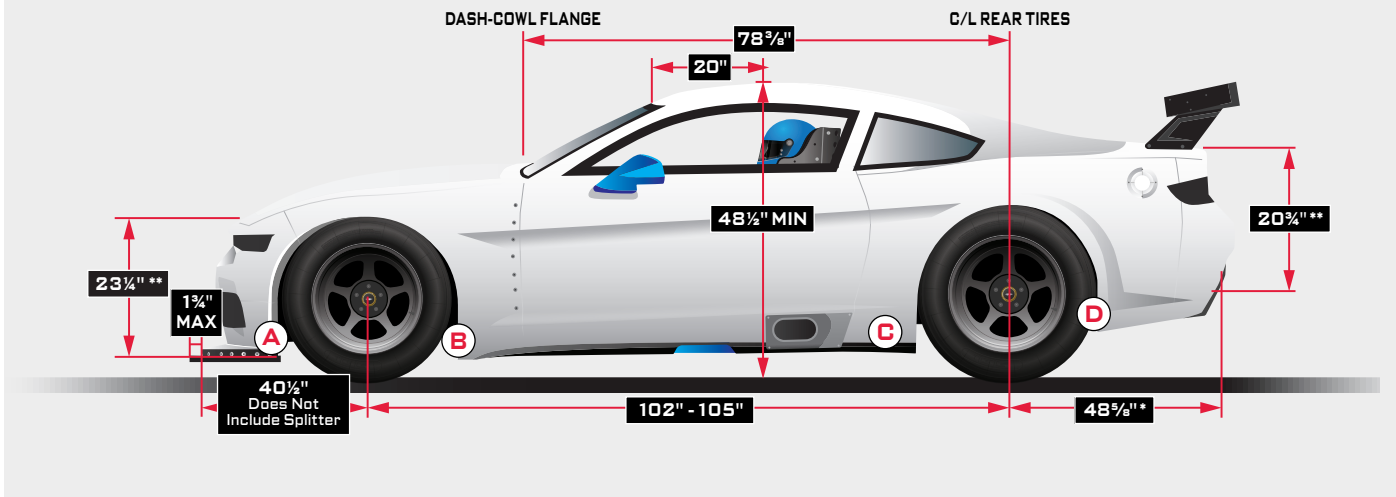

» FOR INDIVIDUAL BODY PANEL DIMENSIONS, VISIT FIVESTARBODIES.COM

TA2 MUSTANG TEMPLATES ENSURE A CORRECT FIT FOR OPTIMUM AERODYNAMICS

- » Templates ensure body is installed correctly
- » Nose Centerline templates are model specific
- » Body Centerline templates can check all models
- » Available in wood or aluminum
- » Master sets available with templates for all models

Template, Body Centerline, wood	81321-82191	\$40
Template, Nose Centerline, wood	81321-82491	\$23
Template, Body Centerline, aluminum	81321-82133	CALL
Template, Nose Centerline, aluminum	81321-82433	\$60

» FOR MORE BODY MOUNTING TOOLS, GO TO PAGES 124-147

PRICING SUBJECT TO CHANGE WITHOUT NOTICE

TA2 CHALLENGER

BODY PANELS & OPTIONS

ORDER YOUR BODY THROUGH AN AUTHORIZED DEALER >> PAGE 103

NOTE: TRANS AM CONTROLS DISTRIBUTION OF ALL TA2 BODY PANELS. ALL PANEL ORDERS MUST GO THROUGH A FIVE STAR AUTHORIZED DEALER.

COMPLETE BODY PACKAGE

Deck Lid, standard composite	81521-31011	*CALL
Deck Lid Filler Panel, standard composite	81521-32011	*CALL
Door, standard composite, left or right	81521-21011LorR	*CALL
Fender, standard composite, left or right	81521-23011LorR	*CALL
Greenhouse, Front, standard composite	81521-51311	*CALL
Greenhouse, Rear, standard composite	81521-51511	*CALL
Hood, advanced lightweight composite	81521-33012	*CALL
Nose, standard standard composite	81521-41011	*CALL
Quarter Panel, standard composite, left or right	81521-27311LorR	*CALL
Rear Bumper Cover, standard composite	81521-45011	*CALL
Quarter Window, 1/8", coated, black-out border, left or right	81521-65243LorR	\$59 ea
Rear Window, 1/8", coated, black-out border	81521-61243	\$449
Windshield, 3/16", coated, cut, bev, drilled, black-out border	81521-63343	\$510
COMPLETE BODY PACKAGE PRICE		*CALL

*ALL WINDOWS ARE PRECUT TO FIT, BEVELED & DRILLED, WITH BLACK-OUT BORDER UNLESS OTHERWISE SPECIFIED.

TO ENHANCE YOUR BODY PACKAGE, CHOOSE FROM THE OPTIONS BELOW:

BODY PACKAGE OPTIONS & UPGRADES

Door, increased access, upper, small, composites, left	81521-21711L	*CALL
Door, increased access, lower, large, composites, left	81521-21811L	*CALL

VINYL NOSE & BUMPER COVER GRAPHIC ID KITS FOR A REALISTIC OEM LOOK!

PRINTED ON OUTDOOR DURABLE HIGH-TACK VINYL • GLOSSY LAMINATED SURFACE PROVIDES EXCELLENT PROTECTION



DODGE CHALLENGER

Nose ID	81521-44141	\$42
Bumper Cover ID	81521-44541	\$29



TA2 CHALLENGER

DIMENSIONS & TEMPLATES

FIVE STAR BODIES ARE DESIGNED TO MAINTAIN PRECISE FIT WITH OPTIMIZED AERODYNAMICS!

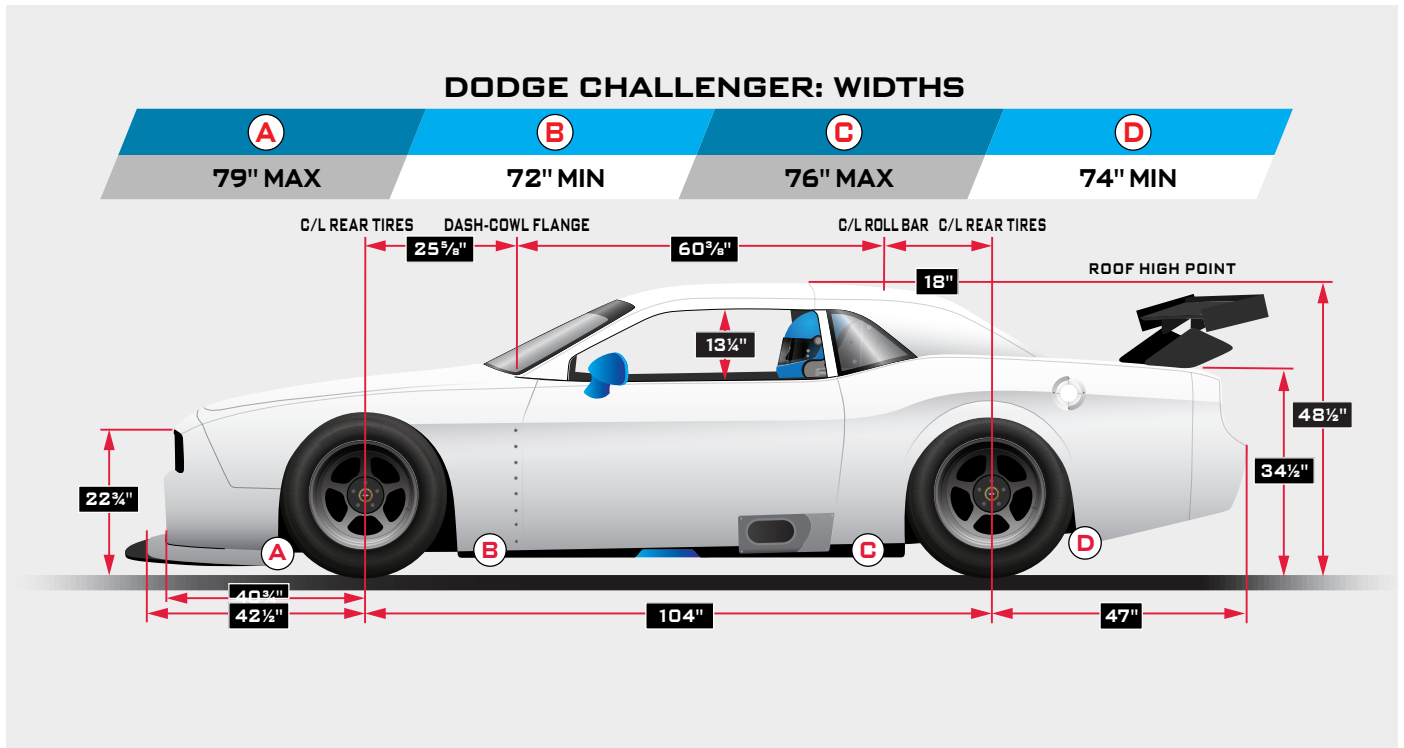

» FOR BODY MOUNTING TOOLS, GO TO PAGES 124-147

BODY PANEL



DIMENSIONS

» FOR INDIVIDUAL BODY PANEL DIMENSIONS, VISIT FIVESTARBODIES.COM

AUTHORIZED FIVE STAR TA2 BODY DEALERS

HOWE RACING ENTERPRISES

3195 LYLE ROAD
BEAVERTON, MI 48612
PH: (989) 435-7080
HOWERACING.COM

JEFFERSON RACE CARS

1660 STATE ROUTE 410
NACHES, WA 98937
PH: (509) 952-6233
JEFFERSON-RACING.COM

MIKE COPE RACING ENTERPRISES, INC.

11692 56TH COURT NORTH
CLEARWATER, FL 33760
PH: (727) 201-8910
MIKECOPERACECARS.COM

M1-SLR

71 CARRERA STREET
ST. AUGUSTINE, FL 32084
PH: (704) 746-7264
TEAMSLR.COM/M1-RACECARS

TA2 ROAD RACE

FEATURED BODY ACCESSORIES

ALUMINUM WINDOW BRACES

- » Strongest window braces on the market
- » Designed to the exact contour of your Five Star windows
- » Made of premium high-strength aluminum with flat black powder-coated finish
- » Foam-padded surface won't scratch your windows
- » Pre-drilled holes to mount adjustable bracing from the interior dash
- » **Kit includes:** 3 aluminum braces and weighs less than 2 lbs

Front Braces, Chevrolet	26-1/8" x 1"	81131-76333	\$76
Rear Braces, Chevrolet	27-1/4" x 1"	81131-76133	\$76
Front Braces, Ford	28-1/4" x 1"	81321-76333	\$76
Rear Braces, Ford	34-7/8" x 1"	81321-76133	\$76



CHEVROLET WINDSHIELD BRACES

WEIGHS
7.3280Z



CHEVROLET REAR BRACES



LOWER NOSE SCREEN

- » Protects the radiator from debris penetration
- » Frame is laser cut from lightweight aluminum
- » Screen is high strength stainless steel (1/4" MESH IS WELDED)
- » Durable black powder-coated finish
- » Weighs only 10.32oz

Nose Screen, common	81001-464338	\$55
---------------------	--------------	------



POLYCARBONATE DOOR VENT WINDOWS

- » Vent windows give cars a proven performance gain in the wind tunnel
- » Precut to fit, mar-resistant coated, clear .093" polycarbonate
- » Laser cut aluminum mounting brackets

Precut-to-fit, set of 2	81001-66122	\$33
-------------------------	-------------	------



TA2 ROAD RACE

BODY ACCESSORIES

LOWER NOSE UNIVERSAL SPLITTER

- » 2 piece 5/16" thick black high-impact plastic material
- » CNC-routed mounting points
- » Weighs 21 lbs
- » Approved for use in Trans Am Racing Series

Splitter	81001-41851	\$118
----------	-------------	-------

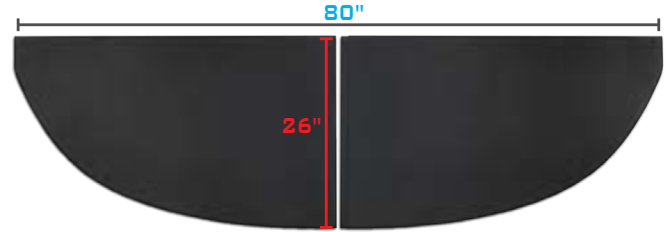

FRONT & REAR BUMPERS

- » Now formed using CNC progressive tube bending technology
- » Fits the exact contour of Five Star noses and bumper covers for maximum protection and ease of installation
- » Formed from 1-1/2" OD round steel tubing

Front, Chevrolet, .065" steel	81131-71162	\$48
Rear, Chevrolet, .065" steel	81131-71662	\$48
Front, Ford, .065" steel	81321-71162	\$48
Rear, Ford, .065" steel	81321-71662	\$48



ALUMINUM HOOD PIN BRACKETS

- » Pre-formed to fit the nose & hood precisely
- » 3/4" square option, & will work with our 3/8" hood pins

Bracket, Chevrolet	81131-34333	\$55
Bracket, Ford	81321-34333	\$55

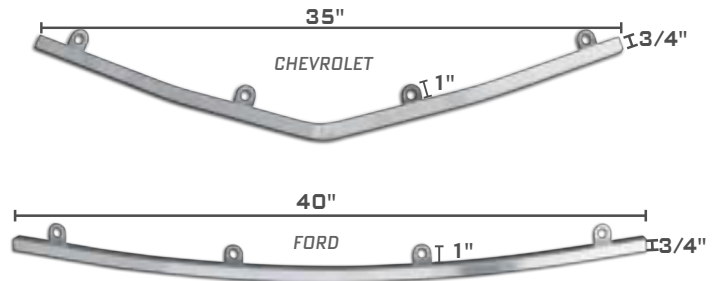

CONVEX RACING MIRROR

- » This convex glass mirror gives you the best view of your competition, includes a bracket kit for easy installation
- » All black frame with black anodized machined aluminum brackets
- » Only weighs 19 oz

Convex Glass Mirror	00001-85020	\$39
---------------------	-------------	------





PRO STOCK / PRO MOD

ENGINEERED FOR MAXIMUM PERFORMANCE

The Pro Stock / Pro Mod body reigns as the preferred choice for top drag racers, meticulously engineered to deliver maximum performance on the drag strip, making it the ultimate selection for those seeking speed, precision & winning results.





- » Available in 3 composite blends:
- » **LIGHTWEIGHT COMPOSITE:** Body weighs under 80 lbs.
- » **CARBON FIBER:** Body weighs under 70 lbs.
- » **ULTRA LIGHT CARBON FIBER:** Body weighs under 60 lbs.
- » Fits 105" to 115" wheelbase chassis
- » Gray ready to paint finish on all parts

CAMARO BODY PANELS & OPTIONS

CARBON FIBER BODY PANELS SOLD THROUGH CHEVROLET PERFORMANCE

» **BILL SCHEMERS: 810.397.9688 EMAIL: BILL.S@TGIDIRECT.COM**

PRO STOCK BODY PACKAGES	LIGHTWEIGHT COMPOSITE		*CARBON FIBER		*ULTRA LIGHT CARBON FIBER	
Dash	64131-90012	\$684	N/A	N/A	N/A	N/A
Deck Lid	64131-31012	\$372	64131-31017	*CALL	64131-31018	*CALL
Door, left	64131-21012L	\$1,000	64131-21017L	*CALL	64131-21018L	*CALL
Door, right	64131-21012R	\$1,000	64131-21017R	*CALL	64131-21018R	*CALL
Front Clip, 1-piece UP TO 105" WHEELBASE, SCOOPED	64132-43012	\$3,380	64132-43017	*CALL	64132-43018	*CALL
Front Clip, 1-piece UP TO 105" WHEELBASE, EFI	64132-43012-2	\$3,380	64132-43017-2	*CALL	64132-43018-2	*CALL
Rear Clip, 1-piece	64131-51712	\$4,061	64131-51717	*CALL	64131-51718	*CALL
Spoiler, Spill Plates	913-6700-SP	\$214	CCS0604-SP	\$341	N/A	N/A
Spoiler, Wing	XC 962-6700L-W	\$379	XC 962-6700C-W	\$454	XC 962-6700U-W	\$466
PRO STOCK BODY PACKAGE PRICE	64131-10312	\$11,090	64131-10317	*CALL	64131-10318	*CALL

PRO MOD BODY PACKAGES	LIGHTWEIGHT COMPOSITE		*CARBON FIBER		*ULTRA LIGHT CARBON FIBER	
Dash	64131-90012	\$684	N/A	N/A	N/A	N/A
Deck Lid	64131-31012	\$372	64131-31017	*CALL	64131-31018	*CALL
Door, left	64131-21012L	\$1,000	64131-21017L	*CALL	64131-21018L	*CALL
Door, right	64131-21012R	\$1,000	64131-21017R	*CALL	64131-21018R	*CALL
Front Clip, 1-piece UP TO 115" WHEELBASE, SCOOPED	65132-43012	\$3,499	65132-43017	*CALL	65132-43018	*CALL
Front Clip, 1-piece UP TO 115" WHEELBASE, EFI	65132-43012-2	\$3,499	65132-43017-2	*CALL	65132-43018-2	*CALL
Rear Clip, 1-piece	64131-51712	\$4,061	64131-51717	*CALL	64131-51718	*CALL
Spoiler, Spill Plates	913-6700-SP	\$214	CCS0604-SP	\$341	N/A	N/A
Spoiler, Wing	XC 962-6700L-W	\$379	XC 962-6700C-W	\$454	XC 962-6700U-W	\$466
PRO MOD BODY PACKAGE PRICE	65131-10312	\$11,209	65131-10317	*CALL	65131-10318	*CALL

IMPORTANT: Lead times may vary. Price does not include shipping or the additional crating fees applied at time of purchase for complete bodies.

PRO STOCK / PRO MOD WINDOWS & HEADLIGHT LENS COVERS

Windshield, molded, mar-resistant coated, 3/16", OVERSIZED	64131-63302	\$379
Windshield, molded, mar-resistant coated, 3/16", cut to fit, beveled	64131-63332	\$406
Windshield, molded, mar-resistant coated, 1/8", OVERSIZED	64131-63202	\$353
Windshield, molded, mar-resistant coated, 1/8", cut to fit, beveled	64131-63232	\$383
Door Window, molded, mar-resistant coated, 1/8", OVERSIZED, left or right	64131-62202LorR	\$144 ea
Door Window, molded, mar-resistant coated, 1/8", cut to fit, beveled, left or right	64131-62232LorR	\$176 ea
Door Window, molded, mar-resistant coated, .093", OVERSIZED, left or right	64131-62102LorR	\$121 ea
Door Window, molded, mar-resistant coated, .093", cut to fit, beveled, left or right	64131-62132LorR	\$145 ea
Quarter Window, molded, mar-resistant coated, 1/8", cut to fit, beveled, drilled, left or right	64131-65242LorR	\$42 ea
Quarter Window, molded, mar-resistant coated, .093", cut to fit, beveled, drilled, left or right	64131-65142LorR	\$40 ea
Rear Window, molded, mar-resistant coated, 1/8", cut to fit, beveled, drilled	64131-61242	\$342
Rear Window, molded, mar-resistant coated, .093", cut to fit, beveled, drilled	64131-61142	\$264
Headlight Lens Covers, molded, mar-resistant coated polycarbonate, pair	60132-68142	\$59

VINYL NOSE & TAIL ID GRAPHIC ID KITS FOR A REALISTIC DEM LOOK!

PRINTED ON OUTDOOR DURABLE HIGH-TACK VINYL • GLOSSY LAMINATED SURFACE PROVIDES EXCELLENT PROTECTION

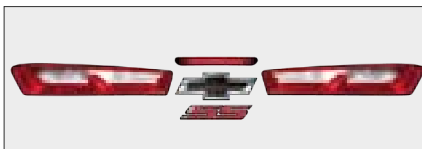

CHEVROLET CAMARO

Nose ID	60131-44142	\$36
Tail ID	60131-44542	\$30

» **FOR OLDER CAMARO PRO STOCK BODY PANELS, VISIT FIVESTARBODIES.COM**

MUSTANG BODY PANELS & OPTIONS

HOW TO ORDER YOUR BODY IN 3 QUICK & EASY STEPS

» 1. SELECT BODY TYPE » 2. SPECIFY WITH OR WITHOUT SCOOP » 3. SELECT MATERIAL

PRO STOCK BODY PACKAGES	LIGHTWEIGHT COMPOSITE		CARBON FIBER		ULTRA LIGHT CARBON FIBER	
Dash	960-900L	\$684	N/A	N/A	N/A	N/A
Deck Lid	64321-31012	\$372	64321-31017	\$379	64321-31018	\$439
Door, left	64321-21012L	\$997	64321-21017L	\$1,076	64321-21018L	\$1,157
Door, right	64321-21012R	\$997	64321-21017R	\$1,076	64321-21018R	\$1,157
Front Clip, 1-piece UP TO 105" WHEELBASE, SCOOPED	64321-43012	\$3,133	64321-43017	\$4,085	64321-43018	\$4,754
Front Clip, 1-piece UP TO 105" WHEELBASE, EFI	64321-43012-2	\$3,133	64321-43017-2	\$4,085	64321-43018-2	\$4,754
Rear Clip, 1-piece	64321-51712	\$4,255	64321-51717	\$5,177	64321-51718	\$6,170
Spoiler, Spill Plates	913-6700-SP	\$214	CCS0604-SP	\$341	N/A	N/A
Spoiler, Wing	64321-48012	\$389	64321-48017	\$445	64321-48018	\$486
PRO STOCK BODY PACKAGE PRICE	64321-10312	\$11,041	64321-10317	\$12,579	64321-10318	\$14,163

PRO MOD BODY PACKAGES	LIGHTWEIGHT COMPOSITE		CARBON FIBER		ULTRA LIGHT CARBON FIBER	
Dash	960-900L	\$684	N/A	N/A	N/A	N/A
Deck Lid	64321-31012	\$372	64321-31017	\$379	64321-31018	\$439
Door, left	64321-21012L	\$997	64321-21017L	\$1,076	64321-21018L	\$1,157
Door, right	64321-21012R	\$997	64321-21017R	\$1,076	64321-21018R	\$1,157
Front Clip, 1-piece UP TO 115" WHEELBASE, SCOOPED	65321-43012	\$3,133	65321-43017	\$4,085	65321-43018	\$4,754
Front Clip, 1-piece UP TO 115" WHEELBASE, EFI	65321-43012-2	\$3,133	65321-43017-2	\$4,085	65321-43018-2	\$4,754
Rear Clip, 1-piece	64321-51712	\$4,255	64321-51717	\$5,177	64321-51718	\$6,170
Spoiler, Spill Plates	913-6700-SP	\$214	CCS0604-SP	\$341	N/A	N/A
Spoiler, Wing	64321-48012	\$389	64321-48017	\$445	64321-48018	\$486
PRO MOD BODY PACKAGE PRICE	65321-10312	\$11,041	65321-10317	\$12,579	65321-10318	\$14,163

IMPORTANT: Lead times may vary. Price does not include shipping or the additional crating fees applied at time of purchase for complete bodies.

PRO STOCK / PRO MOD WINDOWS & HEADLIGHT LENS & TAIL LIGHT COVERS TINTED WINDOWS AVAILABLE ON OUR WEBSITE

Windshield, molded, mar-resistant coated, 3/16", OVERSIZED	64321-63302	\$379
Windshield, molded, mar-resistant coated, 3/16", cut to fit, beveled	64321-63332	\$406
Windshield, molded, mar-resistant coated, 1/8", OVERSIZED	64321-63202	\$353
Windshield, molded, mar-resistant coated, 1/8", cut to fit, beveled	64321-63232	\$383
Door Window, molded, mar-resistant coated, 1/8", OVERSIZED, left or right	64321-62202LorR	\$144 ea
Door Window, molded, mar-resistant coated, 1/8", cut to fit, beveled, left or right	64321-62232LorR	\$176 ea
Door Window, molded, mar-resistant coated, .093", OVERSIZED, left or right	64321-62102LorR	\$121 ea
Door Window, molded, mar-resistant coated, .093", cut to fit, beveled, left or right	64321-62132LorR	\$145 ea
Quarter Window, molded, mar-resistant coated, 1/8", cut to fit, beveled, drilled, left or right	64321-65242LorR	\$121 ea
Quarter Window, molded, mar-resistant coated, .093", cut to fit, beveled, drilled, left or right	64321-65142LorR	\$88 ea
Rear Window, molded, mar-resistant coated, 1/8", cut to fit, beveled, drilled	64321-61242	\$341
Rear Window, molded, mar-resistant coated, .093", cut to fit, beveled, drilled	64321-61142	\$242
Headlight Lens Covers, molded, mar-resistant coated polycarbonate, pair	60321-68142	\$59
Tail Light Covers, composites	64321-45417	\$275

VINYL NOSE & TAIL ID GRAPHIC ID KITS FOR A REALISTIC OEM LOOK!

PRINTED ON OUTDOOR DURABLE HIGH-TACK VINYL • GLOSSY LAMINATED SURFACE PROVIDES EXCELLENT PROTECTION



FORD MUSTANG

Nose ID	60321-44141	\$49
Tail ID	64321-44541	\$30

PRICING SUBJECT TO CHANGE WITHOUT NOTICE

ABC LMSC TRUCK RAV/MODIFIED OUTLAW/LATE MODEL SPORTSMAN STREET STOCK MOD3 LATE MODEL MOD3 MODIFIED DIRT GRAND NATL TAZ PRO STOCK/MOD FUNNY CAR WINDOWS ACCESSORIES

PRO STOCK

BODY DIMENSIONS

NO.	LOCATION	DETAILS	CHEVROLET CAMARO SS	FORD MUSTANG
1.	Front Overhang	Measured from long side of wheelbase center to front edge of body (splitter not included)	45.00	45.00 max
2.	Width	Over spindle	64.75	64.75
3.	Front Fascia Width	Measured across the front end at upper/outer corners of headlight recessed area	51.00	30.875
4.	Windshield Length Center	Measured from top center of windshield down to rear of hood/cowl center	20.25 min	24.50 min
5.	Overall Height	Measurement taken from the highest point of roof to rear of rocker	44.00 min	44.00
6.	Width (at B-Post)	Measurement taken 15" up from bottom of rocker, +/-0.25"	65.75	65.00
7.	Roof Length		58.625	45.25
8.	Side Window Height	Measurement taken at tallest point	12.125	14.00
9.	Door Length	Measurement taken at upper body line	56.375	53.375
10.	Rear Window Length		27.25	35.75
11.	Deck Lid Length	Measurement taken from bottom of rear window center	18.125	19.75
12.	Deck Lid Width	Measurement taken across rear of deck lid	47.75	45.50
13.	Spoiler Length	Length does not include wicker height. Minimum 0.75" height for wicker. Must be 90°	14.00	14.00
14.	Windshield Length	Measurement taken 12" inward from bottom corner of windshield. From this point, go to top of windshield, parallel to center line of body	26.25 min	28.50 min
15.	Spill Plate Height	+/-0.125"	6.00	6.00
16.	Section of Spill Plate above Spoiler	+/-0.125"	1.00	1.00
17.	Spill Plate Extension past rear of Spoiler		2.00 max	2.00 max
18.	Width in Front of Front Tire	Measurement taken at bottom of opening. +/-0.25"	62.50	62.125
19.	Width Behind Front Tire	Measurement taken 10" from front of rocker. +/-0.25"	63.625	64.25
20.	Width at Front Edge of Door	Measurement taken at widest point, +/-0.25"	65.50	65.25
21.	Width in Front of Rear Tire	Measurement taken at bottom of rocker. +/-0.25"	65.75	65.50
22.	Width Behind Rear Tire	Measurement taken at bottom of panel, widest point, +/-0.25"	61.50	60.875
23.	Width at Center of Rear Axle	+/-0.25"	66.25	67.25
24.	Rear Overhang	Measurement taken from the center of the rear axle to the center of bumper at furthest point above wheelie bar opening, +/-0.25"	48.25	49.25
25.	Length Left Hand Side	Measurement taken from rear of rocker to front edge of front wheel opening. +/-0.25"	100.50	102.125
26.	Length Right Hand Side	Measurement taken from rear of rocker to front edge of front wheel opening. +/-0.25"	99.125	100.875
27.	Wheelbase - Max		105.00	105.00
28.	Wheelbase - Min		104.00	104.00
29.	B-Post to Centerline of rear axle	+/-0.25"	21.50	22.00
30.	Splitter Length	Amount of 2.375" Total length front splitter mounted in front of body (see NHRA rulebook for more info)	0.375	0.375
31.	Length of Spill Plate		26.00 max	26.00 max
32.	B-Post Location	Measurement taken from bottom of rocker	15.00	15.00

FIVE STAR BODIES ARE DESIGNED TO MAINTAIN PRECISE FIT WITH OPTIMIZED AERODYNAMICS!

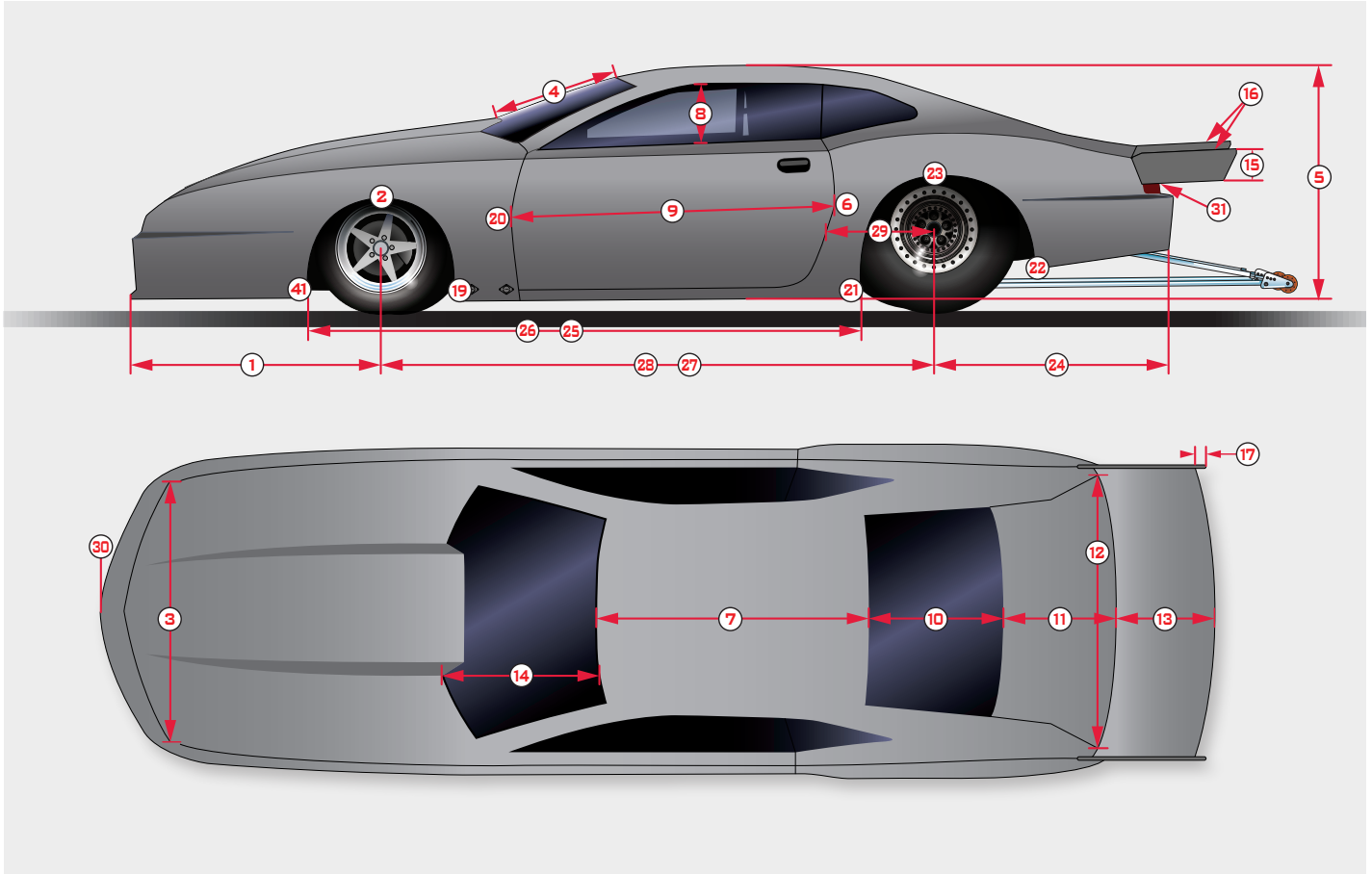

»» DOWNLOAD OFFICIAL RULEBOOK @ NHRACER.COM

HAVE A TECH QUESTION? THE NHRA ALSO HAS RESOURCES FOR ALL NHRA DIVISIONS TO ANSWER YOUR QUESTIONS ABOUT SAFETY, RULES, AND COMPLIANCE. VISIT NHRACER.COM!



TEMPLATE SETS ENSURE A CORRECT FIT FOR OPTIMUM AERODYNAMICS

- » Complete template set ensures body is installed correctly
- » Made from high-quality aluminum to maintain shape
- » Purchase complete set or Body/Nose Centerline only

Template Set, Ford, Complete, aluminum (ADDITIONAL CRATING CHARGE FOR FREIGHT SHIPMENT)	60321-82033	\$834
Template Set, Chevrolet, Complete, aluminum (ADDITIONAL CRATING CHARGE FOR FREIGHT SHIPMENT)	60132-82033	\$712
Template, Nose/Body Centerline, Chevrolet, aluminum	60132-82133	\$331

PRO STOCK / PRO MOD

FEATURED PRODUCTS



WINDOW INSTALLATION KIT

- » Provides the perfect fit and helps to increase the life of your window
- » Black oxide coated to prevent rust
- » This kit has enough hardware to install a complete set of windows on one car
- » Kit includes: 120 6-32 1/2" & 16 6-32 3/4" flat head socket screws, 136 6-32 nylon locknuts, 1 long-arm hex key and 9/64" drill bit

Window Installation Kit	805	\$23
-------------------------	-----	------



VINYL NOSE & TAIL ID GRAPHIC ID KITS

Built to withstand the rigors of the racetrack, our vinyl graphics are made from high-quality materials that resist fading, cracking, and peeling. They maintain their brilliant appearance even under the harshest conditions.

- » **HIGH-TACK ADHESION:** Our outdoor high-tack vinyl ensures that your graphics stay securely in place
- » **EXTREME DURABILITY:** Glossy laminated surface provides excellent protection under the harshest conditions
- » **EASY APPLICATION:** Installing our graphics is a breeze. With our easy-to-follow application instructions and the use of professional-grade vinyl, you can achieve a smooth, bubble-free finish that looks like it was applied by a pro!
- » Ordering info on pages 108 & 109

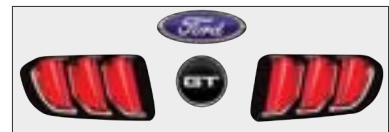
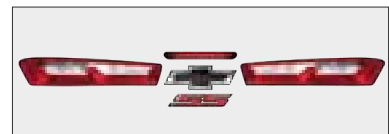

PREMIUM CARBON FIBER FLAT SHEETS



- » True cosmetic carbon fiber surface finish
- » Flat sheets allow you to custom fit your needs
- » Very high strength to weight ratio & heat tolerance
- » Excellent vibration damping characteristics
- » Laminated for additional strength & durability
- » Perfect for Interior accent panels

**2'x4' & 4'x8' FLAT SHEETS
READY TO CUT & FIT!**

STANDARD WEIGHT CARBON FIBER FLAT SHEETS

» Sheets laminated with 2 layer carbon fiber 1 layer woven fiberglass unless otherwise noted

090-04412	.040" thick, 2'x4'	\$171
090-00412	.040" thick, 4'x8' (1 LAYER CARBON FIBER 2 LAYER WOVEN FIBERGLASS)	\$673
090-00421	.040" thick, 4'x8'	\$740
090-00612	.062" thick, 4'x8'	\$771

LIGHTWEIGHT CARBON FIBER FLAT SHEETS

» Multi layer laminate consisting of 100% carbon fiber to create the lightest panel possible

090-04430	.040" thick, 2'x4'	\$213
090-00220	.028" thick, 4'x8'	\$634
090-00430	.040" thick, 4'x8'	\$797



TOP ALCOHOL FUNNY CAR

OFFICIAL GM LICENSED CHEVROLET CAMARO BODY

The perfect blend of speed and style, officially recognized for its authenticity & excellence in the world of drag racing.





» ALL CARBON FIBER CONSTRUCTED BODY:

- » Body mounting tabs laminated into the structure for ease of installation
- » Fits up to 125" wheelbase chassis
- » Weighs under 90 lbs
- » Body comes with a gray ready to paint surface finish

CAMARO FUNNY CAR BODY & WINDOWS

COMPLETE FUNNY CAR BODY SOLD THROUGH CHEVROLET PERFORMANCE

» BILL SCHEMERS: 810.397.9688 EMAIL: BILL.S@TGIDIRECT.COM

COMPLETE CAMARO FUNNY CAR BODY

Includes Tethered Burst Panel, & Escape Hatch	GM 88958780	*CALL
---	-------------	-------

REPLACEMENT PANELS & WINDOWS

Tethered Burst Panel	GM 88958780-B	\$518
Escape Hatch	GM 88958780-H	\$368
Spill Plate Set (INCLUDES LEFT & RIGHT SPILL PLATES & SPILL PLATE ANGLES)	GM 88958780-S	\$1,297
Parachute Boxes, pair (INCLUDES LEFT & RIGHT)	GM 88958780-P	\$661
Windshield, laminated, mar-resistant coated, .265", cut to fit, beveled, countersunk	68131-63558	\$920
Windshield, mar-resistant coated, 1/4", cut to fit, beveled	68131-63452	\$503
Windshield, mar-resistant coated, 3/16", cut to fit, beveled	68131-63352	\$441
Windows, Door, pair, mar-resistant coated, 1/8", cut to fit, beveled	68131-62252	\$242



UPGRADE TO FIVE STAR'S EXCLUSIVE LAMINATED WINDOW

- » Multi-layer laminated material deflects heavy impact for enhanced driver safety
- » High tech protective coatings applied
- » Similar thickness to monolithic (single-layer) polycarbonate windows
- » CNC machined and drilled for exact fit
- » The BEST OPTICAL QUALITY window available
- » Available exclusively from Five Star
- » Mandated windshield material used for all top NASCAR divisions

VINYL BODY ID GRAPHIC ID KITS FOR A REALISTIC DEM LOOK!

PRINTED ON OUTDOOR DURABLE HIGH-TACK VINYL • GLOSSY LAMINATED SURFACE PROVIDES EXCELLENT PROTECTION

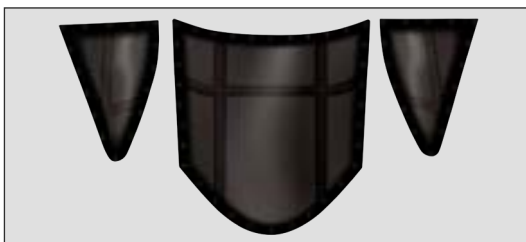

CHEVROLET CAMARO

Body ID Kit 68131-44382 \$74

KIT INCLUDES: NOSE, TAIL, SWEEPS, WINDOW BLACKOUTS



'15 CHEVROLET CAMARO

Body ID Kit 68131-44381 \$74

KIT INCLUDES: NOSE, TAIL, SWEEPS, WINDOW BLACKOUTS

PREMIUM CARBON FIBER FLAT SHEETS



- » True cosmetic carbon fiber surface finish
- » Flat sheets allow you to custom fit your needs
- » Very high strength to weight ratio & heat tolerance
- » Excellent vibration damping characteristics
- » Laminated for additional strength & durability
- » Perfect for interior accent panels

**2'x4' & 4'x8' FLAT SHEETS
READY TO CUT & FIT!**

STANDARD WEIGHT CARBON FIBER FLAT SHEETS

» Sheets laminated with 2 layer carbon fiber 1 layer woven fiberglass unless otherwise noted

090-04412	.040" thick, 2'x4'	\$171
090-00412	.040" thick, 4'x8' (1 LAYER CARBON FIBER 2 LAYER WOVEN FIBERGLASS)	\$673
090-00421	.040" thick, 4'x8'	\$740
090-00612	.062" thick, 4'x8'	\$771

LIGHTWEIGHT CARBON FIBER FLAT SHEETS

» Multi layer laminate consisting of 100% carbon fiber to create the lightest panel possible

090-04430	.040" thick, 2'x4'	\$213
090-00220	.028" thick, 4'x8'	\$634
090-00430	.040" thick, 4'x8'	\$797

CAMARO FUNNY CAR

BODY DIMENSIONS

NO.	MEASUREMENT LOCATION	MEASUREMENT
1.	Ground clearance; from leading edge of body to 12" behind centerline of front spindle	3" min
2.	Ground clearance; from 12" behind centerline of front axle to the rear of the car	2" min
3.	Vertical height; from centerline of spindle to wheel opening	5" min
4.	Front over hang; from leading edge of body to centerline of the front spindle	40" max
5.	Cowl height; in front of injector hat	5" max
6.	Injector opening width	26" max
7.	Body burst panel; in front of injector hat	288 in ² min
8.	Window height	OEM minus no more than 2"
9.	Fire extinguisher window opening; both sides	6" Diameter min
10.	Center or rear axle to trailing edge of rocker panel	18" min
11.	Vertical height from center line of rear axle to wheel opening	8" min
12.	Height; trailing edge of rear bumper to the ground	29" max
13.	Height; bumper vertical surface	3" min
14.	Wheelbase; right/passenger side: max 2" difference between	100" min / 125" max
15.	Wheelbase; left/driver side: max 2" difference between	100" min / 125" max
16.	Rear over hang; centerline of rear axle to trailing edge of rear bumper	54" max
17.	Bumper opening; for parachute shroud lines	30" x 4" max
18.	Roof width	32" min
19.	Roof length; top of front windshield to top of rear window	OEM +/- 4"
20.	Escape hatch length	18" min
21.	Escape hatch width	17" min
22.	Body width; at centerline of front axles - max difference 6"	60" min
23.	Body width; at centerline of rear axles - max difference 6"	60" min
24.	Spoiler width; outside	54" max
25.	Spoiler over hang; centerline of rear axle to trailing edge of spoiler	56" max
26.	Spoiler height; above top of roof; may not be above spill plates	4" max
27.	Spill plate height; above top roof	5" max
28.	Lip around body; fenders, bumpers, rocker panels	1" max
29.	Hinged tail light openings	100 in ² max each side
30.	Spill plate over hang; centerline of rear axle to trailing edge of spill plates	60" max
31.	Rear deck between spill plates; depth below rear deck outside spill plates	1.75" max
32.	Top of spill plate to ground; height	60" max

FIVE STAR BODIES ARE DESIGNED TO MAINTAIN PRECISE FIT WITH OPTIMIZED AERODYNAMICS!

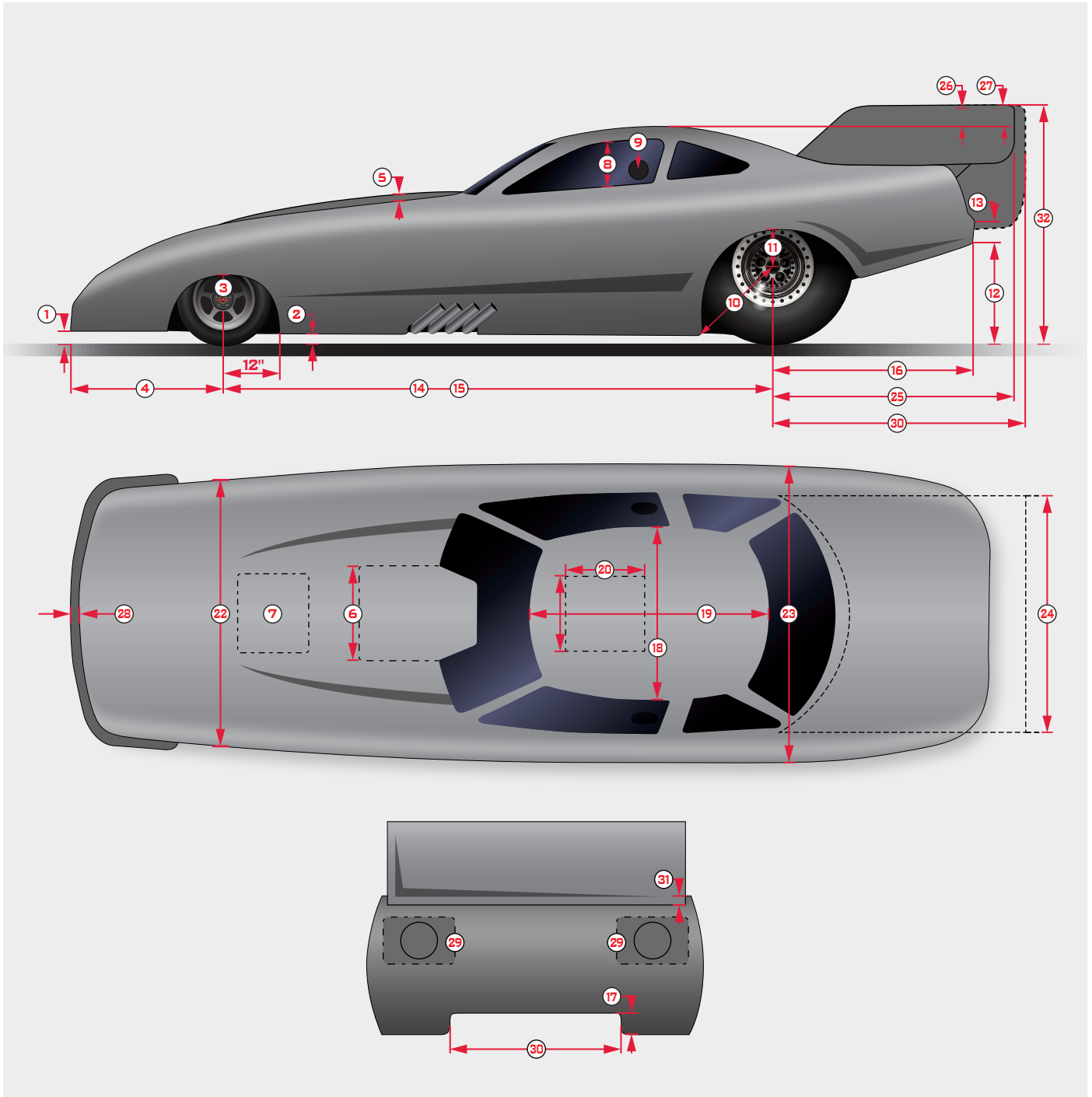

» DOWNLOAD OFFICIAL RULEBOOK @ NHRACER.COM

HAVE A TECH QUESTION? THE NHRA ALSO HAS RESOURCES FOR ALL NHRA DIVISIONS TO ANSWER YOUR QUESTIONS ABOUT SAFETY, RULES, AND COMPLIANCE. VISIT NHRACER.COM!



PRICING SUBJECT TO CHANGE WITHOUT NOTICE

ABC LMSC TRUCK RAY/MODIFIED OUTLAW/LATE MODEL SPORTSMAN STREET STOCK M3 LATE MODEL M3 MODIFIED DIRT GRAND NATL TAZ PRO STOCK/MOD FUNNY CAR WINDOWS ACCESSORIES



RACING WINDOWS

THE #1 WINDOWS IN MOTORSPORTS

Explore the widest variety of racing windows in the industry, the list of options is endless! If you don't find what you are looking for, see our custom window section and build your own!





**SHOP FOR OUR COMPLETE LINE OF WINDOWS
ON OUR WEBSITE OR OR SCAN THE QR CODES:**

UNIVERSAL



AFTER MARKET

DRAG RACING



AFTER MARKET

FACTORY



STOCK

PREMIUM RACING WINDOWS

FEATURES & OPTIONS

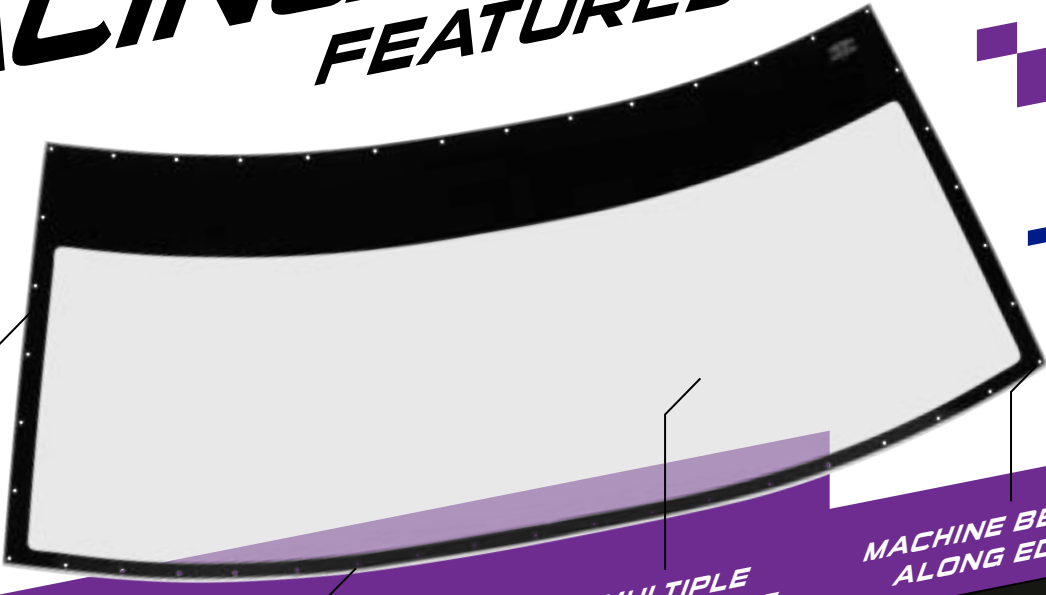

BLACK-OUT BORDER



DRILLED & COUNTERSUNK



MULTIPLE THICKNESSES

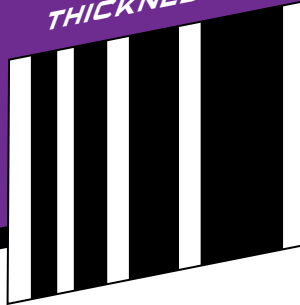

MACHINE BEVELED ALONG EDGES

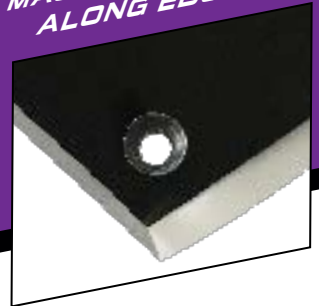

MATERIAL:

- » Two Monolithic Polycarbonate options:
 - » Clear - 100% Light Transmission
 - » Tinted - 18% Light Transmission
- » Five Star SafeGuard Laminated Polycarbonate Thickness: 0.093" • 1/8" (0.118") • 3/16" (0.177") • 1/4" (0.236")

COATED OR UNCOATED:

- » Mar-Resistant Coated or Uncoated (Economy)
- » Coated windows last longer and save you money over time
- » Uncoated polycarbonate is cheaper but offers no protection against scratching, hazing, and the damaging effects of UV. Plus, cleaning an uncoated window can cause scratch marks that affect visibility.

EDGE TREATMENT:

- » Edges can be machine beveled and will fit exactly into the window frame

CUT:

- » Oversize: Typically cut 1-1/2 inches larger than the window frame; requires cutting, trimming, beveling and drilling
- » Precut to Fit: Straight-cut to fit exactly into the window frame

INSTALLATION OPTIONS:

- » Option 1: Installation holes are pre-drilled.
- » Option 2: Installation holes are pre-drilled & countersunk

BLACK-OUT BORDER:

- » Professional appearance is printed with ultra-durable, high-quality, scratch-resistant and non-flaking permanent ink.
- » Black-out Borders are available on custom formed windows for higher-quantity production runs only.

BUILD YOUR OWN CUSTOM WINDOWS

» CALL OUR SALES TEAM AT 262.877.2171 FOR YOUR CUSTOM WINDOW NEEDS!

CUSTOM WINDOW SPECIFICATIONS

THESE TWO DIMENSIONS ARE NEEDED TO DETERMINE WHICH SHEET TO PURCHASE:

DIM A - THE HEIGHT: Place your window on end upon a level space with the roof edge down. Measure (DIM A), from the floor to the highest point

DIM B - THE WIDTH: Measure across the widest point (DIM B) to be sure that the width does not exceed 70"

- If DIM A is less than 39" use Sheet #1
- If DIM A is 39-47" use Sheet #2

MATERIAL	THICKNESS	SHEET #1	SHEET #2
Clear	.093"	\$317	\$363
Tint	.093"	N/A	\$436
Clear	.118" (1/8")	\$353	\$399
Tint	.118" (1/8")	N/A	\$479
Clear	.177" (3/16")	\$424	\$462
Clear	.236" (1/4")	\$505	\$616

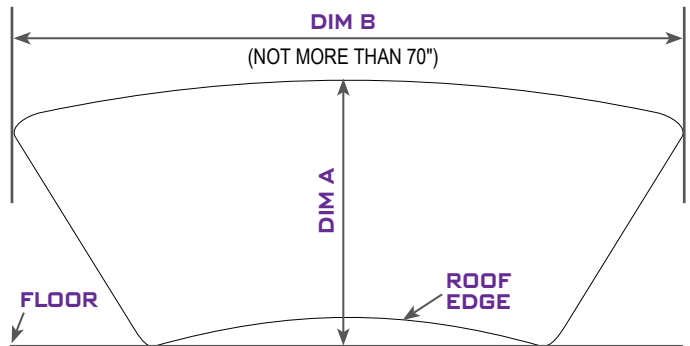

IMPORTANT INFORMATION:

- » Oversized molded sheets are typically 1-1/2" larger than stock (you cut it to fit)
- » Sheets are formed, not flat. Prices on this chart include all forming costs.
- » Contact our Five Star Sales team for complete ordering information, or to determine whether or not factory glass window is needed for tooling purposes

POLYCARBONATE FLAT SHEETS

MAR-RESISTANT FLAT SHEETS CANNOT BE THERMOFORMED! Tint is dark gray with 18% light transmission. Custom sheet sizes are available upon request, and with a minimum order quantity.

PART #	CLEAR/TINT	THICKNESS	SHEET SIZE	COATING	PRICE
000-6102	Clear	.093"	40" x 72"	uncoated	\$76
000-6112	Tint	.093"	40" x 72"	mar-resistant	\$171
000-6300	Clear	.118" (1/8")	24" x 48"	mar-resistant	\$73
000-6301	Clear	.118" (1/8")	32" x 72"	mar-resistant	\$132
000-6303	Clear	.118" (1/8")	36" x 72"	mar-resistant	\$158
000-6302	Clear	.118" (1/8")	40" x 72"	mar-resistant	\$175
000-6122	Tint	.118" (1/8")	40" x 72"	mar-resistant	\$210
000-6306	Clear	.118" (1/8")	72" x 96"	mar-resistant	\$422
000-6304	Clear	.177" (3/16")	36" x 72"	mar-resistant	\$211



POLYCARBONATE

FLAT SHEETS

» GO TO FIVESTARBODIES.COM TO SEE OUR FULL LINE OF WINDOWS!

PRICING SUBJECT TO CHANGE WITHOUT NOTICE

ABC LMSC TRUCK PAV MODIFIED OUTLAW LATE MODEL SPORTSMAN STREET STOCK M03 LATE MODEL M03 MODIFIED DIRT GRAND NATL T12 PRO STOCK/MOD FUNNY CAR WINDOWS ACCESSORIES



BODY MOUNTING TOOLS, BRACING & ACCESSORIES

*PRODUCTS ESSENTIAL FOR A COMPLETE, CLEAN,
PROFESSIONAL-LOOKING RACE CAR*



- » **MOUNTING TOOLS:** Facilitate a professional body installation, & replace panels throughout the season quick & hassle-free
- » **UNIVERSAL BRACING:** Support body panels with these lightweight components essential to achieving astounding aerodynamics
- » **ACCESSORIES:** Everything you need to give you race car that finishing touch!

FIVE STAR PREMIUM AVEX STYLE MULTI-GRIP RIVETS *THE BEST QUALITY ON THE MARKET*

- » Five Star Rivets have a super-tight grip & won't spin while drilling
- » Grip range of up to 3/16" for 1/8" rivets & up to 1/2" for 3/16" rivets
- » Use long shank rivets for fastening fender, door, & windshield post together
- » Sold in quantities of 100 & 500; large head & small head with choice of 1/8" unpainted or 3/16" unpainted, white, black, blue, red



SIZE/DESCRIPTION	QTY	SMALL	LARGE	
3/16", color	100	814x-100S	814x-100L	\$17
3/16", unpainted	100	816-100S	816-100L	\$17
3/16" long shank	100	816A-100S	N/A	\$19
3/16", color	500	814x-500S	814x-500L	\$68
3/16", unpainted	500	816-500S	816-500L	\$55
1/8", unpainted	100	815-100S	815-100L	\$13
1/8", unpainted	500	815-500S	815-500L	\$50

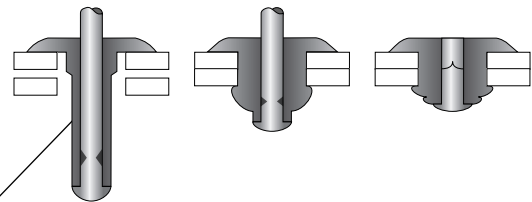

Provide a secure installation of your body panels with Five Star Rivets & Washers!

Five Star Rivets pull much tighter than other, cheaper rivets.

Washers are oversized to fit with Five Star Rivets and keep rivets tight no matter how much vibration

FIVE STAR PREMIUM WASHERS

- » Five Star Premium Washers are lightweight & available in 3 sizes
- » Recommended for all plastic & composite body panels to keep them tight & prevent rivets from pulling out

TYPE	SIZE (I.D.)	SIZE (O.D.)	QTY		
Standard	1/8"	3/8"	100	817-100A	\$9
Standard	1/8"	3/8"	500	817-500A	\$25
Standard	3/16"	1/2"	100	818-100A	\$9
Standard	3/16"	1/2"	500	818-500A	\$25
Large	3/16"	3/4"	100	818-100AL	\$9
Large	3/16"	3/4"	500	818-500AL	\$25

HIGH-IMPACT PLASTIC WEAR STRIPS

- » Height adjustable to seal the nose to the track to optimize aero & protection from wear
- » CNC-machined from Five Star's exclusive durable plastic
- » 2-piece kit fits either side
- » Install with Five Star Wear Strip Attach Kits
- » Available in 10 colors

ABC NextGen, NextGen LMSC Wear Strips	116" x 1-7/8"	11002-41551-x	\$35
ABC, LMSC, Straight-up Metal, Dirt Grand National Wear Strips	112" x 2-3/4"	000-400-x	\$35
S2 Sportsman Wear Strips	111" x 3"	664-400-x	\$42
Classic Street Stock (N/A IN FLUORESCENT COLORS)	120" x 5"	600-400-x	\$41
MD3 Street Stock, '88 Monte Carlo Wear Strips	119" x 3"	021-400-x	\$41
Modern Style Street Stock, North American Sportsman Wear Strips	107" x 3"	20002-41551-x	\$38

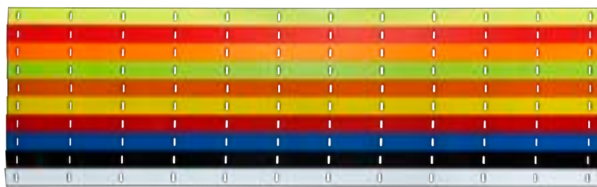

11002-41551-X



000-400-X

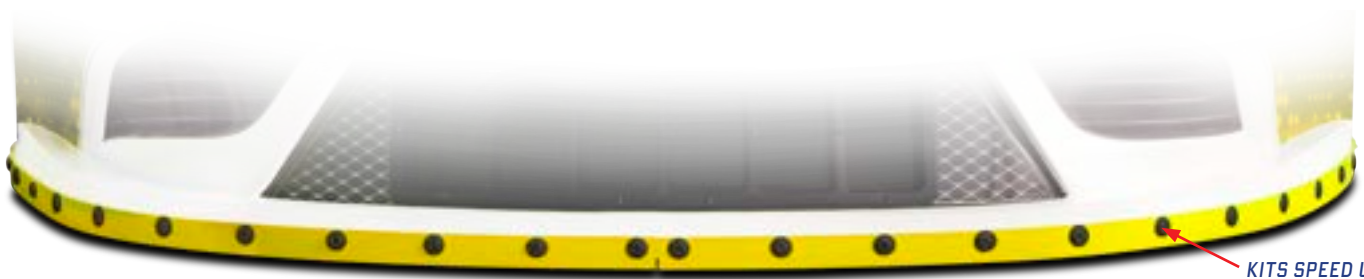

11002-41551-Y YELLOW WEAR STRIPS FULLY INSTALLED WITH 00001-72651 UNIVERSAL BODY MOUNTING KIT

KITS SPEED UP WEAR STRIP INSTALLATION & ALLOW FOR ADJUSTABILITY OF WEAR STRIP IF NEEDED



FULLY ASSEMBLED PLASTIC

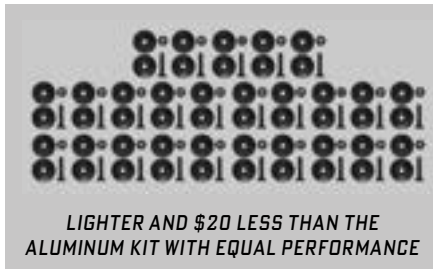

LIGHTER AND \$20 LESS THAN THE ALUMINUM KIT WITH EQUAL PERFORMANCE



FULLY ASSEMBLED ALUMINUM

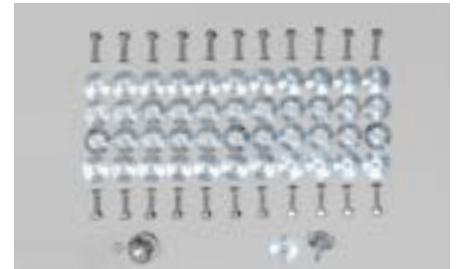

UNIVERSAL BODY MOUNTING KITS

- » Universal fit that can be used anywhere on a race car
- » Plastic Kit comes in all black & features Delrin washers that withstand repeated impact & stress
- » **Aluminum Kit includes:** 25 lightweight machined aluminum inner & outer 1" diameter washers, 25 nuts & 25 bolts. Kit weighs 12 oz
- » **Plastic Kit includes:** 25 ultra-durable plastic inner & outer 1" diameter washers, 25 lightweight aluminum nuts & 25 bolts.
- » Kit weighs 7 oz

Aluminum: 25 sets (FULL INSTALLATION)	000-400K	\$49
Plastic: 25 sets (FULL INSTALLATION)	00001-72651	\$29

FRONT BUMPERS

- » Formed using CNC progressive tube bending technology
- » Fits the exact contour of Five Star noses for maximum protection and ease of installation
- » Formed from 1-3/4" OD round steel tubing
- » For a complete secure mount, it is recommended to install your bumpers with Five Star's Front Bumper Mounting Kits

ABC NEXTGEN		
Front, .065" steel	11002-71182	\$48
Front, .095" steel	11002-71185	\$48
Front, .095" steel (12" EXT RIGHT SIDE)	11002-71188	\$56
NEXTGEN LMSC		
Front, .065" steel	13002-71182	\$48
Front, .095" steel	13002-71185	\$48
Front, .095" steel (12" EXT RIGHT SIDE)	13002-71188	\$56
ABC / LMSC / STRAIGHT-UP METAL		
Front, .065" steel	660-7103	\$48
Front, .095" steel	660-7103B	\$48
Front, .095" steel (12" EXT RIGHT SIDE)	660-7103C	\$56

NORTH AMERICAN SPORTSMAN		
Front .065" steel	20002-71182	\$48
STREET STOCK '88 MONTE CARLO		
Front, .065" steel	600-7103	\$48
Front, .095" steel	600-7103B	\$48
Front, .065" steel	600-7101 (SQUARE)	\$48
STREET STOCK CAMARO & MUSTANG		
Front, .065" steel	20002-71182	\$48
DIRT GRAND NATIONAL		
Front, .065" steel	700-7103	\$48
Front, .095" steel	700-7103B	\$48
SHORT TRACK TRUCK COMMON		
Front, .065" steel	21001-71162	\$48

FRONT BUMPER MOUNTING KIT (HIGHLIGHTED IN ORANGE)
WITH BLACK ADJUSTABLE BUMPER SUPPORTS

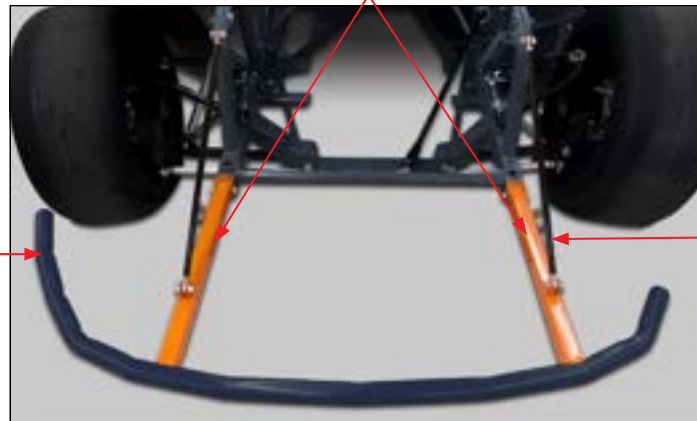

.095" STEEL BUMPER WITH
12" EXTENSION FOR
ADDITIONAL RIGHT FRONT
PROTECTION

CLOSE-UP OF
ADJUSTABLE
BUMPER SUPPORT

FRONT BUMPER MOUNTING KITS

- » Everything you need to mount the bumper to the chassis
- » Upgraded lightweight, extruded, black anodized aluminum adjustable bumper supports
- » Make quick, easy, & accurate adjustments with a 5/8" wrench
- » Universal design for all Five Star Short Track Noses
- » Fits all chassis configuration
- » **Complete Kit includes:** 2 aluminum threaded bumper support tubes; 4 clevis, eye bolts & nuts; 2 1-1/2" pieces of square tubing, notched on one end; 2 pieces of flat stock; 4 1-1/2" bolts & stover nuts, 2 pivoting chassis mounts with 2-1/2" bolts & nuts
- » **Adjustable Bumper Support Kit includes:** 2 extruded, threaded, black anodized aluminum adjustable tubes; 4 eye bolts & nuts; 4 1-1/2" bolts and stover nuts
- » **Replacement Kit includes:** 2 1-1/2" square pieces of square tubing; 2 pieces of flat stock; 1/2" nuts & bolts & mounting tabs

Complete Kit	10001-72721	\$132
Adjustable Bumper Support	10001-72733	\$29
Replacement Kit	802-4	\$87

10001-72721 | COMPLETE KIT

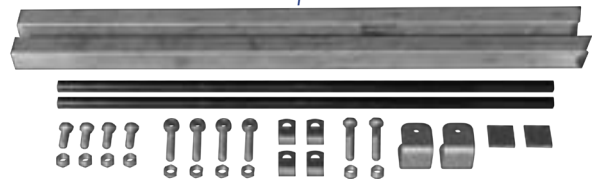

802-4 | REPLACEMENT KIT



10001-72733 | ADJUSTABLE BUMPER SUPPORTS KIT

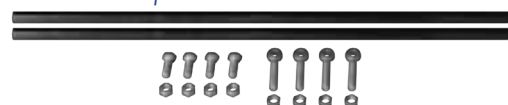

HOOD PIN BRACKETS

- » Preformed to fit the nose & hood precisely
- » Aluminum option weighs less than half of steel
- » Both options include welded-on tabs for hood pin placement
- » Aluminum bracket includes welded on mounting tabs on each end to brace to the front bumper mounting kit for added support
- » ABC NextGen / NextGen LMSC require 4 hood pins & Old Style ABC/LMSC require 5 hood pins
- » Available in 1/2" & 3/4" options, & will work for both 1/2" & 3/8" hood pins

ABC NEXTGEN / NEXTGEN LMSC:		
3/4" OD, aluminum (COMMON)	11002-34333	\$66
3/4" OD, steel (COMMON)	11002-34331	\$35
OLDER STYLE ABC / LMSC:		
3/4" OD, aluminum (EXCLUDES FORD)	660-411A-HPB	\$66
3/4" OD, aluminum (FORD)	570-411A-HPB	\$66
3/4" OD, steel (EXCLUDES FORD)	660-411-HPB	\$35
3/4" OD, steel (FORD)	570-411-HPB	\$35
1/2" OD, steel (EXCLUDES FORD)	660-410-HPB	\$35
1/2" OD, steel (FORD)	570-410-HPB	\$35
NORTH AMERICAN SPORTSMAN:		
3/4" OD, steel	20002-34331	\$35

S2 SPORTSMAN:		
3/4" OD, steel	664-411-HPB	\$35
1/2" OD, steel	664-410-HPB	\$35
SHORT TRACK TRUCK:		
1/2" OD, steel (COMMON)	21001-34131	\$35
STREET STOCK:		
3/4" OD, steel ('88 MONTE CARLO)	600-410-HPB	\$35
3/4" OD, steel (MD3 CAMARO & MUSTANG)	20002-34331	\$35
DIRT GRAND NATIONAL:		
1/2" OD, steel (EXCLUDES FORD)	700-410-HPB	\$35
1/2" OD, steel (FORD)	703-410-HPB	\$35

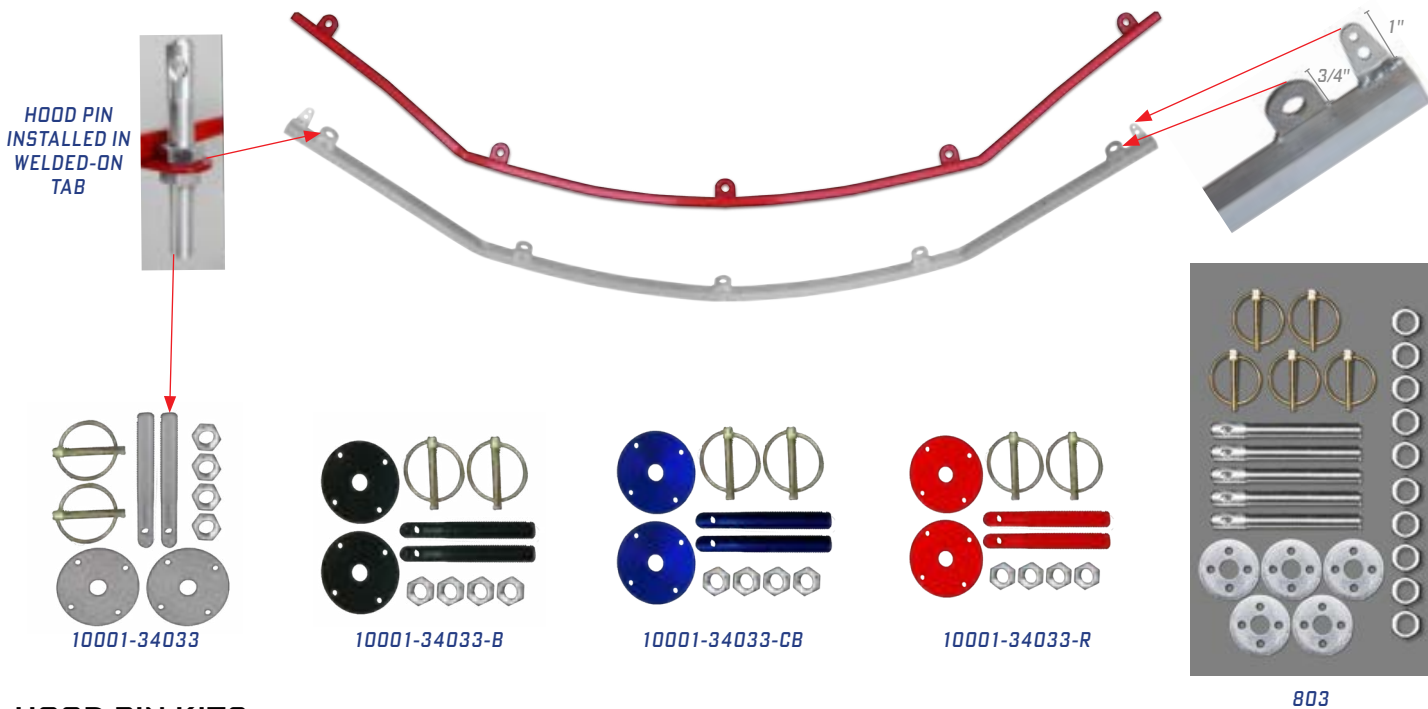

HOOD PIN KITS

- » **Secure your hood in style!**
- » **3/8" Hood Pin Kit:** 2 pack kit includes: 2 lightweight anodized & gun-drilled aluminum pins (HALF THE WEIGHT OF STANDARD), 2 aluminum scuff plates, 2 flip-over steel clips, 4 jam nuts
- » **1/2" Hood Pin Kit:** 5 pack kit includes: 5 lightweight aluminum pins, 5 aluminum scuff plates, 5 flip-over style steel clips, 10 jam nuts

3/8" Hood Pin Kit, Silver	10001-34033	\$15
3/8" Hood Pin Kit, Black	10001-34033-B	\$15
3/8" Hood Pin Kit, Red	10001-34033-R	\$15
3/8" Hood Pin Kit, Blue	10001-34033-CB	\$15
1/2" Hood Pin Kit, 5 pack	803	\$38
1/2" Scuff Plate, aluminum	803-PS	\$2



FULLY INSTALLED UNDERNEATH THE LOWER NOSE VALANCE (LEFT SIDE SHOWN)



ALUMINUM
11002-75733

42-1/2"

LOWER NOSE SUPPORT BRACKET

- » Mounts under the lower valance to maintain strength & structural integrity for the nose under high speeds
- » Choose from a lightweight aluminum or steel bracket
- » Fits left & right half of nose
- » **2-piece kit includes: 2 brackets with 2 attached mounting tabs for ease of installation**

Aluminum	11002-75733	\$49
Steel	11002-75731	\$44

FITS THESE BODY STYLES: ABC NEXTGEN, NEXTGEN LMSC



000-500: MOUNT TO INSIDE OF WEAR STRIPS WITH A FIVE STAR UNIVERSAL BODY MOUNTING KIT



11002-75333: MOUNT VERTICALLY ON NOSE SIDE

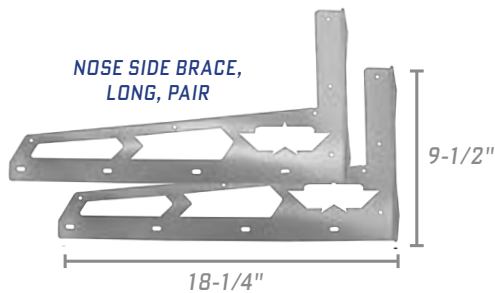

NOSE SIDE BRACE,
LONG, PAIR

18-1/4"

9-1/2"

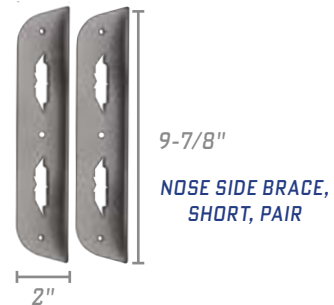

9-7/8"

NOSE SIDE BRACE,
SHORT, PAIR

2"

ALUMINUM NOSE SIDE BRACES

- » Provides structure to an aero critical part of the car
- » Laser-cut aluminum is pre-drilled for riveting to the nose & for mounting body braces
- » Works great with Five Star's Premium Adjustable Body Braces (PN 10001-759XX)
- » Each pair weighs less than a pound

Nose Side Brace, Long, pair	000-500	\$39
FITS THESE BODY STYLES: OLDER STYLE ABC AND OLDER STYLE LMSC, FIBERGLASS SPORTSMAN, STRAIGHT UP METAL, DIRT GRAND NATIONAL, MINI STOCK MUSTANG		
Nose Side Brace, Short, pair	11002-75333	\$14

FITS THESE BODY STYLES: ABC NEXTGEN, NORTH AMERICAN SPORTSMAN, NEXTGEN LMSC, SHORT TRACK TRUCK

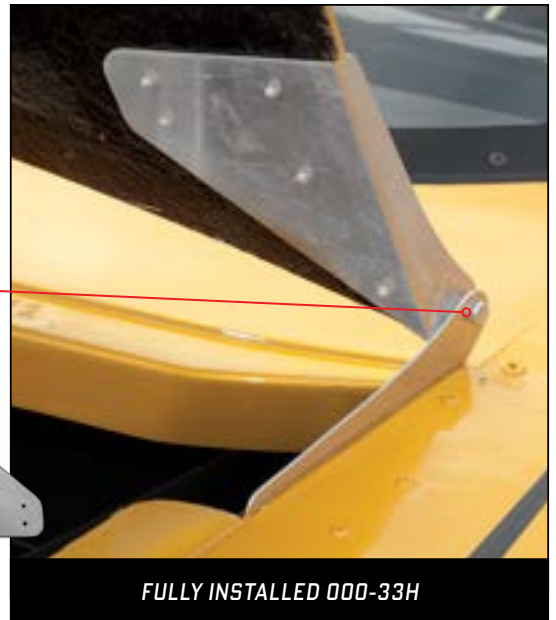
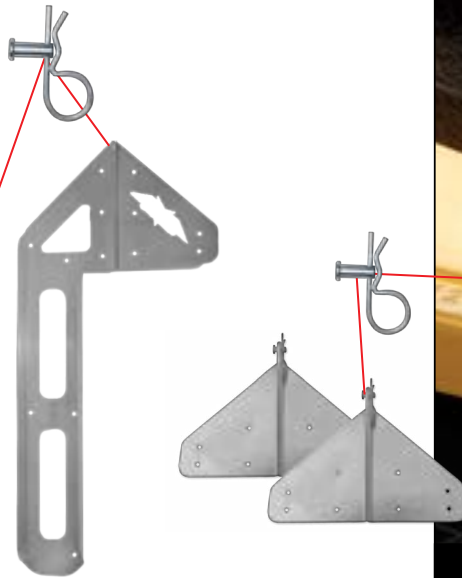

ALUMINUM HOOD HINGE KITS

- » Hinged hoods create easy access to the engine compartment
- » Long Hinge Kit includes: Laser cut aluminum hinge, pin, & clip assembly. 1 kit is required to complete the installation of a hood
- » Short Hinge Kit includes: Laser cut aluminum hinge, pin, & clip assembly. 2 kits are required to complete the installation of a hood

Hood Hinge, short	000-33H	\$16
Hood Hinge, long	11002-73333	\$39
Replacement Pin & Clip	000-33HP	\$4

ALUMINUM HOOD PROP

- » Makes for the easiest access to the engine compartment
- » Made of machined lightweight aluminum
- » Used for hinged hoods
- » Sold as a pair, 2 needed for installation

Hood Prop, pair	000-3400	\$67
-----------------	----------	------

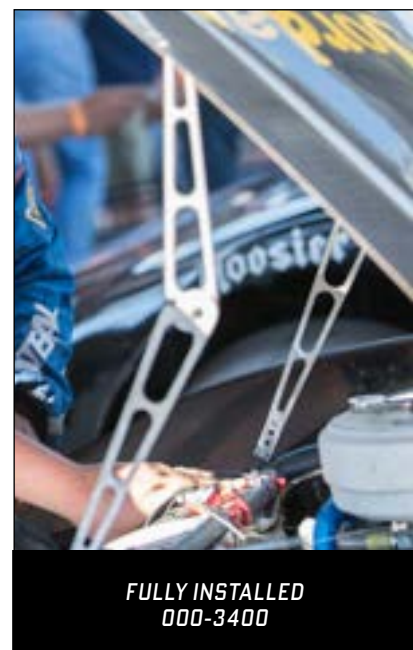

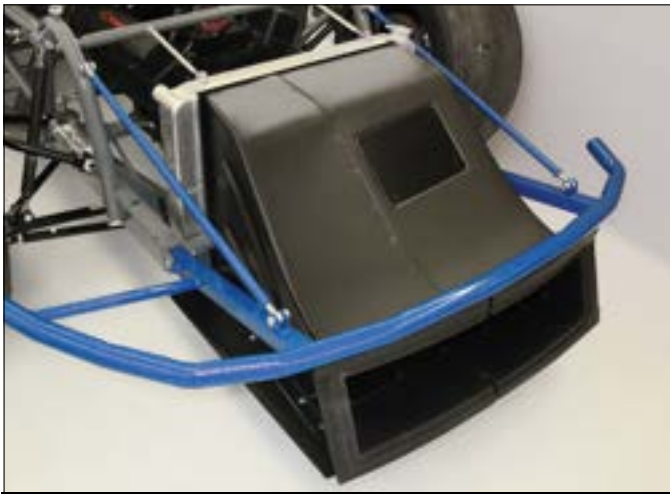

000-408 FULLY INSTALLED

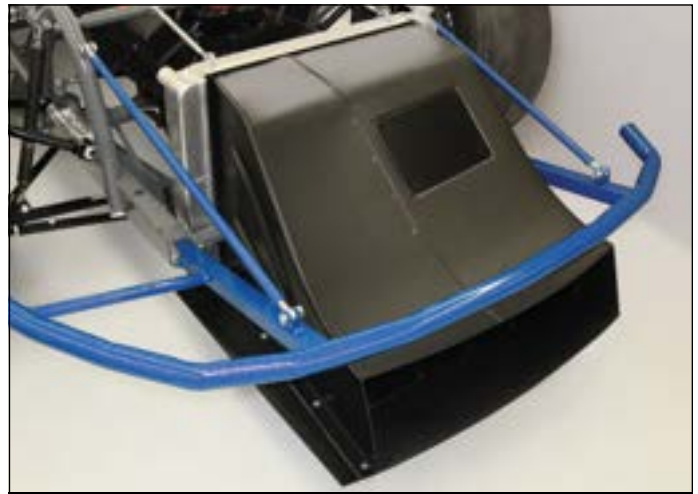

11002-42151 FULLY INSTALLED

MOLDED PLASTIC RADIATOR DUCTS

- » Universal multi piece design for easy installation to fit any chassis and radiator size/offset
- » High air flow design
- » Premium molded plastic weighs less than 13 lbs
- » More durable and easier to install than other sheet metal air boxes
- » 100% positive seal from nose to radiator
- » Access panel for easy debris clean-out
- » 000-408 for short track bodies, includes Plastic Nose Air Inlet Extension
- » The Plastic Nose Air Inlet Extension is not needed for the ABC NextGen & Late Model Stock Car NextGen

Universal Short Track Bodies*	000-408	\$221
ABC NextGen / NextGen LMSC	11002-42151	\$185

*FITS THESE BODY STYLES: ABC, LMSC, NORTH AMERICAN SPORTSMAN, S2 SPORTSMAN, STRAIGHT-UP METAL, STREET STOCK



***NOTE: FOR COMPLETE INSTALLATION GUIDE VISIT FIVESTARBODIES.COM/RESOURCES**

PLASTIC BRAKE DUCT KIT

- » Provide peak airflow to cool your brakes
- » Universal fit for all noses at correct angle; fits either side
- » Fits 3" & 4" Brake Duct hose
- » **Kit includes:** pre-cut stainless steel screen, rivets & washers
- » Weighs 6 oz

Brake Duct	000-412D	\$35
------------	----------	------

FITS THESE BODY STYLES: ABC NEXTGEN, ABC, NEXTGEN LMSC, LMSC, S2, SHORT TRACK TRUCK, NORTH AMERICAN SPORTSMAN, STRAIGHT-UP METAL, STREET STOCK

ONLY WEIGHS 6 OZ





000-409 FULLY INSTALLED



STREET STOCK
FLEXIBLE RADIATOR DUCT

FLEXIBLE RADIATOR DUCTS

- » Retains air flow functionality even after frontal impact & reduces the risk of radiator damage
- » Flexible Radiator Duct replaces rigid metal ductwork with a custom canvas bag & aluminum or plastic framing
- » Long lasting & durable
- » Simple installation
- » Select your model by measuring the size of the radiator core
- » Features molded plastic radiator mounting flanges
- » Plastic Nose Air Inlet Extension (PN 000-409-NP) used for 000-409 Radiator Ducts only

Street Stock (PN 600-409)

- » Fits both '88 Monte Carlo Noses
- » Captures air from both the upper & lower nose grill openings

ABC/NORTH AMERICAN SPORTSMAN/S2/SU		STYLE/SIZE	ABC NEXTGEN/NEXTGEN LMSC	
000-409-1	\$169	Griffin, 22-3/8" x 17-7/8"	11002-42120	\$135
000-409-2	\$169	Howe, 24-1/4" x 18-1/2"	11002-42121	\$135
000-409-3	\$169	Howe, 22-1/4" x 18-3/4"	11002-42122	\$135
000-409-4	\$169	C & R, 22-1/4" x 17-3/4"	11002-42123	\$135
000-409-5	\$169	C & R, 24-1/4" x 17-3/4"	11002-42124	\$135
000-409-6	\$169	Howe, 27-1/4" x 18-1/2"	11002-42125	\$135
LMSC		STYLE/SIZE	STREET STOCK	
000-409-5	\$169	C & R, 24-1/4" x 17-3/4"	11002-42124	\$135
000-409-6	\$169	Howe, 27-1/4" x 18-1/2"	11002-42125	\$135

PLASTIC NOSE AIR INLET EXTENSION

- » Ideal for racers who build their own aluminum radiator box
- » Molded Plastic construction & weighs less than 2 lbs
- » The Plastic Nose Air Inlet Extension is not needed for the ABC NextGen & Late Model Stock Car NextGen
- » Item already included with 000-408 Molded Plastic Radiator Duct & 000-409 Flexible Radiator Duct

Plastic Nose Air Inlet Extension	000-409-NP	\$36
----------------------------------	------------	------

FITS THESE BODY STYLES: ABC, LMSC, NORTH AMERICAN SPORTSMAN, S2 SPORTSMAN, STRAIGHT-UP METAL



SHOWN MOUNTED FROM INSIDE OF NOSE

DETAILS AND



DIMENSIONS



FULLY INSTALLED COLD AIR BOX

COWL INDUCTION COLD AIR BOXES

FLOW BENCH TESTED FOR PEAK AIRFLOW

- » Advanced lightweight composite construction with flame retardant gray resin
- » Comparable in weight to carbon fiber alternatives
- » Designed for maximum airflow using air filters as short as 3"
- » Increased distributor & under hood clearance
- » Fits a standard 14" filter element

4 Barrel, 0° Angle (Offset)	10001-53401	\$568
4 Barrel, 3° Angle (Standard)	10001-53431	\$568
2 Barrel, standard	10001-53201	\$426
2 Barrel, offset	10001-53202	\$406

NOTE: FOR OLDER STYLE 51-SERIES COLD AIR BOXES CALL FIVE STAR 262.877.2171



2 BARREL COLD AIR BOX

4 BARREL AIR BOXES:

- » Available in 0° & 3° to ensure a proper, level fit
- » Feature a patented machined adapter ring for clean airflow, better fit, & durability
- » 3° Airbox is commonly used for short track Late Models
- » How to determine air box angle option:
 - » Set car at proper ride height
 - » Place angle finder on carburetor to determine which air box option fits bests



4 BARREL COLD AIR BOX

2 BARREL OFFSET AIR BOX:

- » Offset 2-barrel air box is for engines with a larger setback
- » Designed to allow the element to be flat across the back for engine setback & clearance in the cowl
- » Fits a standard 3-1/2" x 14" filter element

2 BBL AIR BOX IS DYNO TESTED

"The results were outstanding! Five Star's 2bbl Air Box was 10 HP & 16 ft lbs of torque better than the old one!"

-SHANE HARDING
HARDING MOTORSPORTS CHASSIS

PATENTED FLOW DESIGN

4 BBL UNIQUE HIGH FLOW DESIGN
CNC-machined aluminum ring (laminated into the air box) fits perfectly on carburetor to maximize airflow



DETAILS AND



DIMENSIONS

» FOR INDIVIDUAL PART DIMENSIONS, VISIT FIVESTARBODIES.COM

REFLECTIVE HEAT SHIELD KITS

- » Thin reflective adhesive film reflects over 90% of radiant heat from the engine, up to 500°F
- » Easy to cut and install to protect any part of the race car from high heat:
 - » All Cold Air Boxes
 - » Interiors
 - » Foot Boxes
 - » Shock Canisters
 - » Fuel Filter Housings
 - » And more

Cold Air Box Kit, 4 oz	000-52HS	\$74
5'x26" Length Sheet, 3oz per ft	000-5HS	\$74



FULLY INSTALLED COLD AIR BOX KIT 000-52HS

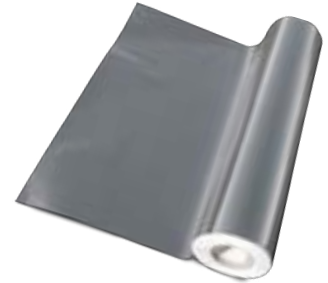

5' LENGTH SHEETS 000-5HS



ROUNDED BOTTOM | 000-5200A



SQUARE BOTTOM | 000-5100A-B



COWL AIR DEFLECTORS

- » Smoothly flows air from cowl air opening into cold air box
- » Black Ultraglass Composite
- » Rounded Bottom: 20" x 7", Square Bottom: 20-1/8" x 7-1/2"
- » Fits all air box styles listed on page 132
- » 000-5100A-B available & fits older style 51-series air boxes

Rounded Bottom	000-5200A	\$55
Square Bottom	000-5100A-B	\$70

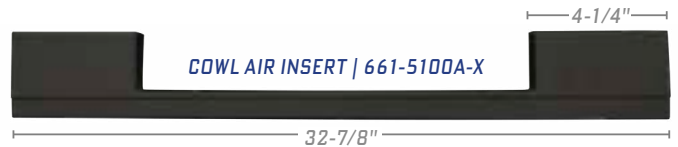

COWL AIR INSERT | 661-5100A-X

COWL AIR INSERT

- » Designed for maximum airflow directly into the cold air box
- » Made of Ultraglass composite & oversized for left & right adjustment to properly fit the airbox
- » Opening meets all sanctioning regulations
- » Included with ABC Body Packages
- » Available in 4 colors

Cowl Air Insert	661-5100A-X	\$68	\$73
-----------------	-------------	------	------

FITS THESE BODY STYLES: ABC NEXTGEN, ABC, NORTH AMERICAN SPORTSMAN, S2, STRAIGHT-UP METAL, SHORT TRACK TRUCK



ALUMINUM COWL BRACKET TABS

- » Create a positive seal by holding hood flat at the cowl
- » Mounts along front flange of Cowl Panel
- » Fits 3/8" or 1/2" Hood Pins
- » Kit is included with cowl panels
- » Kit includes: 4 laser-cut aluminum tabs weighing 0.5 oz each

Cowl Bracket Tabs	000-510	\$13
-------------------	---------	------



REAR BUMPERS

- » Formed using CNC progressive tube bending technology
- » Fits the exact contour of Five Star noses for maximum protection and ease of installation
- » Formed from 1-3/4" OD round steel tubing
- » For a complete secure mount, it is recommended to install your bumpers with Five Star's Rear Bumper Mounting Kits

ABC NextGen, .065" steel	11002-71682	\$48	Street Stock '88 Monte Carlo, .065" steel	600-7501	\$48
NextGen LMSC, .065" steel	11002-71682	\$48	Dirt Grand National, .065" steel	570-7503	\$48
ABC / LMSC / Straight-Up Metal, .065" steel	570-7503	\$48	Short Track Truck, .065" steel	T000-7503	\$48
North American Sportsman, .065" steel	11002-71682	\$48			

REAR BUMPER FULLY INSTALLED WITH HEIGHT ADJUSTABLE MOUNTING KIT
(HIGHLIGHTED IN ORANGE)

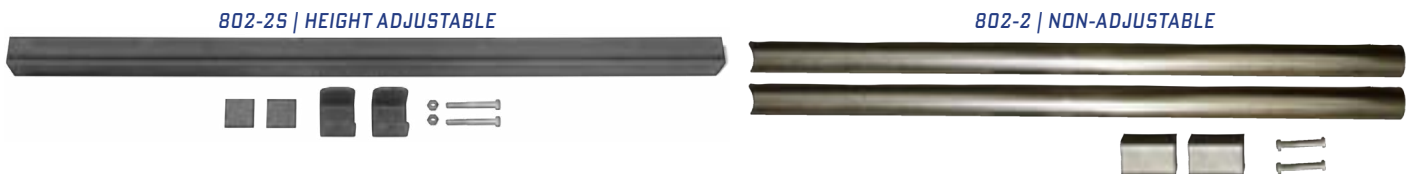
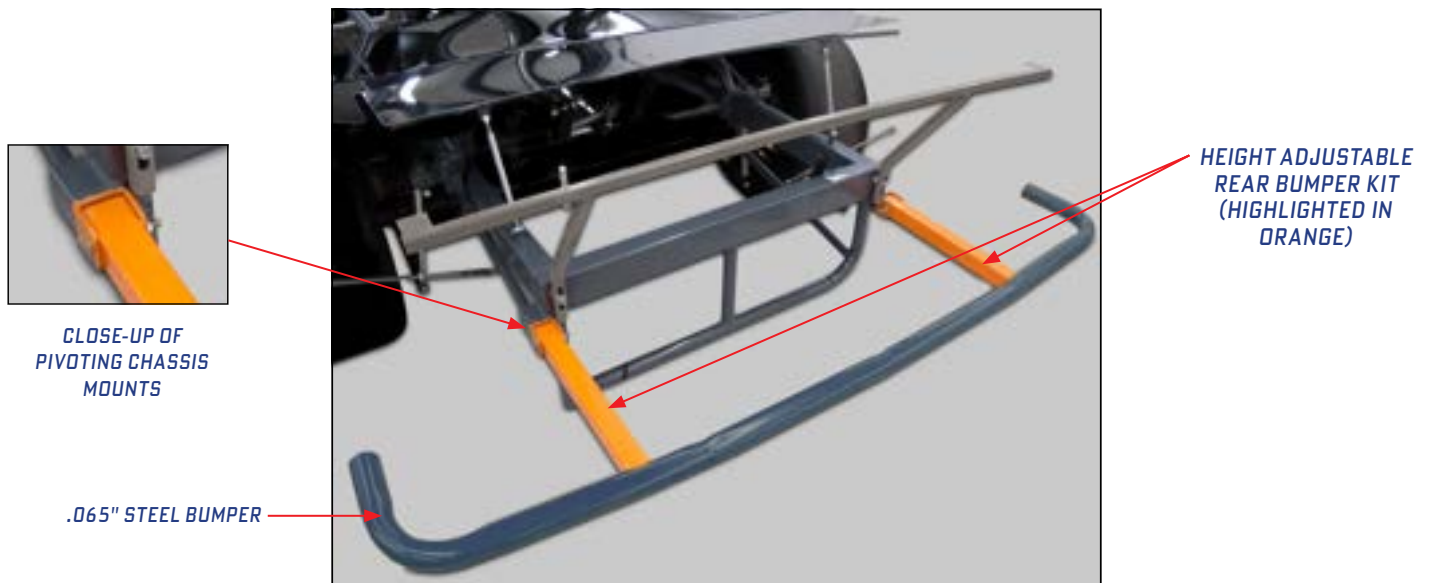

REAR BUMPER MOUNTING KITS

- » Everything you need to mount the bumper to the chassis
- » Universal design for all Five Star Short Track Noses
- » Fits all chassis configuration
- » Available in two options:
 - » **Height-Adjustable Kit:** (PN 802-2S) Allows for several different mounting options and pivots to allow precise adjustments to the height of the rear bumper cover
Kit includes: 2 pivoting chassis mounts; 1 36" long 1-1/2" square piece of tubing; 2 pieces of flat stock; 2 1/2" nuts and bolts
 - » **Non-Adjustable Kit:** (PN 802-2) Make your bumper a bolt-on component
Kit includes: 2 3' long x 1-3/4" thick pieces of round tubing, 2 pieces of .120" thick square tubing and 5/16" hex bolts & nuts

Height-adjustable Kit	802-2S	\$49
Non-adjustable Kit	802-2	\$38

STEEL REAR DECK MOUNTING KIT

- » Everything you need to properly fabricate a perfect fitting brace from the rear bumper cover & deck lid to the chassis
- » **Deck Lid Bracket:** (PN 660-450-DLB) supports your rear body clip by securing it to the rear bumper cover & quarter panel.
Kit includes: 2 tabs for hood pins; weighs 36 oz
- » **Deck Lid Height Slider Kit:** (PN 802-3) allows for easy adjustment of spoiler height with 3-1/2" of deck lid height adjustability.
Kit includes: 2 pieces slotted 3/4" square tubing, 3/8" hex bolts & nuts
- » **Deck Lid Hold-down Kit:** (NOT SOLD SEPARATELY) allows for a removable deck lid.
Kit includes: 1 aluminum deck lid hold-down strip, 2 mounting tabs, 4 jam nuts, 2 3/8" gun-drilled, anodized aluminum pins & scuff plates (SILVER), & 2 flip-over steel clips

Rear Deck Mounting Kit	660-450-RDK	\$87
Replacement Deck Lid Bracket	660-450-DLB	\$32
Replacement Deck Lid Height Slider Kit	802-3	\$16

FITS THESE BODY STYLES: ABC NEXTGEN, ABC, NEXTGEN LMSC, LMSC, NORTH AMERICAN SPORTSMAN, S2, STRAIGHT-UP METAL, STREET STOCK, DIRT GRAND NATIONAL, MINI STOCK

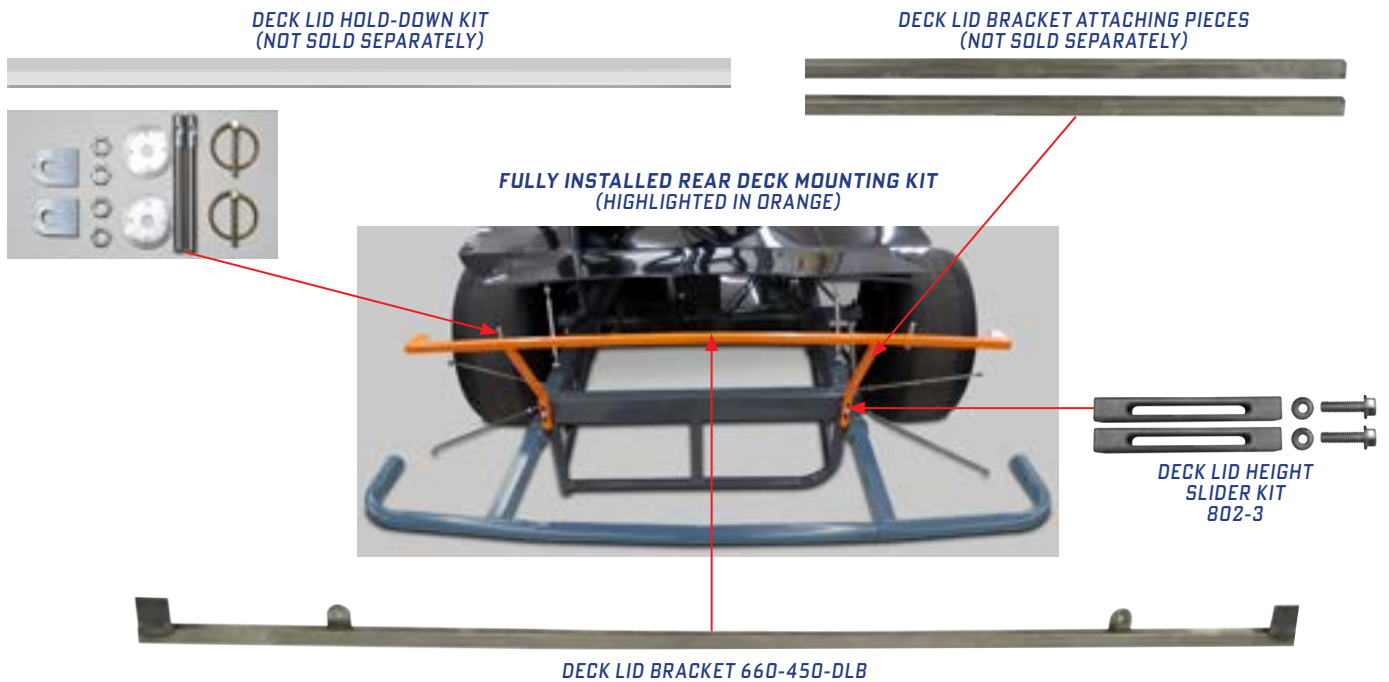

ONLY WEIGHS 17 OZ
LESS THAN HALF THE WEIGHT OF STEEL

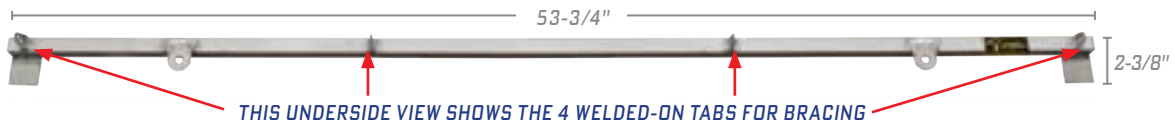

ALUMINUM DECK LID BRACKET

- » This is a premium upgrade from the steel deck lid bracket to save weight without sacrificing strength
- » Mounts to the rear bumper cover and quarter panel, includes 2 tabs for hood pins and 4 tabs for chassis mounting options
- » Complete the combination with our 3/8" Hood Pin Kit (PN 10001-34033-X)

Aluminum Deck Lid Bracket	11002-75633	\$49
---------------------------	-------------	------

FITS THESE BODY STYLES: ABC NEXTGEN, ABC, NEXTGEN LMSC, LMSC, NORTH AMERICAN SPORTSMAN, S2, STRAIGHT-UP METAL, STREET STOCK, DIRT GRAND NATIONAL, MINI STOCK



UNPAINTED BRACKETS WITH BLADES



BLACK POWDER-COATED BRACKETS WITH BLADES, FULLY INSTALLED USING 807-3 ADJUSTABLE BODY BRACES (SOLD SEPARATELY, SEE PG 141)

REPLACEMENT SPOILER BRACKETS & BLADES

- » 2-piece polycarbonate blade with 2-piece aluminum bracket, your choice of unpainted or black powder-coated
- » Available in 90, 70 and 55 degree angles

ABC NextGen / NA Sportsman	5" (90°)	5" (70°)	6-1/2" (90°)	6-1/2" (70°)			
Brackets, replacement, aluminum, 60"	11002-47369-1	11002-47367-1	11002-47369-1	11002-47367-1	\$80		
Brackets, replacement, aluminum, 64-1/2"	N/A	N/A	11002-47389-1	11002-47377-1	\$80		
Brackets, replacement, aluminum, black, 60"	11002-47369-1B	11002-47367-1B	11002-47369-1B	11002-47367-1B	\$90		
Brackets, replacement, aluminum, black, 64-1/2"	N/A	N/A	11002-47389-1B	11002-47377-1B	\$90		
Blades, replacement, polycarbonate, 60"	11002-47359-2	11002-47357-2	11002-47369-2	11002-47367-2	\$49		
Blades, replacement, polycarbonate, 64-1/2"	N/A	N/A	11002-47389-2	11002-47387-2	\$59		
ABC / S2 / SU-Metal	5" (90°)	5" (70°)	5" (55°)	6-1/2" (90°)	6-1/2" (70°)	6-1/2" (55°)	
Brackets, aluminum	661-6739-1	661-6737-1	661-6735-1	661-6739-1	661-6737-1	661-6735-1	\$80
Brackets, aluminum, black	661-6739-1B	661-6737-1B	661-6735-1B	661-6739-1B	661-6737-1B	661-6735-1B	\$90
Blades, polycarbonate	661-6749-2	661-6747-2	661-6745-2	661-6739-2	661-6737-2	661-6735-2	\$49



SPOILER IS FULLY INSTALLED ON THE BUMPER COVER USING THE SPOILER MOUNTING KIT

ALUMINUM SPOILER MOUNTING KIT

- » Everything needed to mount the polycarbonate spoiler blade to the bracket, & the bracket to the bumper cover
- » 76-piece kit includes: 32 lightweight machined aluminum inner & outer washers, 22 flat head socket screws & 22 locknuts

Spoiler Mounting Kit	000-67K	\$33
----------------------	---------	------

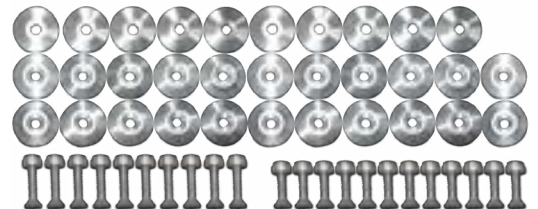



FULLY MOUNTED POLYCARBONATE RUB RAIL



POLYCARBONATE RUB RAIL

- » Protect your vinyl without hiding it!
- » Attach to side of body to eliminate tire marks on fenders, doors, and quarter panels
- » Ultra-durable polycarbonate to absorb impact
- » Can be trimmed to fit your application

Rub Rail, 75" long	000-2100	\$21 ea
--------------------	----------	---------



PLASTIC VERSION INCLUDES CURVED EDGE FOR OPTIMUM AERODYNAMICS



000-5501P-W
MOLDED PLASTIC STANDARD ROCKER PANEL

ALUMINUM VERSION HAS ENDS ROLLED BY SPECIAL PROCESS, ENHANCING AIR FLOW



000-5501A-W
ALUMINUM STANDARD ROCKER PANEL



000-5500A-W
ALUMINUM STRAIGHT ROCKER PANEL

EDGES ARE LEFT STRAIGHT, NOT CURVED

MOLDED PLASTIC & ALUMINUM ROCKER PANELS

- » Mounts below the fender / door / quarter panel area and fits either side
- » Curved edges provide optimum aerodynamics and adds structural integrity to side body panels
- » Manufactured in high-impact plastic and lightweight aluminum
- » Available in 5 color options

			W-B	CB-R-Y
High-Impact Plastic (N/A IN YELLOW)	000-5501P-x	82" x 5"	\$33	\$38
Aluminum	000-5501A-x	77-3/4" x 5"	\$39	\$39
Aluminum, straight	000-5500A-x	79" x 4-3/4"	\$39	n/a

FITS THESE BODY STYLES: ABC NEXTGEN, ABC, NEXTGEN LMSC, LMSC, NORTH AMERICAN SPORTSMAN, S2 SPORTSMAN, SHORT TRACK TRUCK, STREET STOCK



FULLY INSTALLED WINDOW BRACE KIT

WEIGHS LESS THAN 2 LBS



ALUMINUM WINDOW BRACES

- » Strongest window braces on the market
- » Designed to the exact contour of your Five Star windows
- » Made of premium high-strength aluminum with flat black powder-coated finish
- » Foam-padded surface won't scratch your windows
- » Pre-drilled holes to mount adjustable bracing from the interior dash
- » **Kit includes:** 3 aluminum braces & installation hardware

Windshield Brace Kits		C=Center, L=Left, R=Right, O=outer, all 1" Wide	
ABC Next Gen Windshield Brace Kit	11002-76333	24-1/8"(C), 24-1/4"(L), 24-1/2"(R)	\$76
NextGen Late Model Stock Car Windshield Brace Kit	13002-76333	25-5/8"(C), 25-1/2"(L), 25-5/8"(R)	\$76
ABC/LMSC/Straight-Up Metal Windshield Brace Kit	564-6301	28-5/8" x 1"	\$76
North American Sportsman Windshield Brace Kit	12001-76333	26" x 1"	\$76
Pavement Modified Windshield Brace Kit	020-6301	26-1/2" x 1"	\$76
Short Track Truck Windshield Brace Kit	21001-76333	31-5/8"(C), 31-3/4"(L), 31-1/2"(R)	\$76
Rear Window Brace Kits		C=Center, L=Left, R=Right, O=outer, all 1" Wide	
ABC NextGen Rear Window Brace Kit	11002-76133	30-7/8"(C), 30-5/8"(O)	\$76
NextGen Late Model Stock Car Rear Window Brace Kit	11002-76133	30-7/8"(C), 30-5/8" (O)	\$76
ABC/LMSC/Straight-Up Metal Rear Window Brace Kit	674-6101	32" x 1"	\$76
North American Sportsman Rear Window Brace Kit	12001-76133	31-1/4"(C), 30-1/2"(O)	\$76
Pavement Modified Rear Window Brace Kit	020-6101	34" x 1"	\$76



IMPORTANT:
 USING RIVETS APPLIES TOO MUCH PRESSURE TO YOUR WINDOW & WILL FRACTURE THE POLYCARBONATE



WINDOW INSTALLATION KIT

- » Using proper hardware provides the perfect fit & helps to increase the life of your window
- » Black oxide coated to prevent rust
- » Enough hardware to install a complete set of windows on one car
- » **Kit includes:** 120 6-32 1/2" & 16 6-32 3/4" flat head socket screws, 136 6-32 nylon locknuts, 1 long-arm hex key & 9/64" drill bit

Window Installation Kit	805	\$23
-------------------------	-----	------

WINDOW INSTALLATION COUNTERSINK DRILL BIT

- » 3/8" diameter steel bit, 1/4" shank, used for countersinking holes for window screw installation into polycarbonate
- » Not required for pre-cut to fit, beveled, & drilled windows

Drill Bit	805-1	\$19
-----------	-------	------

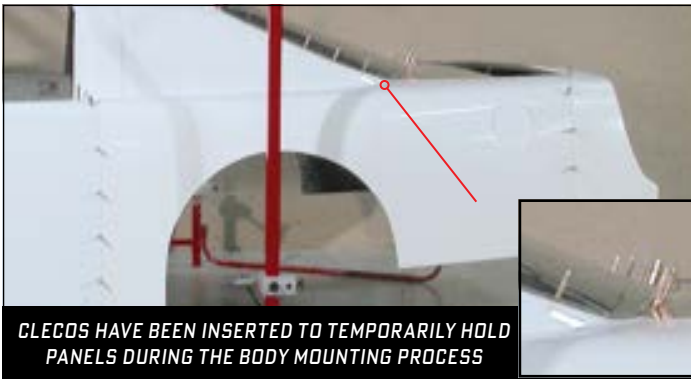

CLECOS HAVE BEEN INSERTED TO TEMPORARILY HOLD PANELS DURING THE BODY MOUNTING PROCESS



1/8"



3/16"

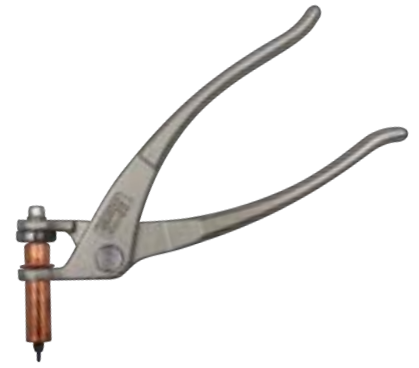

CLECO KIT & PLIERS

- » Precision has never been this easy! Cleco Pliers & Cleco Fasteners ensure perfect alignment every time
- » Clecos can be easily inserted with the Cleco Pliers to temporarily hold panels during the body mounting process
- » Our Cleco pliers are engineered for comfort & built to last, ensuring a secure grip & maximum control
- » Choice of 1/8" 25-piece Cleco Kit or 3/16" 25-piece Cleco Kit

1/8" Single Spade Kit, long	812	\$24
3/16" Single Spade Kit, long	813	\$32
Cleco Pliers	811	\$12

RIGHT SIDE DOOR SUPPORT

- » Easily adjust your right side door to the proper width
- » This piece connects your right side door bar to your door
- » .080" thick aluminum laser-cut to reduce weight
- » Laser cutting allows for precise, consistent shape & weight
- » Slotted mounting holes allow for easy inner & outer door adjustments to proper width
- » Weighs under 2 lbs

Aluminum Door Support	11002-75533	\$30
-----------------------	-------------	------



[DETAILS AND](#)



[DIMENSIONS](#)

DRILL BIT KIT

- » Special double-ended drill bits
- » These bits drill a slightly larger diameter hole than a standard 1/8" or 3/16" bit to prevent stress cracks in the material
- » The short drill shaft makes drilling in tight places easier
- » Kit includes: 2 9/64" double-ended drill bits & 2 #30 double-ended drill bits

Drill Bit Kit	806	\$18
---------------	-----	------



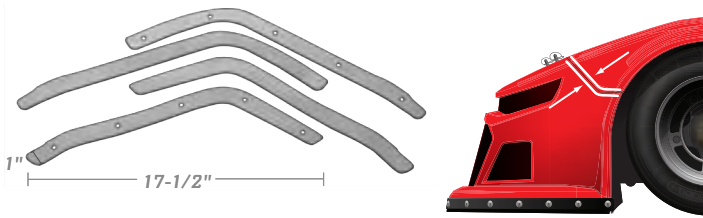

11002-75133

FOR ABC NEXTGEN, 2020 LATE MODEL STOCK CAR, NORTH AMERICAN SPORTSMAN



000-24B

FOR ABC, LMSC, S2, STRAIGHT-UP METAL, DIRT GRAND NATIONAL

FENDER-TO-NOSE BACK-UP PLATES KIT

- » Reinforces the flange where the fenders mount to the nose
- » Pre-drilled holes in the necessary locations for quick & easy mounting
- » Made of .063" thick aluminum
- » **4-piece kits include: 2 front & 2 rear plates** (ENOUGH FOR BOTH SIDES)

ABC NextGen / NextGen LMSC / NA Sportsman	11002-75133	\$20
Other Body Styles*	000-24B	\$21

*FITS THESE BODY STYLES: ABC, LMSC, S2, STRAIGHT-UP METAL, DIRT GRAND NATIONAL

GREENHOUSE-TO-QUARTER PANEL BACK-UP PLATES KIT

- » Reinforce the flanges where the rear greenhouse meets the quarter panels
- » Universal fit for all greenhouse-style quarter panels
- » Each back-up plate is 60 X 1-12"
- » Recommended for molded plastic quarter panels
- » **Kit includes: 2 pre-cut aluminum strips**

2-piece Kit	000-27B	\$7
-------------	---------	-----

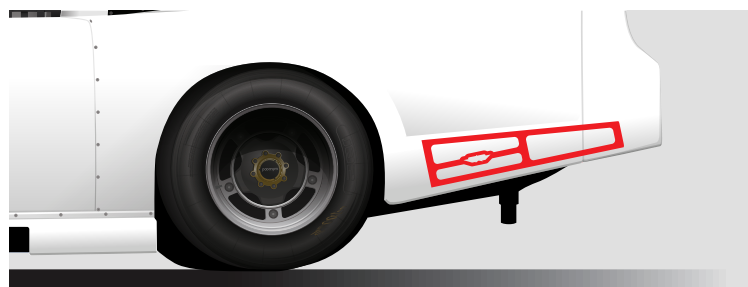
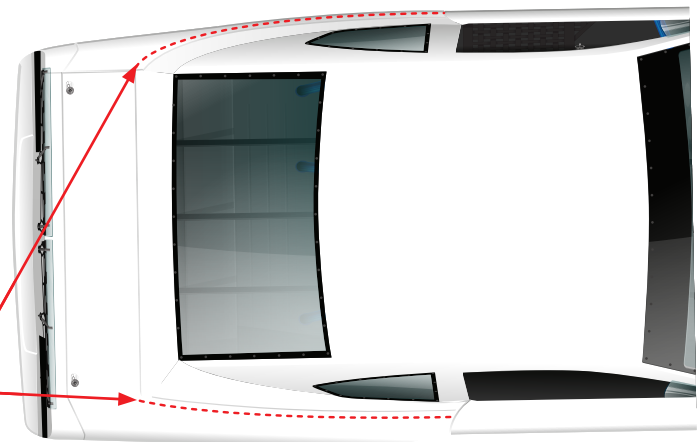

WEIGHS ONLY 1 LB

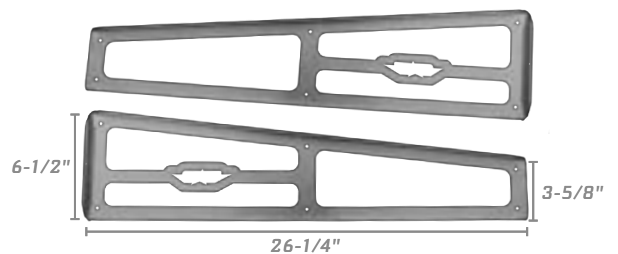

QUARTER PANEL BODY BRACE KIT

- » Stiffens the quarter panel to maintain correct shape in an aero sensitive area
- » Highly recommend bracing for tracks 1/2-mile & longer
- » Laser-cut aluminum braces have pre-drilled holes for brace attachment
- » **Kit includes: 2 braces that mount approximately 6" back from the wheel opening & 2" up from the bottom ledge**

Brace Kit, 2-piece	11002-75433	\$39
--------------------	-------------	------



EASY INSTALLATION WITH ENDS SHAPED FOR INCLUDED SCREW KIT OR 2 RIVETS



ADJUSTABLE BODY BRACES

- » Used for spoiler & roof supports & anywhere on your car to fit templates & meet other critical dimensions
- » Easy installation with ends shaped for included screw kit or 2 rivets
- » Adjustable from 8" to 10-1/2" & features durable anodized black finish & zinc-plated hardware
- » Add extra support without adding excess weight! Package of 2 weighs only 1/2 lb
- » Can also be attached to Five Star's Chassis Clamps for quick & easy adjustable bracing on your chassis

Body Braces, 2 pack	807-3	\$35
---------------------	-------	------

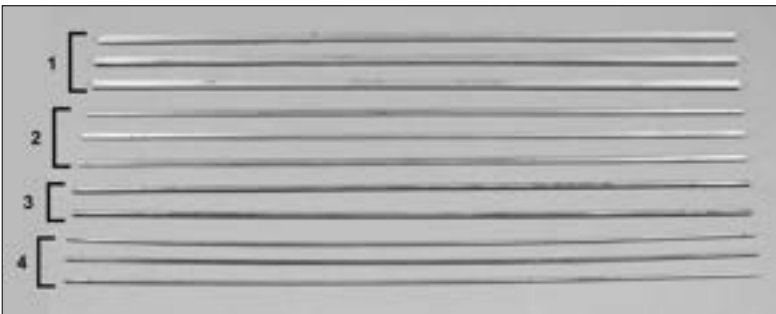

Number	Shape	Dia	Thickness	Length
1	(3) round	3/8"	.062"	60"
2	(3) square	1/2"	.035"	60"
3	(2) round	1/2"	.062"	60"
4	(3) square	3/4"	.049"	60"

STEEL TUBING INSTALLATION KIT

- » 55 feet of .035" hard-to-find, lightweight steel tubing for any miscellaneous needs on a race car
- » Will save at least 12 lbs over standard .065" steel tubing
- » Kit includes various shapes and sizes in 60" lengths

11-pcs: 60" lengths	819	\$79
---------------------	-----	------



FORMED POLYCARBONATE BODY BRACES

- » Universal brace to fit any applicable area of your car
- » Each lightweight brace weighs only 7 oz
- » Absorbs impact & allows body panels to flex upon impact & return to original position & shape
- » Kit includes: 7 clear polycarbonate braces & 14 1"x2" aluminum mounting tabs

Polycarbonate Braces	804	\$30
----------------------	-----	------

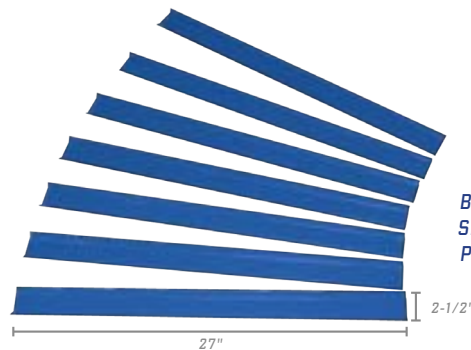

BRACES ARE SHOWN WITH PROTECTIVE MASKING



FULLY INSTALLED CUSTOM BRACE KIT



TAP | 807L OR 807R



THREADED END ASSEMBLIES | 807-2



ALUMINUM TUBING | 807-1

ALUMINUM CUSTOM BRACING KIT

- » Build your own custom-length bracing as short as 6" or as long as 40"
- » Order as many tubing kits or end assemblies as needed to custom brace your car
- » Threaded end assemblies can be bolted, riveted, or attached with hose clamps
- » **Complete kit includes:** 1 aluminum tubing kit; 1 threaded end assembly kit; 1 left & 1 right 1/4-20 reusable tap
- » **Aluminum Tubing kit includes:** 2 7/16" x 3' hollow hex rods. Cut to desired length & can be tapped easily
- » **Threaded End Assemblies kit includes:** 2 right and 2 left threaded ends, 2 hose clamps that weighs 7.5 oz

Complete Kit	807	\$68
REPLACEMENT PARTS		
Tubing Kit, 2-piece	807-1	\$29
End Assemblies, 6-piece	807-2	\$19
Tap, left or right	807LorR	\$10



CLOSE UP OF FULLY INSTALLED TAB



STEEL BODY MOUNTING TABS

- » Designed to be welded onto chassis as a universal mount for many applications
- » Makes mounting easier by positioning bracing and mounts right where you need them
- » 25-piece kit includes enough lightweight weld-on tabs to install a complete body & weighs 5 oz
- » Each tab is 1-1/8" x 1-2"
- » Use for roof, cowl, deck lid, side bracing, and more

25 Piece Kit	807-4	\$24
--------------	-------	------



TWO BRACES CAN BE MOUNTED & BRANCHED OFF A SINGLE MOUNTING END

THUMB SCREW FOR QUICK, EASY ADJUSTMENT TO MEET CRITICAL DIMENSIONS

TWO BRACES CAN ALSO BE MOUNTED TO A FIVE STAR CHASSIS CLAMP

STAMPED ALUMINUM MOUNTING END CLOSE-UP

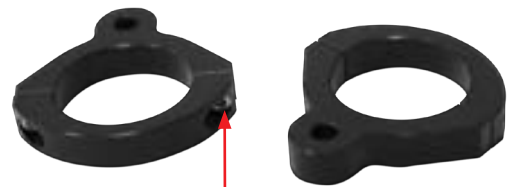

INCLUDES TWO SCREWS FOR QUICK, EASY INSTALLATION & ADJUSTMENT WITH 3MM ALLEN WRENCH

» NYLON (MOST FLEXIBLE) WEIGHS 5 OZ EA

» ALUMINUM (LIGHTEST) WEIGHS 3.25 OZ EA

» STEEL (MOST DURABLE) WEIGHS 8.25 OZ EA

PREMIUM ADJUSTABLE BODY BRACE KITS

- » Available in three options: aluminum, nylon, or steel
- » Adjustable to a maximum length of 30-1/2"
- » Stamped, black anodized aluminum mounting ends
- » Thumb screw for quick, easy length adjustments without tools
- » Kits come complete in a pack of 2

Flexible Nylon Brace Kit	10001-75951	\$33
Aluminum Brace Kit	10001-75933	\$30
Steel Brace Kit	10001-75931	\$21

ALUMINUM CHASSIS CLAMPS

- » Universal mount fits anywhere bracing is needed
- » Eliminate the need for welding or use of hose clamps when mounting body braces
- » Threaded flange / no nut required
- » Three options to fit different roll bar tubing thickness
- » Lightweight black anodized aluminum, each clamp weighs just 1.3 oz
- » Ideal for use with Five Star's Premium Adjustable Body Braces
- » Kits include: 2 clamps with 1/4-20 screws

1-1/2", aluminum, 2 pack	10001-74133	\$21
1-3/4", aluminum, 2 pack	10001-74333	\$21
1-5/8", aluminum, 2 pack	10001-74533	\$21

DETAILS AND



DIMENSIONS

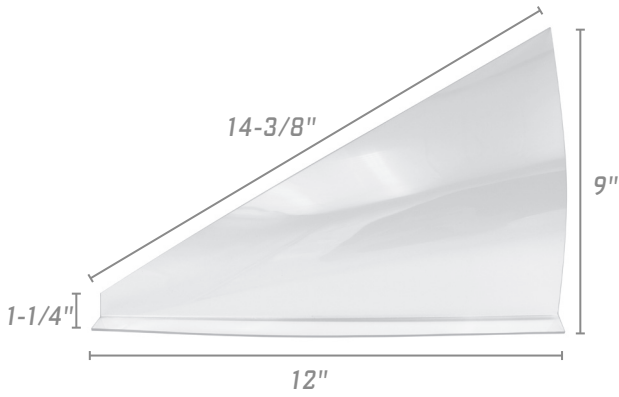

THE 11002-66222 DOOR VENT WINDOW IS CUT-TO-FIT FOR FAST & EASY INSTALLATION

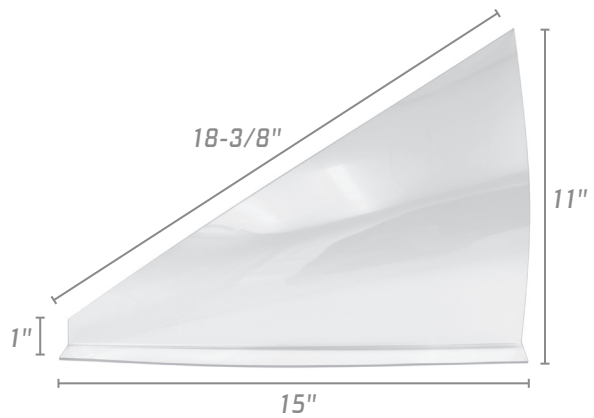

THE 000-6202 DOOR VENT WINDOW IS OVERSIZED; TRIM TO FIT YOUR APPLICATION



POLYCARBONATE DOOR VENT WINDOWS

- » Molded vent windows give cars a proven performance gain in the wind tunnel over flat unmolded windows
- » Oversized and cut-to-fit options made of molded, mar-resistant coated clear .093" polycarbonate

Precut-to-fit, set of 2	11002-66222	\$33
<i>FITS THESE BODY STYLES: ABC NEXTGEN, NEXTGEN LMSC</i>		
Universal, set of 2	000-6202	\$35

WIDE ANGLE RACING MIRROR

- » This convex glass mirror gives you the best view of your competition, includes a bracket kit for easy installation
- » All black frame with black anodized machined aluminum brackets
- » Only weighs 19 oz

Convex Glass Mirror	00001-85020	\$39
---------------------	-------------	------



UNIVERSAL MIRROR MOUNTING BRACKET

- » This stamped lightweight aluminum bracket allows for easy installation on any chassis
- » Satin black powder coated finish

Replacement Bracket	820-B	\$9
---------------------	-------	-----



THE PERFECT SURFACE PREP FOR PLASTIC

MD3 ADHESION PROMOTER

NEW!



FAST DRYING & NON-SANDING

MD3 ADHESION PROMOTER

- » Specifically engineered adhesion promoter assures proper paint bonding to our special plastic
- » Other automotive grade primers on the market may not work at all or cause severe paint flaking
- » Improves adhesion of vinyl by enhancing the bond between adhesive on the vinyl and the substrate, for a more durable, long-lasting application
- » Comes in an aerosol spray can for quick and easy application
- » A single can coats approximately 5 individual parts

MD3 Adhesion Promoter	842	\$16
-----------------------	-----	------

» A MUST USE PRODUCT BEFORE PAINTING OR APPLYING VINYL ON ANY FIVE STAR PLASTIC PART

FIVE STAR PLASTIC WINDOW CLEANER

- » This specially formulated anti-static foaming spray contains no chemicals or abrasives that will cause damage to plastic
- » Lifts grease, grime, and wipes off fast and easy to provide a streak-free clean and clear surface finish

Window Cleaner, 19oz Can	843	\$9.95
--------------------------	-----	--------

» FIVE STAR CLEANING TIPS!

- » ALWAYS AVOID USING ABRASIVE CLEANERS & CHEMICAL SOLVENTS THAT CAN EASILY CAUSE DAMAGE TO POLYCARBONATE WINDOWS
- » USE A MICROFIBER TOWEL FOR BEST, STREAK-FREE FINISH
- » TO PREVENT SCRATCHING AND HAZING ON YOUR WINDOWS, NEVER SCRUB WITH BRUSHES OR ABRASIVE MATERIALS



PRICING SUBJECT TO CHANGE WITHOUT NOTICE

UNIVERSAL SHORT TRACK

NOSES, BUMPER COVERS & COMPONENTS

VINYL NOSE GRAPHIC ID KITS FOR A REALISTIC OEM LOOK!

PRINTED ON OUTDOOR DURABLE HIGH-TACK VINYL • GLOSSY LAMINATED SURFACE PROVIDES EXCELLENT PROTECTION



'97 CHEVROLET CAMARO

-W

Nose	150-410-W	\$178
------	-----------	-------

*NOSE GRAPHIC ID KITS NO LONGER AVAILABLE

'97 CHEVROLET CAMARO

-W

Bumper Cover	150-450-W	\$160
--------------	-----------	-------

*BUMPER COVER GRAPHIC ID KITS NO LONGER AVAILABLE



'92 CHEVROLET CAMARO

-B -W

Nose (PAVEMENT)	140-410-x	\$178
-----------------	-----------	-------

Nose ID Kit	140-410-ID	\$37
-------------	------------	------

'92 CHEVROLET CAMARO

-B -W

Nose	145-410-x	\$178
------	-----------	-------

Nose ID Kit	140-410-ID	\$37
-------------	------------	------



'81 CHEVROLET CAMARO

-B

Nose, Upper	210-410U-B	\$80
-------------	------------	------

*NOSE GRAPHIC ID KITS NO LONGER AVAILABLE

'81 CHEVROLET CAMARO

-B

Nose, Lower	210-410L-B	\$75
-------------	------------	------

*NOSE GRAPHIC ID KITS NO LONGER AVAILABLE



'03 CHEVROLET MONTE CARLO -B -W

Nose (FG SPORTSMAN)	639-410-x	\$178
Nose (SHORT TRACK)	640-410-x	\$178
Nose ID Kit	630-410-ID	\$37

'03 CHEVROLET MONTE CARLO -B -W

Bumper Cover	630-450-x	\$160
Bumper Cover ID Kit	630-450-ID	\$36



'99 CHEVROLET MONTE CARLO -B -W

Nose	620-410-x	\$178
Nose ID Kit	620-410-ID	\$37

'99 CHEVROLET MONTE CARLO -B -W

Bumper Cover	620-450-x	\$160
Bumper Cover ID Kit	620-450-ID	\$36



'94 CHEVROLET LUMINA -W

Nose	610-410-W	\$178
------	-----------	-------

'94 CHEVROLET LUMINA -W

Bumper Cover	610-450-W	\$160
--------------	-----------	-------

*NOSE GRAPHIC ID KITS NO LONGER AVAILABLE

*BUMPER COVER GRAPHIC ID KITS NO LONGER AVAILABLE



'03 FORD TAURUS

-B -W

Nose	550-410-x	\$178
Nose ID Kit	550-410-ID	\$37



'03 FORD TAURUS

-B -W

Bumper Cover	550-450-x	\$160
--------------	-----------	-------

**BUMPER COVER GRAPHIC ID KITS NO LONGER AVAILABLE*



'97 FORD THUNDERBIRD

-W

Nose	530-410-W	\$178
------	-----------	-------

**NOSE GRAPHIC ID KITS NO LONGER AVAILABLE*



'97 FORD THUNDERBIRD

-W

Bumper Cover	530-450-W	\$160
--------------	-----------	-------

**BUMPER COVER GRAPHIC ID KITS NO LONGER AVAILABLE*



PONTIAC GRAND PRIX

-B -W

Nose	360-410-x	\$164
Nose ID Kit	360-410-ID	\$37

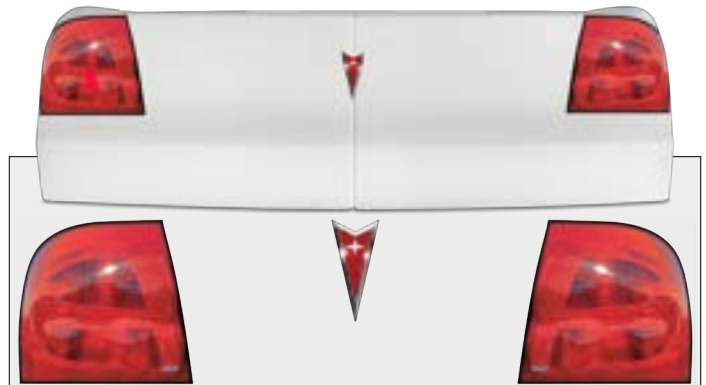

PONTIAC GRAND PRIX

-B -W

-CB -R

Bumper Cover	460-450-x	\$155	\$160
Bumper Cover ID Kit	360-450-ID	\$36	\$36



'97 OLDSMOBILE CUTLASS

-W

Nose	710-410-x	\$178
Nose ID Kit	710-410-ID	\$37



H00-410S: Round, small \$8



H01-410S: Rectangle, small \$8



H00-411S: Round, large \$8



H01-411S: Rectangle, large \$8

NEW!

ACHIEVE MAXIMUM VINYL ADHESION BY USING MD3 ADHESION PROMOTER. DETAILS AND ORDERING INFORMATION ON PAGE 147!



» ALUMINUM NOSE SCREENS: PROTECT YOUR RADIATOR FROM DEBRIS PENETRATION



UNPAINTED

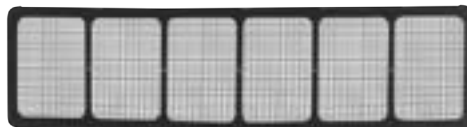

BLACK POWDER-COATED

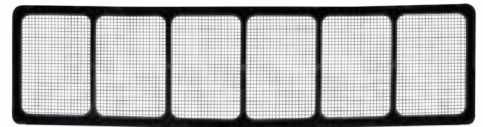

BLACK ALUMINUM FRAME

ALUMINUM NOSE SCREENS

- » Protects the radiator from debris penetration
- » Frame is laser cut from lightweight aluminum
- » Screen is high strength stainless steel (3/16" mesh is crimped, 1/4" is welded)
- » Available options: black aluminum frame, unpainted, or with durable satin black powder-coated finish

PN	NOSE SCREEN DESCRIPTION	WIDTH (Top)	WIDTH (Bottom)	HEIGHT	MESH	
630-4111	O1 Monte Carlo, Lower	34"	34"	6"	3/16"	\$50
660-4111	Common*, Lower	27-3/4"	27-3/4"	7-1/4"	3/16"	\$50
660-4111-B	Common, Lower, Black	27-3/4"	27-3/4"	7-1/4"	3/16"	\$55
660-4112	Common, Lower	27-3/4"	27-3/4"	7-1/4"	1/4"	\$50
660-4112-B	Common, Lower, Black	27-3/4"	27-3/4"	7-1/4"	1/4"	\$55
10001-46333B	Common, Lower, Black aluminum frame	27-3/4"	27-3/4"	7-1/4"	3/16"	\$55
10001-46433B	Common, Lower, Black aluminum frame	27-3/4"	27-3/4"	7-1/4"	1/4"	\$55

*COMMON NOSE SCREEN FITS THESE BODY STYLES: ABC NEXTGEN, ABC, NEXTGEN LATE MODEL STOCK CAR, LATE MODEL STOCK CAR, NORTH AMERICAN SPORTSMAN, STRAIGHT-UP METAL, MD3 CAMARO/MUSTANG STREET STOCK, DIRT GRAND NATIONAL

PRICING SUBJECT TO CHANGE WITHOUT NOTICE

ABC LMSC TRUCK RAY/MODIFIED OUTLAW LATE MODEL SPORTSMAN STREET STOCK MD3 LATE MODEL MD3 MODIFIED DIRT GRAND NAT'L TAZ PRO STOCK/MOD FUNNY CAR WINDOWS ACCESSORIES

BODY PACKAGES & COMPONENTS

ABC Greenhouse.....24
 ABC NextGen.....16
 ABC Traditional Roof.....32
 Camaro Pro Stock/Pro Mod.....106
 Camaro Top Alcohol Funny Car.....114
 Dirt Grand National.....92
 Dirt Late Model.....76
 Dirt Modified.....86
 Mustang Pro Stock/Pro Mod.....106
 NextGen Late Model Stock Car.....40
 North American Sportsman.....62
 Older Body Styles.....69
 Outlaw Late Model.....58
 Pavement Modified.....54
 Short Track Truck.....48
 Street Stock.....70
 TA2 Road Racing.....96

A

Air Filter Deflector
 Dirt Late Model.....83
 Dirt Modified.....90
Air Inlet Extension.....131
Adhesion Promoter.....145

B

Back-Up Plate Kits
 Greenhouse/Quarter.....142
 Nose/Fender.....142
Bed Covers
 Short Track Truck.....50
Bed Sides
 Short Track Truck.....50
Body Mounting Tabs.....144
Braces, Body
 Adjustable.....19, 27, 35, 51, 65, 143
 Plastic.....84, 91
 Polycarbonate.....143
 Premium Adjustable.....145
 Custom.....144
 Nose Side.....19, 27, 35, 51, 65, 130
 Quarter Panel.....142

Braces, Windshield

ABC NextGen.....19, 140
 ABC Greenhouse.....27, 140
 ABC Traditional Roof.....35, 140
 NextGen Late Model Stock Car.....43, 140
 North American Sportsman.....65, 140
 Short Track Truck.....51, 140
 Pavement Modified.....140
 TA2 Road Racing.....104

Braces, Window, Rear

ABC NextGen.....19, 140
 ABC Greenhouse.....27, 140
 ABC Traditional Roof.....35, 140
 NextGen Late Model Stock Car.....43, 140
 North American Sportsman.....65, 140
 Short Track Truck.....140
 Pavement Modified.....140
 TA2 Road Racing.....104

Brake Ducts, Single.....132

Bumpers, Front

ABC NextGen.....18, 128
 ABC Greenhouse.....26, 128
 ABC Traditional Roof.....35, 128
 NextGen Late Model Stock Car.....43, 128
 North American Sportsman.....65, 128
 Short Track Truck.....51, 128
 Street Stock.....128
 Dirt Grand National.....128
 TA2 Road Racing.....105

Bumpers, Rear

ABC NextGen.....19, 136
 ABC Greenhouse.....27, 136
 ABC Traditional Roof.....35, 136

NextGen Late Model Stock Car.....43, 136
 North American Sportsman.....65, 136
 Short Track Truck.....51, 136
 Street Stock.....136
 Dirt Grand National.....136
 TA2 Road Racing.....105

Bumper Covers, Rear

ABC NextGen.....18
 ABC Greenhouse.....26
 ABC Traditional Roof.....34
 NextGen Late Model Stock Car.....42
 North American Sportsman.....64
 Short Track Truck.....50
 Street Stock.....72
 Dirt Grand National.....94
 TA2 Road Racing.....98, 100, 102
 Universal Short Track.....148-150

Bumper Mounting Kits

Front.....19, 27, 35, 43, 51, 65, 128
 Complete Kit.....128
 Replacement Kit.....128
 Rear.....19, 27, 35, 51, 65, 136
 Height Adjustable.....136
 Non-Adjustable.....136

C

Carbon Fiber Flat Sheets.....113, 118
Chassis Clamps.....145
Clecos & Pliers.....141
Cockpit Deflector (Dirt Late Model).....85
Cold Air Boxes
 2 Barrel.....135
 4 Barrel.....135
Cowl Panel & Cowl Air Inserts
 ABC NextGen.....18, 135
 ABC Greenhouse.....26, 135
 ABC Traditional Roof.....34, 135
 North American Sportsman.....64, 135
 Short Track Truck.....50, 135
Cowl Air Deflector.....26, 34, 135
Cowl Bracket Tabs.....135

D

Dash
 Camaro Pro Stock/Pro Mod.....108
 Mustang Pro Stock/Pro Mod.....109
Deck Lid
 ABC NextGen.....18
 ABC Greenhouse.....26
 ABC Traditional Roof.....34
 NextGen Late Model Stock Car.....42
 North American Sportsman.....64
 Street Stock.....72
 Dirt Grand National.....94
 Camaro Pro Stock/Pro Mod.....108
 Mustang Pro Stock/Pro Mod.....109
 TA2 Road Racing.....98, 100, 102
Deck Lid Bracket.....137

Deck Lid Filler Panel

ABC Traditional Roof.....34
 Street Stock.....72
 Dirt Grand National.....94

Deck Lid Height Slider Kit.....137

Deck Lid Hold Down Strip

ABC NextGen.....18, 137
 ABC Greenhouse.....26, 137
 ABC Traditional Roof.....34, 137
 NextGen Late Model Stock Car.....42, 137
 North American Sportsman.....64, 137

Doors

ABC NextGen.....18
 ABC Greenhouse.....26
 ABC Traditional Roof.....34
 Dirt Late Model.....78, 79, 81
 Dirt Modified.....89
 NextGen Late Model Stock Car.....42

North American Sportsman.....64
 Short Track Truck.....50
 Pavement Modified.....56
 Street Stock.....72
 Dirt Grand National.....94
 Camaro Pro Stock/Pro Mod.....108
 Mustang Pro Stock/Pro Mod.....109
 TA2 Road Racing.....98, 100, 102
Drill Bit Kit.....141

E

Escape Hatch (Top Alcohol Funny Car).....116

F

Fenders

ABC NextGen.....18
 ABC Greenhouse.....29
 ABC Traditional Roof.....34
 NextGen Late Model Stock Car.....42
 North American Sportsman.....64
 Short Track Truck.....50
 Street Stock.....72
 Dirt Late Model.....78, 79
 Dirt Grand National.....94
 TA2 Road Racing.....98, 100, 102

Front Clip (Body Section)

Camaro Pro Stock/Pro Mod.....108
 Mustang Pro Stock/Pro Mod.....109

G

Graphic ID Kits (Nose & Bumper Cover)

ABC NextGen.....19
 ABC Greenhouse.....27
 ABC Traditional Roof.....35
 NextGen Late Model Stock Car.....43
 North American Sportsman.....65
 Short Track Truck.....51
 Street Stock.....72, 75
 Dirt Late Model.....85
 Dirt Grand National.....94
 Camaro Pro Stock/Pro Mod.....108
 Mustang Pro Stock/Pro Mod.....109
 Camaro Top Alcohol Funny Car.....116
 TA2 Road Racing.....98, 100, 102
 Universal Short Track.....148-151

Greenhouse (Front & Rear)

ABC NextGen.....18
 ABC Greenhouse.....26
 NextGen Late Model Stock Car.....42
 North American Sportsman.....64
 Short Track Truck.....50
 TA2 Road Racing.....98, 100, 102

H

Headlight Lens Covers

Camaro Pro Stock/Pro Mod.....108
 Mustang Pro Stock/Pro Mod.....109

Heat Shield

Cold Air Box Kit.....135
 5' x 26" Length Sheet.....135

Headlight Decals.....151

Hood

ABC NextGen.....18
 ABC Greenhouse.....26
 ABC Traditional Roof.....34
 NextGen Late Model Stock Car.....42
 North American Sportsman.....64
 Short Track Truck.....50
 Pavement Modified.....56
 Street Stock.....72
 Dirt Late Model.....78, 79, 82
 Dirt Grand National.....94
 TA2 Road Racing.....98, 100, 102

Hood Hinge.....131

Hood Pin Brackets

ABC NextGen.....19, 129

ABC Greenhouse.....	27, 129
ABC Traditional Roof.....	35, 129
NextGen Late Model Stock Car.....	43, 129
North American Sportsman.....	65, 129
Short Track Truck.....	51, 129
Street Stock.....	129
Dirt Grand National.....	129
TA2 Road Racing.....	105
Hood Pin Kits.....	19, 27, 35, 43, 51, 65, 129
Hood Prop.....	131
Hood Scoops	
Dirt Late Model.....	80
Dirt Modified.....	90
Pavement Modified.....	56

M	
Mirror.....	105, 146
Mounting Bracket.....	146

N	
Noses	
ABC NextGen.....	18
ABC Greenhouse.....	26
ABC Traditional Roof.....	34
NextGen Late Model Stock Car.....	42
North American Sportsman.....	64
Short Track Truck.....	50
Pavement Modified.....	56
Outlaw Late Model.....	60
Street Stock.....	72
Dirt Late Model.....	78, 79
Dirt Modified.....	89
Dirt Grand National.....	94
TA2 Road Racing.....	98, 100, 102
Outlaw Late Model.....	60

Nose Filler Panel	
Pavement Modified.....	56
Dirt Late Model.....	80
Dirt Modified.....	88

Nose Screens 19, 27, 35, 43, 51, 60, 65, 75, 104, 151	
--	--

Nose Support, Lower	
Dirt Late Model.....	83
Dirt Modified.....	94
Outlaw Late Model.....	60
Nose Support Bracket.....	130

O	
Oil Cooler Scoop	
Dirt Late Model.....	83
Dirt Modified.....	90

P	
Parachute Boxes (Top Alcohol Funny Car).....	116
Polycarbonate Flat Sheets.....	123

Q	
Quarter Panels	
ABC NextGen.....	18
ABC Greenhouse.....	26
ABC Traditional Roof.....	34
NextGen Late Model Stock Car.....	42
North American Sportsman.....	64
Pavement Modified.....	56
Street Stock.....	72
Dirt Grand National.....	94
Dirt Late Model.....	78, 79, 81
Dirt Modified.....	89
TA2 Road Racing.....	98, 100, 102

Quarter Window Panel (Dirt Grand National).....	94
--	-----------

R	
Radiator Ducts.....	132-133
Rear Cab Filler.....	50
Rear Clip (Body Section)	
Camaro Pro Stock/Pro Mod.....	108
Mustang Pro Stock/Pro Mod.....	109
Rear Deck Mounting Kit.....	19, 27, 35, 43, 65, 137
Rear Filler Panel	
Short Track Truck.....	50
Pavement Modified.....	56
Referee 2.0.....	22, 30, 38, 46
Laser Measurement Assembly.....	22, 30, 38, 46
Wheel Locator with Magnets.....	22, 30, 38, 46
Right Side Door Support.....	19, 27, 35, 51, 141
Rivets.....	126
Rocker Panels.....	18, 26, 34, 42, 50, 56, 60, 64, 78, 79, 84, 94, 139

Roof	
ABC Traditional Roof.....	34
Pavement Modified.....	56
Street Stock.....	72
Dirt Late Model.....	78, 79, 82
Dirt Grand National.....	92
Roof Caps (Dirt Late Model).....	78, 79, 82
Roof Locating Fixture.....	22, 30, 46, 68
Rub Rail, Polycarbonate.....	139

S	
Sail Panels	
Outlaw Late Model.....	50
Pavement Modified.....	56

Spill Plates	
Camaro Pro Stock/Pro Mod.....	108
Mustang Pro Stock/Pro Mod.....	109
Camaro Top Alcohol Funny Car.....	116

Splitter	
TA2 Road Racing.....	105

Spoilers	
ABC NextGen.....	18, 138
ABC Greenhouse.....	26, 138
ABC Traditional Roof.....	42, 138
NextGen Late Model Stock Car.....	42, 138
North American Sportsman.....	64, 138
Short Track Truck.....	50, 138
Pavement Modified.....	56, 138
Street Stock.....	72, 138
Dirt Grand National.....	92, 138
Camaro Pro Stock/Pro Mod.....	108
Mustang Pro Stock/Pro Mod.....	109
Spoiler Mounting Kit.....	138

T	
Tail Light Covers (Mustang Pro Stock/Pro Mod).....	109
Templates	
ABC NextGen.....	23
ABC Greenhouse.....	31
ABC Traditional Roof.....	39
NextGen Late Model Stock Car.....	47
North American Sportsman.....	68
Short Track Truck.....	53
Camaro Pro Stock/Pro Mod.....	111
Mustang Pro Stock/Pro Mod.....	111
TA2 Road Racing.....	99, 101
Tethered Burst Panel (Top Alcohol Funny Car).....	116

U	
Universal Body Mounting Kit.....	19, 27, 35, 43, 65,
Universal Tubing Kit.....	143

V	
Valance, Lower Aero	
Dirt Late Model.....	78, 79
Dirt Modified.....	88
Valance, Lower Aero Support.....	89

W	
Washers.....	126
Wear Strips.....	19, 27, 35, 43, 65, 127
Wheel Flares	
Dirt Modified.....	91
Pavement Modified.....	56

Windshields	
ABC NextGen.....	18
ABC Greenhouse.....	26
ABC Traditional Roof.....	34
NextGen Late Model Stock Car.....	42
North American Sportsman.....	64
Short Track Truck.....	50
Pavement Modified.....	56
Street Stock.....	72
Camaro Pro Stock/Pro Mod.....	108
Mustang Pro Stock/Pro Mod.....	109
Camaro Top Alcohol Funny Car.....	116
TA2 Road Racing.....	98, 100, 102
Outlaw Late Model.....	60

Windshield Braces.....	See Braces
Window Braces.....	See Braces

Window Cleaner.....	147
Window, Door.....	108, 109, 116
Window, Door Vent.....	19, 27, 35, 65, 98, 100, 146
Window Installation Kit....	19, 27, 35, 43, 51, 65, 112, 140
Window Countersink Drill Bit.....	140

Window, Quarter	
ABC NextGen.....	18
ABC Greenhouse.....	26
ABC Traditional Roof.....	34
NextGen Late Model Stock Car.....	42
North American Sportsman.....	64
Pavement Modified.....	56
Street Stock.....	72
Camaro Pro Stock/Pro Mod.....	108
Mustang Pro Stock/Pro Mod.....	109
TA2 Road Racing.....	98, 100, 102
Outlaw Late Model.....	60

Window, Rear	
ABC NextGen.....	18
ABC Greenhouse.....	26
ABC Traditional Roof.....	34
NextGen Late Model Stock Car.....	42
North American Sportsman.....	64
Short Track Truck.....	50
Outlaw Late Model.....	60
Pavement Modified.....	56
Street Stock.....	72
Camaro Pro Stock/Pro Mod.....	108
Mustang Pro Stock/Pro Mod.....	109
TA2 Road Racing.....	98, 100, 102
Windows, Universal Aftermarket.....	119
Windows, Drag Racing Aftermarket.....	119
Windows, Factory Stock.....	119
Windows, Custom.....	121

GO TO FIVESTARBODIES.COM

TERMS &



CONDITIONS

SHIPPING



INFORMATION

Meet The Five Star

SALES & MARKETING TEAM

Thanks to the dedication of our employees, you, our valued customer can be assured of receiving a level of personalized service unsurpassed in the industry!



» **BRIAN HOPPE**
Key Accounts Manager
Team Member Since 2019



» **CAMERON FRIEDEN**
Sales / Customer Service
Team Member Since 2019



» **RICH WATSON**
Sales / Customer Service
Team Member Since 2019



» **CHRIS WIESS**
Sales / Customer Service
Team Member Since 2019



» **DAN ROBINSON**
Sales / Customer Service
Team Member Since 2022



» **DANIEL SANCHEZ**
Marketing Coordinator
Team Member Since 2021



Five Star Family Values

DRIVE OUR BUSINESS TOWARDS SUCCESS!



» ***CARL SCHULTZ***



» ***COREY SCHULTZ***



» ***GARRETT SCHULTZ***



» ***HALEY DERRICK***



» ***HEIDI SCHULTZ***

One of our great sources of pride at Five Star is the fact that we are a family-owned business. Our values as a family help guide our management of the business, and Carl takes great joy in knowing the company he has led to date is in good hands going forward. Each family member takes an active role in the day-to-day operations and looks forward to building on the legacy Carl has built for years to come.

We use the values of the Schultz Family as a guiding philosophy for running the business. These values are as follows:

CUSTOMER FOCUS

Understanding & fulfilling the needs of our customers to deliver exceptional experiences & build long-lasting relationships.

EXCELLENCE

Fueling individuals to put in the necessary effort and perseverance to succeed.

DEDICATION

Fueling individuals to put in the necessary effort and perseverance to succeed.

INNOVATION

Progress, pushing boundaries, and creating groundbreaking solutions that shape the future.

WINNING

Resilience, determination, propelling individuals to overcome challenges and achieve their goals.

We are committed to these values and they are reflected in every area of our lives & how we do business. The adoption of these core values is essential to executing our strategy and ensuring a work environment that supports The Company's objectives and inspires employees to new levels of productivity, helping them achieve their professional goals. We are confident in our ability to execute on our strategies making Five Star a fun, rewarding place to work.





46 YEARS
OF THE MOST ADVANCED BODY TECHNOLOGY



PO BOX 700 | 8899 368th AVE | TWIN LAKES, WI

262 » 877 » 2171

FIVESTARBODIES.COM • FIVESTARFABRICATING.COM • MD3RACE.COM