



TOP ALCOHOL FUNNY CAR

OFFICIAL GM LICENSED CHEVROLET CAMARO BODY

The perfect blend of speed and style, officially recognized for its authenticity & excellence in the world of drag racing.





» **ALL CARBON FIBER CONSTRUCTED BODY:**

- » Body mounting tabs laminated into the structure for ease of installation
- » Fits up to 125" wheelbase chassis
- » Weighs under 90 lbs
- » Body comes with a gray ready to paint surface finish

CAMARO FUNNY CAR BODY & WINDOWS

COMPLETE FUNNY CAR BODY SOLD THROUGH CHEVROLET PERFORMANCE

» BILL SCHEMERS: 810.397.9688 EMAIL: BILL.S@TGIDIRECT.COM

COMPLETE CAMARO FUNNY CAR BODY

Includes Tethered Burst Panel, & Escape Hatch	GM 88958780	*CALL
---	-------------	-------

REPLACEMENT PANELS & WINDOWS

Tethered Burst Panel	GM 88958780-B	\$518
Escape Hatch	GM 88958780-H	\$368
Spill Plate Set (INCLUDES LEFT & RIGHT SPILL PLATES & SPILL PLATE ANGLES)	GM 88958780-S	\$1,297
Parachute Boxes, pair (INCLUDES LEFT & RIGHT)	GM 88958780-P	\$661
Windshield, laminated, mar-resistant coated, .265", cut to fit, beveled, countersunk	68131-63558	\$920
Windshield, mar-resistant coated, 1/4", cut to fit, beveled	68131-63452	\$503
Windshield, mar-resistant coated, 3/16", cut to fit, beveled	68131-63352	\$441
Windows, Door, pair, mar-resistant coated, 1/8", cut to fit, beveled	68131-62252	\$242



UPGRADE TO FIVE STAR'S EXCLUSIVE LAMINATED WINDOW

- » Multi-layer laminated material deflects heavy impact for enhanced driver safety
- » Similar thickness to monolithic (single-layer) polycarbonate windows
- » The BEST OPTICAL QUALITY window available
- » High tech protective coatings applied
- » CNC machined and drilled for exact fit
- » Available exclusively from Five Star
- » Mandated windshield material used for all top NASCAR divisions

VINYL BODY ID GRAPHIC ID KITS FOR A REALISTIC OEM LOOK!

PRINTED ON OUTDOOR DURABLE HIGH-TACK VINYL • GLOSSY LAMINATED SURFACE PROVIDES EXCELLENT PROTECTION



CHEVROLET CAMARO

Body ID Kit	68131-44382	\$74
-------------	-------------	------

KIT INCLUDES: NOSE, TAIL, SWEEPS, WINDOW BLACKOUTS

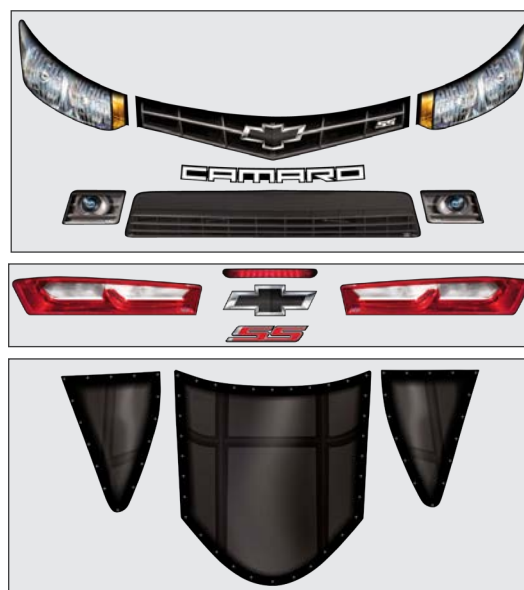

'15 CHEVROLET CAMARO

Body ID Kit	68131-44381	\$74
-------------	-------------	------

KIT INCLUDES: NOSE, TAIL, SWEEPS, WINDOW BLACKOUTS

PREMIUM CARBON FIBER FLAT SHEETS



- » True cosmetic carbon fiber surface finish
- » Flat sheets allow you to custom fit your needs
- » Very high strength to weight ratio & heat tolerance
- » Excellent vibration damping characteristics
- » Laminated for additional strength & durability
- » Perfect for Interior accent panels

**2'x4' & 4'x8' FLAT SHEETS
READY TO CUT & FIT!**

STANDARD WEIGHT CARBON FIBER FLAT SHEETS

» Sheets laminated with 2 layer carbon fiber 1 layer woven fiberglass unless otherwise noted

090-04412	.040" thick, 2'x4'	\$171
090-00412	.040" thick, 4'x8' (1 LAYER CARBON FIBER 2 LAYER WOVEN FIBERGLASS)	\$673
090-00421	.040" thick, 4'x8'	\$740
090-00612	.062" thick, 4'x8'	\$771

LIGHTWEIGHT CARBON FIBER FLAT SHEETS

» Multi layer laminate consisting of 100% carbon fiber to create the lightest panel possible

090-04430	.040" thick, 2'x4'	\$213
090-00220	.028" thick, 4'x8'	\$634
090-00430	.040" thick, 4'x8'	\$797

CAMARO FUNNY CAR

BODY DIMENSIONS

NO.	MEASUREMENT LOCATION	MEASUREMENT
1.	Ground clearance; from leading edge of body to 12" behind centerline of front spindle	3" min
2.	Ground clearance; from 12" behind centerline of front axle to the rear of the car	2" min
3.	Vertical height; from centerline of spindle to wheel opening	5" min
4.	Front over hang; from leading edge of body to centerline of the front spindle	40" max
5.	Cowl height; in front of injector hat	5" max
6.	Injector opening width	26" max
7.	Body burst panel; in front of injector hat	288 in ² min
8.	Window height	OEM minus no more than 2"
9.	Fire extinguisher window opening; both sides	6" Diameter min
10.	Center or rear axle to trailing edge of rocker panel	18" min
11.	Vertical height from center line of rear axle to wheel opening	8" min
12.	Height; trailing edge of rear bumper to the ground	29" max
13.	Height; bumper vertical surface	3" min
14.	Wheelbase; right/passenger side: max 2" difference between	100" min / 125" max
15.	Wheelbase; left/driver side: max 2" difference between	100" min / 125" max
16.	Rear over hang; centerline of rear axle to trailing edge of rear bumper	54" max
17.	Bumper opening; for parachute shroud lines	30" x 4" max
18.	Roof width	32" min
19.	Roof length; top of front windshield to top of rear window	OEM +/- 4"
20.	Escape hatch length	18" min
21.	Escape hatch width	17" min
22.	Body width; at centerline of front axles - max difference 6"	60" min
23.	Body width; at centerline of rear axles - max difference 6"	60" min
24.	Spoiler width; outside	54" max
25.	Spoiler over hang; centerline of rear axle to trailing edge of spoiler	56" max
26.	Spoiler height; above top of roof; may not be above spill plates	4" max
27.	Spill plate height; above top roof	5" max
28.	Lip around body; fenders, bumpers, rocker panels	1" max
29.	Hinged tail light openings	100 in ² max each side
30.	Spill plate over hang; centerline of rear axle to trailing edge of spill plates	60" max
31.	Rear deck between spill plates; depth below rear deck outside spill plates	1.75" max
32.	Top of spill plate to ground; height	60" max

FIVE STAR BODIES ARE DESIGNED TO MAINTAIN PRECISE FIT WITH OPTIMIZED AERODYNAMICS!

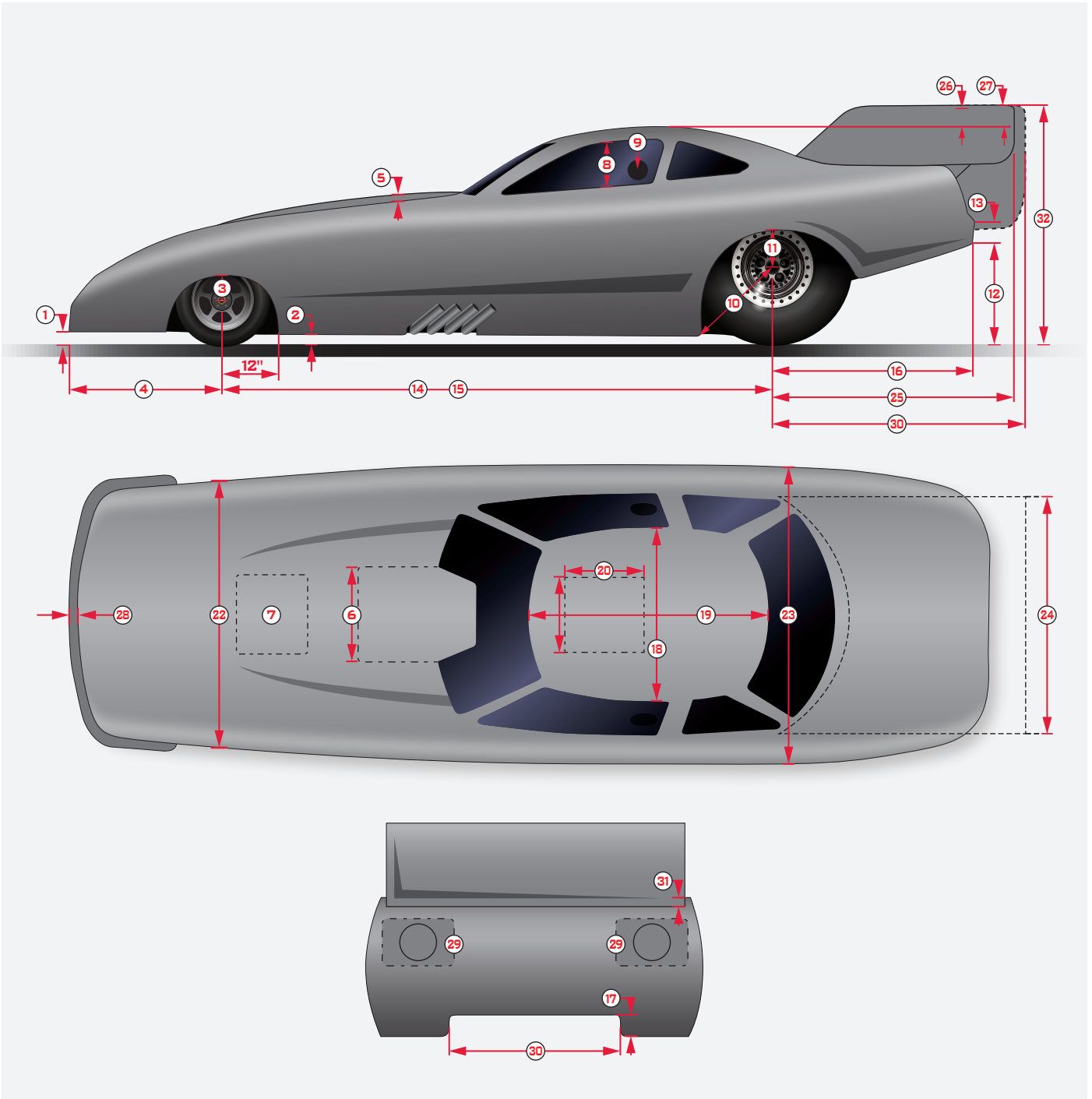

» DOWNLOAD OFFICIAL RULEBOOK @ NHRACER.COM

HAVE A TECH QUESTION? THE NHRA ALSO HAS RESOURCES FOR ALL NHRA DIVISIONS TO ANSWER YOUR QUESTIONS ABOUT SAFETY, RULES, AND COMPLIANCE. VISIT NHRACER.COM!



PRICING SUBJECT TO CHANGE WITHOUT NOTICE

ABC LMSC TRUCK RAYMODIFIED OUTLAW LATE MODEL SPORTSMAN STREET STOCK M3 LATE MODEL M3 MODIFIED DIRT GRAND NATL TAZ PRO STOCK/MOD FUNNY CAR WINDOWS ACCESSORIES



BODY MOUNTING TOOLS, BRACING & ACCESSORIES

*PRODUCTS ESSENTIAL FOR A COMPLETE, CLEAN,
PROFESSIONAL-LOOKING RACE CAR*



- » **MOUNTING TOOLS:** Facilitate a professional body installation, & replace panels throughout the season quick & hassle-free
- » **UNIVERSAL BRACING:** Support body panels with these lightweight components essential to achieving astounding aerodynamics
- » **ACCESSORIES:** Everything you need to give you race car that finishing touch!

FIVE STAR PREMIUM AVEX STYLE MULTI-GRIP RIVETS *THE BEST QUALITY ON THE MARKET*

- » Five Star Rivets have a super-tight grip & won't spin while drilling
- » Grip range of up to 3/16" for 1/8" rivets & up to 1/2" for 3/16" rivets
- » Use long shank rivets for fastening fender, door, & windshield post together
- » Sold in quantities of 100 & 500; large head & small head with choice of 1/8" unpainted or 3/16" unpainted, white, black, blue, red



SIZE/DESCRIPTION	QTY	SMALL	LARGE	
3/16", color	100	814x-100S	814x-100L	\$17
3/16", unpainted	100	816-100S	816-100L	\$17
3/16" long shank	100	816A-100S	N/A	\$19
3/16", color	500	814x-500S	814x-500L	\$68
3/16", unpainted	500	816-500S	816-500L	\$55
1/8", unpainted	100	815-100S	815-100L	\$13
1/8", unpainted	500	815-500S	815-500L	\$50

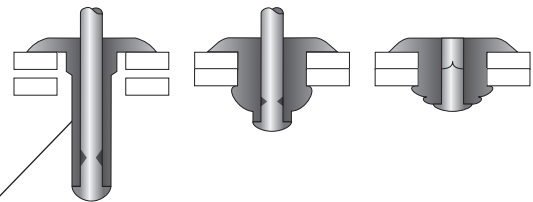

Provide a secure installation of your body panels with Five Star Rivets & Washers!

Five Star Rivets pull much tighter than other, cheaper rivets.

Washers are oversized to fit with Five Star Rivets and keep rivets tight no matter how much vibration

FIVE STAR PREMIUM WASHERS

- » Five Star Premium Washers are lightweight & available in 3 sizes
- » Recommended for all plastic & composite body panels to keep them tight & prevent rivets from pulling out

TYPE	SIZE (I.D.)	SIZE (O.D.)	QTY		
Standard	1/8"	3/8"	100	817-100A	\$9
Standard	1/8"	3/8"	500	817-500A	\$25
Standard	3/16"	1/2"	100	818-100A	\$9
Standard	3/16"	1/2"	500	818-500A	\$25
Large	3/16"	3/4"	100	818-100AL	\$9
Large	3/16"	3/4"	500	818-500AL	\$25

HIGH-IMPACT PLASTIC WEAR STRIPS

- » Height adjustable to seal the nose to the track to optimize aero & protection from wear
- » CNC-machined from Five Star's exclusive durable plastic
- » 2-piece kit fits either side
- » Install with Five Star Wear Strip Attach Kits
- » Available in 10 colors

ABC NextGen, NextGen LMSC Wear Strips	116" x 1-7/8"	11002-41551-x	\$35
ABC, LMSC, Straight-up Metal, Dirt Grand National Wear Strips	112" x 2-3/4"	000-400-x	\$35
S2 Sportsman Wear Strips	111" x 3"	664-400-x	\$42
Classic Street Stock (N/A IN FLUORESCENT COLORS)	120" x 5"	600-400-x	\$41
MD3 Street Stock, '88 Monte Carlo Wear Strips	119" x 3"	021-400-x	\$41
Modern Style Street Stock, North American Sportsman Wear Strips	107" x 3"	20002-41551-x	\$38

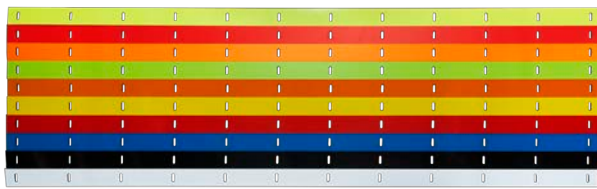

11002-41551-X

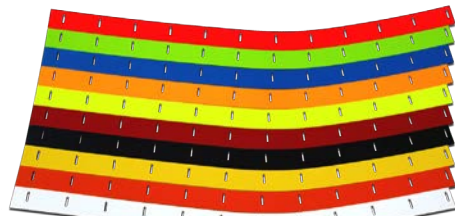

000-400-X



11002-41551-Y YELLOW WEAR STRIPS FULLY INSTALLED WITH 00001-72651 UNIVERSAL BODY MOUNTING KIT

KITS SPEED UP WEAR STRIP INSTALLATION & ALLOW FOR ADJUSTABILITY OF WEAR STRIP IF NEEDED



FULLY ASSEMBLED PLASTIC

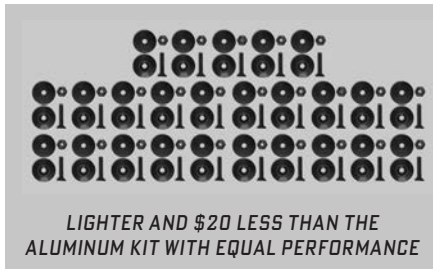

LIGHTER AND \$20 LESS THAN THE ALUMINUM KIT WITH EQUAL PERFORMANCE



FULLY ASSEMBLED ALUMINUM

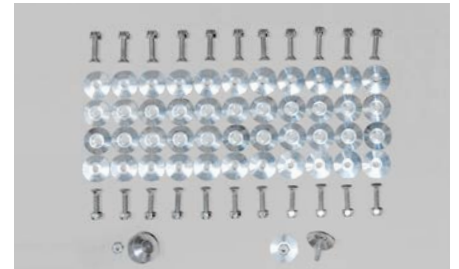

UNIVERSAL BODY MOUNTING KITS

- » Universal fit that can be used anywhere on a race car
- » Plastic Kit comes in all black & features Delrin washers that withstand repeated impact & stress
- » **Aluminum Kit includes:** 25 lightweight machined aluminum inner & outer 1" diameter washers, 25 nuts & 25 bolts. Kit weighs 12 oz
- » **Plastic Kit includes:** 25 ultra-durable plastic inner & outer 1" diameter washers, 25 lightweight aluminum nuts & 25 bolts.
- » Kit weighs 7 oz

Aluminum: 25 sets (FULL INSTALLATION)	000-400K	\$49
Plastic: 25 sets (FULL INSTALLATION)	00001-72651	\$29

ABC LMSC TRUCK RAY/MODIFIED OUTLAW/LATE MODEL SPORTSMAN STREET STOCK MD3 LATE MODEL MD3 MODIFIED DIRT GRAND NATL TAZ PRO STOCK/MOD FUNNY CAR WINDOWS ACCESSORIES

FRONT BUMPERS

- » Formed using CNC progressive tube bending technology
- » Fits the exact contour of Five Star noses for maximum protection and ease of installation
- » Formed from 1-3/4" OD round steel tubing
- » For a complete secure mount, it is recommended to install your bumpers with Five Star's Front Bumper Mounting Kits

ABC NEXTGEN		
Front, .065" steel	11002-71182	\$48
Front, .095" steel	11002-71185	\$48
Front, .095" steel (12" EXT RIGHT SIDE)	11002-71188	\$56
NEXTGEN LMSC		
Front, .065" steel	13002-71182	\$48
Front, .095" steel	13002-71185	\$48
Front, .095" steel (12" EXT RIGHT SIDE)	13002-71188	\$56
ABC / LMSC / STRAIGHT-UP METAL		
Front, .065" steel	660-7103	\$48
Front, .095" steel	660-7103B	\$48
Front, .095" steel (12" EXT RIGHT SIDE)	660-7103C	\$56

NORTH AMERICAN SPORTSMAN		
Front .065" steel	20002-71182	\$48
STREET STOCK '88 MONTE CARLO		
Front, .065" steel	600-7103	\$48
Front, .095" steel	600-7103B	\$48
Front, .065" steel	600-7101 (SQUARE)	\$48
STREET STOCK CAMARO & MUSTANG		
Front, .065" steel	20002-71182	\$48
DIRT GRAND NATIONAL		
Front, .065" steel	700-7103	\$48
Front, .095" steel	700-7103B	\$48
SHORT TRACK TRUCK COMMON		
Front, .065" steel	21001-71162	\$48

FRONT BUMPER MOUNTING KIT (HIGHLIGHTED IN ORANGE)
WITH BLACK ADJUSTABLE BUMPER SUPPORTS



.095" STEEL BUMPER WITH
12" EXTENSION FOR
ADDITIONAL RIGHT FRONT
PROTECTION

CLOSE-UP OF
ADJUSTABLE
BUMPER SUPPORT

FRONT BUMPER MOUNTING KITS

- » Everything you need to mount the bumper to the chassis
- » Upgraded lightweight, extruded, black anodized aluminum adjustable bumper supports
- » Make quick, easy, & accurate adjustments with a 5/8" wrench
- » Universal design for all Five Star Short Track Noses
- » Fits all chassis configuration
- » **Complete Kit includes:** 2 aluminum threaded bumper support tubes; 4 clevis, eye bolts & nuts; 2 1-1/2" pieces of square tubing, notched on one end; 2 pieces of flat stock; 4 1-1/2" bolts & stover nuts, 2 pivoting chassis mounts with 2-1/2" bolts & nuts
- » **Adjustable Bumper Support Kit includes:** 2 extruded, threaded, black anodized aluminum adjustable tubes; 4 eye bolts & nuts; 4 1-1/2" bolts and stover nuts
- » **Replacement Kit includes:** 2 1-1/2" square pieces of square tubing; 2 pieces of flat stock; 1/2" nuts & bolts & mounting tabs

Complete Kit	10001-72721	\$132
Adjustable Bumper Support	10001-72733	\$29
Replacement Kit	802-4	\$87

10001-72721 | COMPLETE KIT

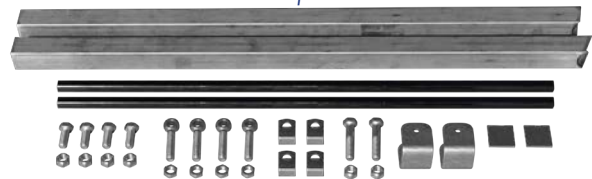

802-4 | REPLACEMENT KIT



10001-72733 | ADJUSTABLE BUMPER SUPPORTS KIT



HOOD PIN BRACKETS

- » Preformed to fit the nose & hood precisely
- » Aluminum option weighs less than half of steel
- » Both options include welded-on tabs for hood pin placement
- » Aluminum bracket includes welded on mounting tabs on each end to brace to the front bumper mounting kit for added support
- » ABC NextGen / NextGen LMSC require 4 hood pins & Old Style ABC/LMSC require 5 hood pins
- » Available in 1/2" & 3/4" options, & will work for both 1/2" & 3/8" hood pins

ABC NEXTGEN / NEXTGEN LMSC:		
3/4" OD, aluminum (COMMON)	11002-34333	\$66
3/4" OD, steel (COMMON)	11002-34331	\$35
OLDER STYLE ABC / LMSC:		
3/4" OD, aluminum (EXCLUDES FORD)	660-411A-HPB	\$66
3/4" OD, aluminum (FORD)	570-411A-HPB	\$66
3/4" OD, steel (EXCLUDES FORD)	660-411-HPB	\$35
3/4" OD, steel (FORD)	570-411-HPB	\$35
1/2" OD, steel (EXCLUDES FORD)	660-410-HPB	\$35
1/2" OD, steel (FORD)	570-410-HPB	\$35
NORTH AMERICAN SPORTSMAN:		
3/4" OD, steel	20002-34331	\$35

S2 SPORTSMAN:		
3/4" OD, steel	664-411-HPB	\$35
1/2" OD, steel	664-410-HPB	\$35
SHORT TRACK TRUCK:		
1/2" OD, steel (COMMON)	21001-34131	\$35
STREET STOCK:		
3/4" OD, steel ('88 MONTE CARLO)	600-410-HPB	\$35
3/4" OD, steel (MD3 CAMARO & MUSTANG)	20002-34331	\$35
DIRT GRAND NATIONAL:		
1/2" OD, steel (EXCLUDES FORD)	700-410-HPB	\$35
1/2" OD, steel (FORD)	703-410-HPB	\$35

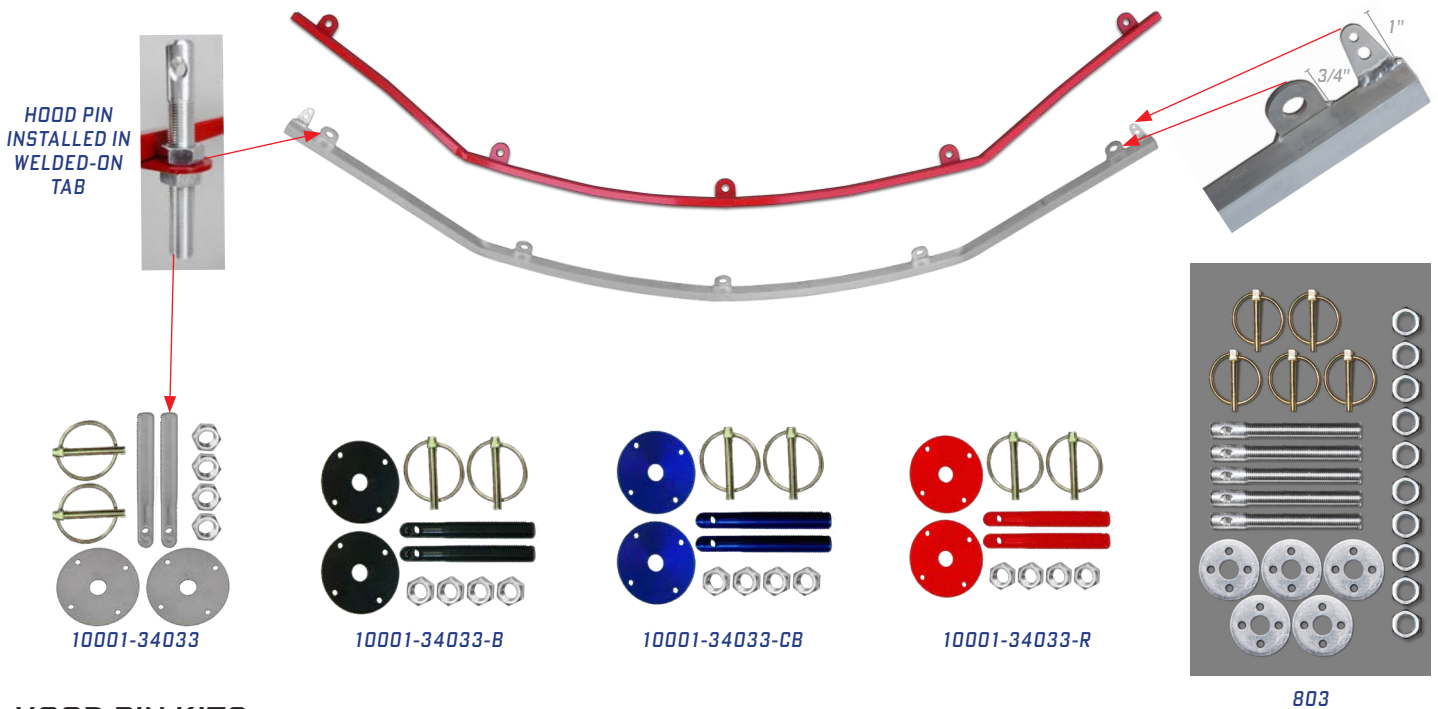

HOOD PIN KITS

- » **Secure your hood in style!**
- » **3/8" Hood Pin Kit:** 2 pack kit includes: 2 lightweight anodized & gun-drilled aluminum pins (HALF THE WEIGHT OF STANDARD), 2 aluminum scuff plates, 2 flip-over steel clips, 4 jam nuts
- » **1/2" Hood Pin Kit:** 5 pack kit includes: 5 lightweight aluminum pins, 5 aluminum scuff plates, 5 flip-over style steel clips, 10 jam nuts

3/8" Hood Pin Kit, Silver	10001-34033	\$15
3/8" Hood Pin Kit, Black	10001-34033-B	\$15
3/8" Hood Pin Kit, Red	10001-34033-R	\$15
3/8" Hood Pin Kit, Blue	10001-34033-CB	\$15
1/2" Hood Pin Kit, 5 pack	803	\$38
1/2" Scuff Plate, aluminum	803-PS	\$2

ABC LMSC TRUCK RAV/MODIFIED OUTLAW/LATE MODEL SPORTSMAN STREET STOCK MD3 LATE MODEL MD3 MODIFIED DIRT GRAND NAT'L T&2 PRO STOCK/MOD FUNNY CAR WINDOWS ACCESSORIES



FULLY INSTALLED UNDERNEATH THE LOWER NOSE VALANCE (LEFT SIDE SHOWN)



ALUMINUM
11002-75733

42-1/2"

LOWER NOSE SUPPORT BRACKET

- » Mounts under the lower valance to maintain strength & structural integrity for the nose under high speeds
- » Choose from a lightweight aluminum or steel bracket
- » Fits left & right half of nose
- » **2-piece kit includes: 2 brackets with 2 attached mounting tabs for ease of installation**

Aluminum	11002-75733	\$49
Steel	11002-75731	\$44

FITS THESE BODY STYLES: ABC NEXTGEN, NEXTGEN LMSC



000-500: MOUNT TO INSIDE OF WEAR STRIPS WITH A FIVE STAR UNIVERSAL BODY MOUNTING KIT



11002-75333: MOUNT VERTICALLY ON NOSE SIDE

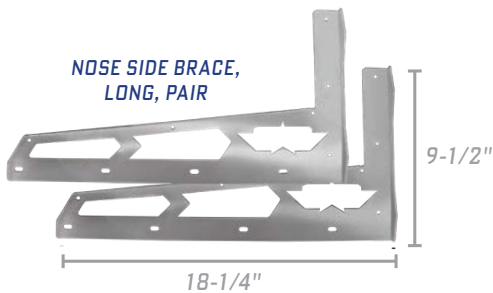

NOSE SIDE BRACE, LONG, PAIR

9-1/2"

18-1/4"



9-7/8"

NOSE SIDE BRACE, SHORT, PAIR

2"

ALUMINUM NOSE SIDE BRACES

- » Provides structure to an aero critical part of the car
- » Laser-cut aluminum is pre-drilled for riveting to the nose & for mounting body braces
- » Works great with Five Star's Premium Adjustable Body Braces (PN 10001-759XX)
- » Each pair weighs less than a pound

Nose Side Brace, Long, pair	000-500	\$39
-----------------------------	---------	------

FITS THESE BODY STYLES: OLDER STYLE ABC AND OLDER STYLE LMSC, FIBERGLASS SPORTSMAN, STRAIGHT UP METAL, DIRT GRAND NATIONAL, MINI STOCK MUSTANG

Nose Side Brace, Short, pair	11002-75333	\$14
------------------------------	-------------	------

FITS THESE BODY STYLES: ABC NEXTGEN, NORTH AMERICAN SPORTSMAN, NEXTGEN LMSC, SHORT TRACK TRUCK

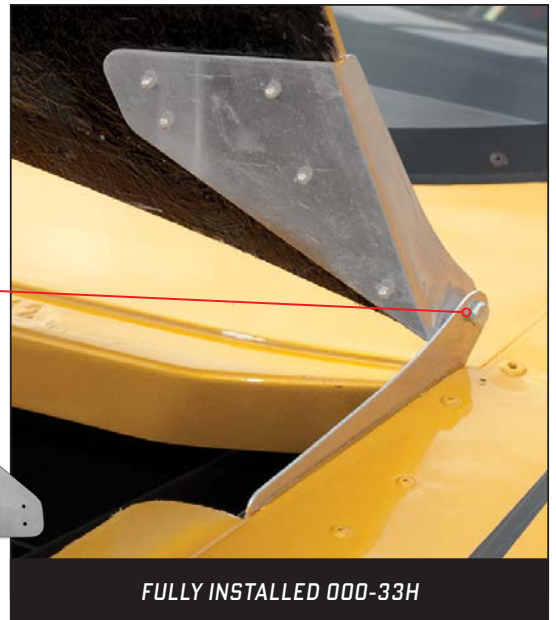
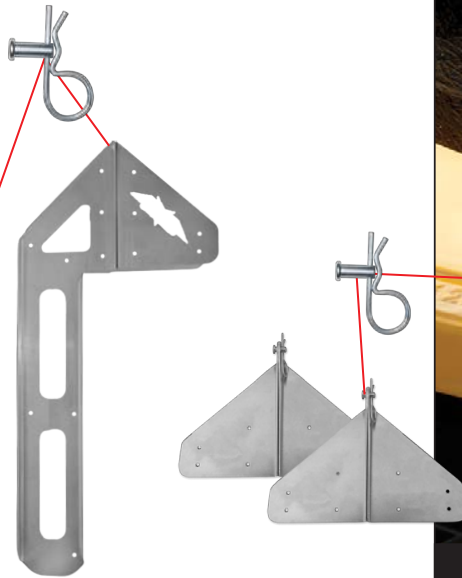

ALUMINUM HOOD HINGE KITS

- » Hinged hoods create easy access to the engine compartment
- » Long Hinge Kit includes: Laser cut aluminum hinge, pin, & clip assembly. 1 kit is required to complete the installation of a hood
- » Short Hinge Kit includes: Laser cut aluminum hinge, pin, & clip assembly. 2 kits are required to complete the installation of a hood

Hood Hinge, short	000-33H	\$16
Hood Hinge, long	11002-73333	\$39
Replacement Pin & Clip	000-33HP	\$4

ALUMINUM HOOD PROP

- » Makes for the easiest access to the engine compartment
- » Made of machined lightweight aluminum
- » Used for hinged hoods
- » Sold as a pair, 2 needed for installation

Hood Prop, pair	000-3400	\$67
-----------------	----------	------

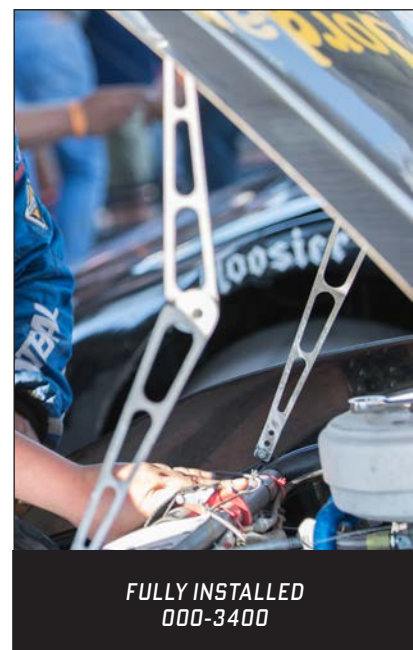



000-408 FULLY INSTALLED



11002-42151 FULLY INSTALLED

MOLDED PLASTIC RADIATOR DUCTS

- » Universal multi piece design for easy installation to fit any chassis and radiator size/offset
- » High air flow design
- » Premium molded plastic weighs less than 13 lbs
- » More durable and easier to install than other sheet metal air boxes
- » 100% positive seal from nose to radiator
- » Access panel for easy debris clean-out
- » 000-408 for short track bodies, includes Plastic Nose Air Inlet Extension
- » The Plastic Nose Air Inlet Extension is not needed for the ABC NextGen & Late Model Stock Car NextGen

Universal Short Track Bodies*	000-408	\$221
ABC NextGen / NextGen LMSC	11002-42151	\$185

*FITS THESE BODY STYLES: ABC, LMSC, NORTH AMERICAN SPORTSMAN, S2 SPORTSMAN, STRAIGHT-UP METAL, STREET STOCK



*NOTE: FOR COMPLETE INSTALLATION GUIDE VISIT FIVESTARBODIES.COM/RESOURCES

PLASTIC BRAKE DUCT KIT

- » Provide peak airflow to cool your brakes
- » Universal fit for all noses at correct angle; fits either side
- » Fits 3" & 4" Brake Duct hose
- » Kit includes: pre-cut stainless steel screen, rivets & washers
- » Weighs 6 oz

Brake Duct	000-412D	\$35
------------	----------	------

FITS THESE BODY STYLES: ABC NEXTGEN, ABC, NEXTGEN LMSC, LMSC, S2, SHORT TRACK TRUCK, NORTH AMERICAN SPORTSMAN, STRAIGHT-UP METAL, STREET STOCK

ONLY WEIGHS 6 OZ



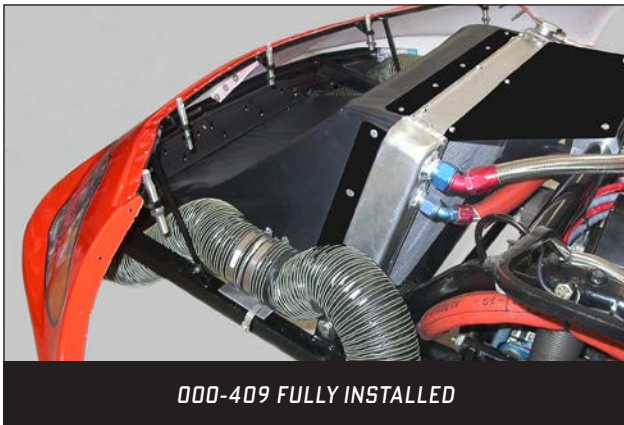

000-409 FULLY INSTALLED



STREET STOCK
FLEXIBLE RADIATOR DUCT

FLEXIBLE RADIATOR DUCTS

- » Retains air flow functionality even after frontal impact & reduces the risk of radiator damage
- » Flexible Radiator Duct replaces rigid metal ductwork with a custom canvas bag & aluminum or plastic framing
- » Long lasting & durable
- » Simple installation
- » Select your model by measuring the size of the radiator core
- » Features molded plastic radiator mounting flanges
- » Plastic Nose Air Inlet Extension (PN 000-409-NP) used for 000-409 Radiator Ducts only

Street Stock (PN 600-409)

- » Fits both '88 Monte Carlo Noses
- » Captures air from both the upper & lower nose grill openings

ABC/NORTH AMERICAN SPORTSMAN/S2/SU		STYLE/SIZE	ABC NEXTGEN/NEXTGEN LMSC	
000-409-1	\$169	Griffin, 22-3/8" x 17-7/8"	11002-42120	\$135
000-409-2	\$169	Howe, 24-1/4" x 18-1/2"	11002-42121	\$135
000-409-3	\$169	Howe, 22-1/4" x 18-3/4"	11002-42122	\$135
000-409-4	\$169	C & R, 22-1/4" x 17-3/4"	11002-42123	\$135
000-409-5	\$169	C & R, 24-1/4" x 17-3/4"	11002-42124	\$135
000-409-6	\$169	Howe, 27-1/4" x 18-1/2"	11002-42125	\$135
LMSC		STYLE/SIZE	STREET STOCK	
000-409-5	\$169	C & R, 24-1/4" x 17-3/4"	11002-42124	\$135
000-409-6	\$169	Howe, 27-1/4" x 18-1/2"	11002-42125	\$135

PLASTIC NOSE AIR INLET EXTENSION

- » Ideal for racers who build their own aluminum radiator box
- » Molded Plastic construction & weighs less than 2 lbs
- » The Plastic Nose Air Inlet Extension is not needed for the ABC NextGen & Late Model Stock Car NextGen
- » Item already included with 000-408 Molded Plastic Radiator Duct & 000-409 Flexible Radiator Duct

Plastic Nose Air Inlet Extension	000-409-NP	\$36
----------------------------------	------------	------

FITS THESE BODY STYLES: ABC, LMSC, NORTH AMERICAN SPORTSMAN, S2 SPORTSMAN, STRAIGHT-UP METAL



SHOWN MOUNTED FROM INSIDE OF NOSE

DETAILS AND



DIMENSIONS



FULLY INSTALLED COLD AIR BOX

COWL INDUCTION COLD AIR BOXES

FLOW BENCH TESTED FOR PEAK AIRFLOW

- » Advanced lightweight composite construction with flame retardant gray resin
- » Comparable in weight to carbon fiber alternatives
- » Designed for maximum airflow using air filters as short as 3"
- » Increased distributor & under hood clearance
- » Fits a standard 14" filter element

4 Barrel, 0° Angle (Offset)	10001-53401	\$568
4 Barrel, 3° Angle (Standard)	10001-53431	\$568
2 Barrel, standard	10001-53201	\$426
2 Barrel, offset	10001-53202	\$406

NOTE: FOR OLDER STYLE 51-SERIES COLD AIR BOXES CALL FIVE STAR 262.877.2171



2 BARREL COLD AIR BOX

4 BARREL AIR BOXES:

- » Available in 0° & 3° to ensure a proper, level fit
- » Feature a patented machined adapter ring for clean airflow, better fit, & durability
- » 3° Airbox is commonly used for short track Late Models
- » How to determine air box angle option:
 - » Set car at proper ride height
 - » Place angle finder on carburetor to determine which air box option fits bests



4 BARREL COLD AIR BOX

2 BARREL OFFSET AIR BOX:

- » Offset 2-barrel air box is for engines with a larger setback
- » Designed to allow the element to be flat across the back for engine setback & clearance in the cowl
- » Fits a standard 3-1/2" x 14" filter element

2 BBL AIR BOX IS DYNO TESTED

"The results were outstanding! Five Star's 2bbl Air Box was 10 HP & 16 ft lbs of torque better than the old one!"

-SHANE HARDING
HARDING MOTORSPORTS CHASSIS

PATENTED FLOW DESIGN

4 BBL UNIQUE HIGH FLOW DESIGN
CNC-machined aluminum ring (laminated into the air box) fits perfectly on carburetor to maximize airflow

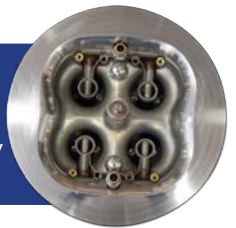

DETAILS AND



DIMENSIONS

» FOR INDIVIDUAL PART DIMENSIONS, VISIT FIVESTARBODIES.COM

REFLECTIVE HEAT SHIELD KITS

- » Thin reflective adhesive film reflects over 90% of radiant heat from the engine, up to 500°F
- » Easy to cut and install to protect any part of the race car from high heat:
 - » All Cold Air Boxes
 - » Interiors
 - » Foot Boxes
 - » Shock Canisters
 - » Fuel Filter Housings
 - » And more

Cold Air Box Kit, 4 oz	000-52HS	\$74
5'x26" Length Sheet, 3oz per ft	000-5HS	\$74



FULLY INSTALLED COLD AIR BOX KIT 000-52HS

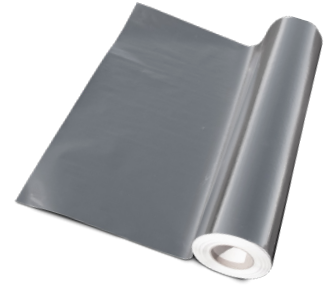

5' LENGTH SHEETS 000-5HS

ROUNDED BOTTOM | 000-5200A



SQUARE BOTTOM | 000-5100A-B



COWL AIR DEFLECTORS

- » Smoothly flows air from cowl air opening into cold air box
- » Black Ultraglass Composite
- » Rounded Bottom: 20" x 7", Square Bottom: 20-1/8" x 7-1/2"
- » Fits all air box styles listed on page 132
- » 000-5100A-B available & fits older style 51-series air boxes

Rounded Bottom	000-5200A	\$55
Square Bottom	000-5100A-B	\$70



COWL AIR INSERT | 661-5100A-X

COWL AIR INSERT

- » Designed for maximum airflow directly into the cold air box
- » Made of Ultraglass composite & oversized for left & right adjustment to properly fit the airbox
- » Opening meets all sanctioning regulations
- » Included with ABC Body Packages
- » Available in 4 colors

Cowl Air Insert	661-5100A-X	\$68	\$73
-----------------	-------------	------	------

FITS THESE BODY STYLES: ABC NEXTGEN, ABC, NORTH AMERICAN SPORTSMAN, S2, STRAIGHT-UP METAL, SHORT TRACK TRUCK

ALUMINUM COWL BRACKET TABS

- » Create a positive seal by holding hood flat at the cowl
- » Mounts along front flange of Cowl Panel
- » Fits 3/8" or 1/2" Hood Pins
- » Kit is included with cowl panels
- » Kit includes: 4 laser-cut aluminum tabs weighing 0.5 oz each

Cowl Bracket Tabs	000-510	\$13
-------------------	---------	------



REAR BUMPERS

- » Formed using CNC progressive tube bending technology
- » Fits the exact contour of Five Star noses for maximum protection and ease of installation
- » Formed from 1-3/4" OD round steel tubing
- » For a complete secure mount, it is recommended to install your bumpers with Five Star's Rear Bumper Mounting Kits

ABC NextGen, .065" steel	11002-71682	\$48	Street Stock '88 Monte Carlo, .065" steel	600-7501	\$48
NextGen LMSC, .065" steel	11002-71682	\$48	Dirt Grand National, .065" steel	570-7503	\$48
ABC / LMSC / Straight-Up Metal, .065" steel	570-7503	\$48	Short Track Truck, .065" steel	T000-7503	\$48
North American Sportsman, .065" steel	11002-71682	\$48			

REAR BUMPER FULLY INSTALLED WITH HEIGHT ADJUSTABLE MOUNTING KIT
(HIGHLIGHTED IN ORANGE)

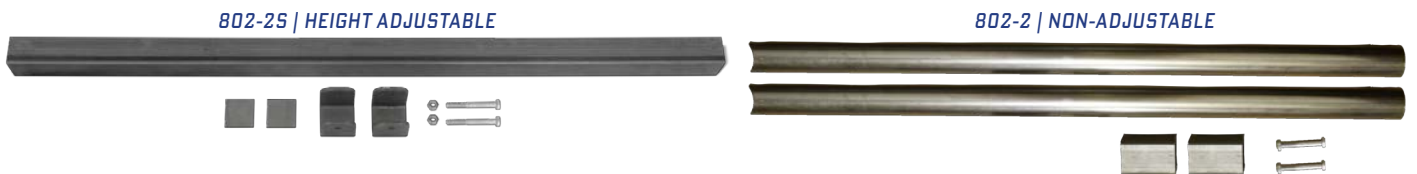
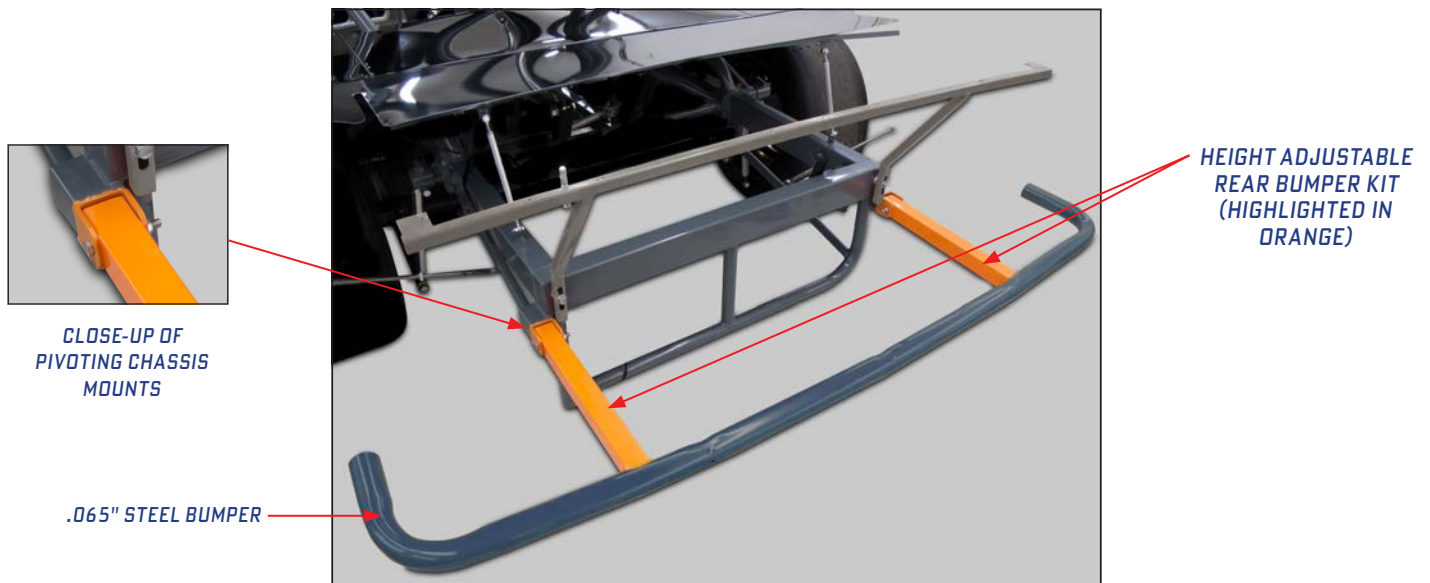

REAR BUMPER MOUNTING KITS

- » Everything you need to mount the bumper to the chassis
- » Universal design for all Five Star Short Track Noses
- » Fits all chassis configuration
- » Available in two options:
 - » **Height-Adjustable Kit:** (PN 802-2S) Allows for several different mounting options and pivots to allow precise adjustments to the height of the rear bumper cover
Kit includes: 2 pivoting chassis mounts; 1 36" long 1-1/2" square piece of tubing; 2 pieces of flat stock; 2 1/2" nuts and bolts
 - » **Non-Adjustable Kit:** (PN 802-2) Make your bumper a bolt-on component
Kit includes: 2 3' long x 1-3/4" thick pieces of round tubing, 2 pieces of .120" thick square tubing and 5/16" hex bolts & nuts

Height-adjustable Kit	802-2S	\$49
Non-adjustable Kit	802-2	\$38

STEEL REAR DECK MOUNTING KIT

- » Everything you need to properly fabricate a perfect fitting brace from the rear bumper cover & deck lid to the chassis
- » **Deck Lid Bracket:** (PN 660-450-DLB) supports your rear body clip by securing it to the rear bumper cover & quarter panel.
Kit includes: 2 tabs for hood pins; weighs 36 oz
- » **Deck Lid Height Slider Kit:** (PN 802-3) allows for easy adjustment of spoiler height with 3-1/2" of deck lid height adjustability.
Kit includes: 2 pieces slotted 3/4" square tubing, 3/8" hex bolts & nuts
- » **Deck Lid Hold-down Kit:** (NOT SOLD SEPARATELY) allows for a removable deck lid.
Kit includes: 1 aluminum deck lid hold-down strip, 2 mounting tabs, 4 jam nuts, 2 3/8" gun-drilled, anodized aluminum pins & scuff plates (SILVER), & 2 flip-over steel clips

Rear Deck Mounting Kit	660-450-RDK	\$87
Replacement Deck Lid Bracket	660-450-DLB	\$32
Replacement Deck Lid Height Slider Kit	802-3	\$16

FITS THESE BODY STYLES: ABC NEXTGEN, ABC, NEXTGEN LMSC, LMSC, NORTH AMERICAN SPORTSMAN, S2, STRAIGHT-UP METAL, STREET STOCK, DIRT GRAND NATIONAL, MINI STOCK

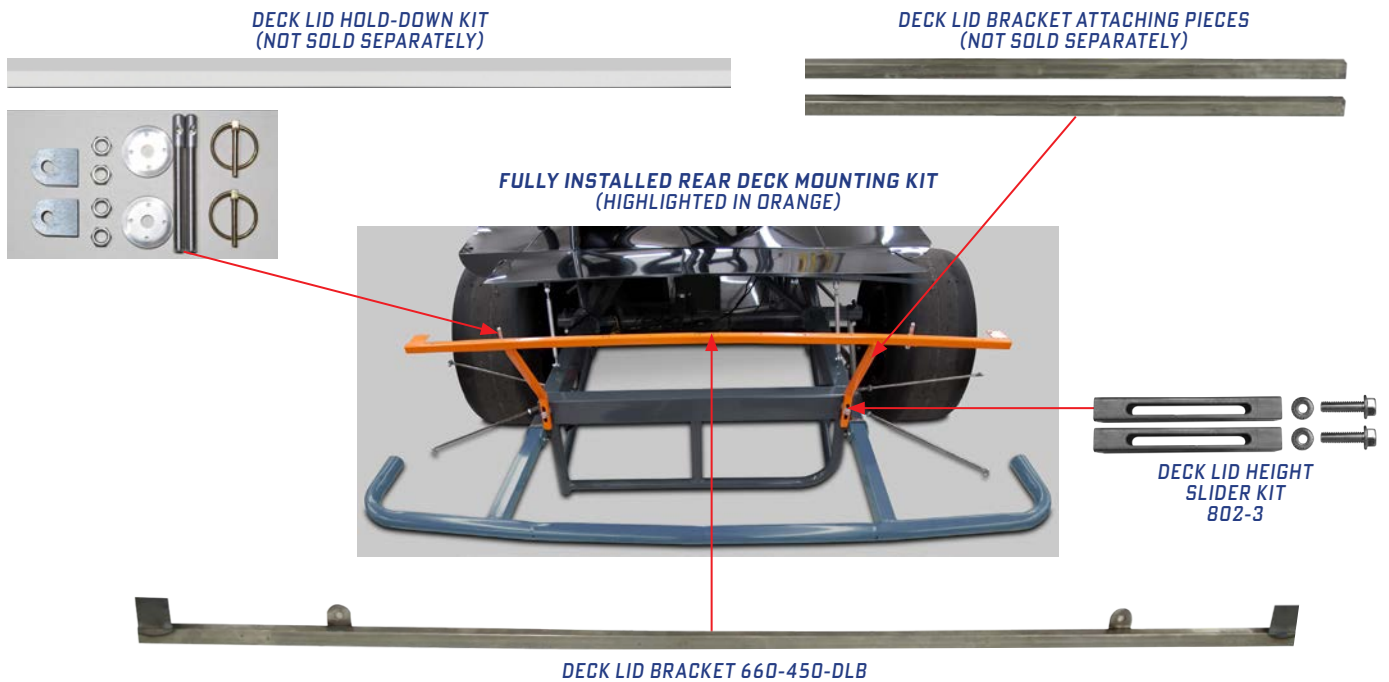

ONLY WEIGHS 17 OZ
LESS THAN HALF THE WEIGHT OF STEEL

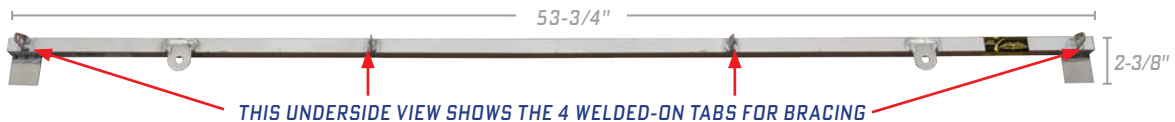

ALUMINUM DECK LID BRACKET

- » This is a premium upgrade from the steel deck lid bracket to save weight without sacrificing strength
- » Mounts to the rear bumper cover and quarter panel, includes 2 tabs for hood pins and 4 tabs for chassis mounting options
- » Complete the combination with our 3/8" Hood Pin Kit (PN 10001-34033-X)

Aluminum Deck Lid Bracket	11002-75633	\$49
---------------------------	-------------	------

FITS THESE BODY STYLES: ABC NEXTGEN, ABC, NEXTGEN LMSC, LMSC, NORTH AMERICAN SPORTSMAN, S2, STRAIGHT-UP METAL, STREET STOCK, DIRT GRAND NATIONAL, MINI STOCK



UNPAINTED BRACKETS WITH BLADES



BLACK POWDER-COATED BRACKETS WITH BLADES, FULLY INSTALLED USING 807-3 ADJUSTABLE BODY BRACES (SOLD SEPARATELY, SEE PG 141)

REPLACEMENT SPOILER BRACKETS & BLADES

- » 2-piece polycarbonate blade with 2-piece aluminum bracket, your choice of unpainted or black powder-coated
- » Available in 90, 70 and 55 degree angles

ABC NextGen / NA Sportsman	5" (90°)	5" (70°)	6-1/2" (90°)	6-1/2" (70°)			
Brackets, replacement, aluminum, 60"	11002-47369-1	11002-47367-1	11002-47369-1	11002-47367-1	\$80		
Brackets, replacement, aluminum, 64-1/2"	N/A	N/A	11002-47389-1	11002-47377-1	\$80		
Brackets, replacement, aluminum, black, 60"	11002-47369-1B	11002-47367-1B	11002-47369-1B	11002-47367-1B	\$90		
Brackets, replacement, aluminum, black, 64-1/2"	N/A	N/A	11002-47389-1B	11002-47377-1B	\$90		
Blades, replacement, polycarbonate, 60"	11002-47359-2	11002-47357-2	11002-47369-2	11002-47367-2	\$49		
Blades, replacement, polycarbonate, 64-1/2"	N/A	N/A	11002-47389-2	11002-47387-2	\$59		
ABC / S2 / SU-Metal	5" (90°)	5" (70°)	5" (55°)	6-1/2" (90°)	6-1/2" (70°)	6-1/2" (55°)	
Brackets, aluminum	661-6739-1	661-6737-1	661-6735-1	661-6739-1	661-6737-1	661-6735-1	\$80
Brackets, aluminum, black	661-6739-1B	661-6737-1B	661-6735-1B	661-6739-1B	661-6737-1B	661-6735-1B	\$90
Blades, polycarbonate	661-6749-2	661-6747-2	661-6745-2	661-6739-2	661-6737-2	661-6735-2	\$49



SPOILER IS FULLY INSTALLED ON THE BUMPER COVER USING THE SPOILER MOUNTING KIT

ALUMINUM SPOILER MOUNTING KIT

- » Everything needed to mount the polycarbonate spoiler blade to the bracket, & the bracket to the bumper cover
- » 76-piece kit includes: 32 lightweight machined aluminum inner & outer washers, 22 flat head socket screws & 22 locknuts

Spoiler Mounting Kit	000-67K	\$33
----------------------	---------	------





FULLY MOUNTED POLYCARBONATE RUB RAIL



POLYCARBONATE RUB RAIL

- » Protect your vinyl without hiding it!
- » Attach to side of body to eliminate tire marks on fenders, doors, and quarter panels
- » Ultra-durable polycarbonate to absorb impact
- » Can be trimmed to fit your application

Rub Rail, 75" long	000-2100	\$21 ea
--------------------	----------	---------



PLASTIC VERSION INCLUDES CURVED EDGE FOR OPTIMUM AERODYNAMICS



000-5501P-W
MOLDED PLASTIC STANDARD ROCKER PANEL

ALUMINUM VERSION HAS ENDS ROLLED BY SPECIAL PROCESS, ENHANCING AIR FLOW



000-5501A-W
ALUMINUM STANDARD ROCKER PANEL



000-5500A-W
ALUMINUM STRAIGHT ROCKER PANEL

EDGES ARE LEFT STRAIGHT, NOT CURVED

MOLDED PLASTIC & ALUMINUM ROCKER PANELS

- » Mounts below the fender / door / quarter panel area and fits either side
- » Curved edges provide optimum aerodynamics and adds structural integrity to side body panels
- » Manufactured in high-impact plastic and lightweight aluminum
- » Available in 5 color options

			W B	CB R Y
High-Impact Plastic (N/A IN YELLOW)	000-5501P-x	82" x 5"	\$33	\$38
Aluminum	000-5501A-x	77-3/4" x 5"	\$39	\$39
Aluminum, straight	000-5500A-x	79" x 4-3/4"	\$39	n/a

FITS THESE BODY STYLES: ABC NEXTGEN, ABC, NEXTGEN LMSC, LMSC, NORTH AMERICAN SPORTSMAN, S2 SPORTSMAN, SHORT TRACK TRUCK, STREET STOCK



WEIGHS LESS THAN 2 LBS



ALUMINUM WINDOW BRACES

- » Strongest window braces on the market
- » Designed to the exact contour of your Five Star windows
- » Made of premium high-strength aluminum with flat black powder-coated finish
- » Foam-padded surface won't scratch your windows
- » Pre-drilled holes to mount adjustable bracing from the interior dash
- » **Kit includes:** 3 aluminum braces & installation hardware

Windshield Brace Kits		C=Center, L=Left, R=Right, O=outer, all 1" Wide	
ABC Next Gen Windshield Brace Kit	11002-76333	24-1/8"(C), 24-1/4"(L), 24-1/2"(R)	\$76
NextGen Late Model Stock Car Windshield Brace Kit	13002-76333	25-5/8"(C), 25-1/2"(L), 25-5/8"(R)	\$76
ABC/LMSC/Straight-Up Metal Windshield Brace Kit	564-6301	28-5/8" x 1"	\$76
North American Sportsman Windshield Brace Kit	12001-76333	26" x 1"	\$76
Pavement Modified Windshield Brace Kit	020-6301	26-1/2" x 1"	\$76
Short Track Truck Windshield Brace Kit	21001-76333	31-5/8"(C), 31-3/4"(L), 31-1/2"(R)	\$76
Rear Window Brace Kits		C=Center, L=Left, R=Right, O=outer, all 1" Wide	
ABC NextGen Rear Window Brace Kit	11002-76133	30-7/8"(C), 30-5/8"(O)	\$76
NextGen Late Model Stock Car Rear Window Brace Kit	11002-76133	30-7/8"(C), 30-5/8" (O)	\$76
ABC/LMSC/Straight-Up Metal Rear Window Brace Kit	674-6101	32" x 1"	\$76
North American Sportsman Rear Window Brace Kit	12001-76133	31-1/4"(C), 30-1/2"(O)	\$76
Pavement Modified Rear Window Brace Kit	020-6101	34" x 1"	\$76



IMPORTANT:
 USING RIVETS APPLIES TOO MUCH PRESSURE TO YOUR WINDOW & WILL FRACTURE THE POLYCARBONATE



WINDOW INSTALLATION KIT

- » Using proper hardware provides the perfect fit & helps to increase the life of your window
- » Black oxide coated to prevent rust
- » Enough hardware to install a complete set of windows on one car
- » **Kit includes:** 120 6-32 1/2" & 16 6-32 3/4" flat head socket screws, 136 6-32 nylon locknuts, 1 long-arm hex key & 9/64" drill bit

Window Installation Kit	805	\$23
-------------------------	-----	------

WINDOW INSTALLATION COUNTERSINK DRILL BIT

- » 3/8" diameter steel bit, 1/4" shank, used for countersinking holes for window screw installation into polycarbonate
- » Not required for pre-cut to fit, beveled, & drilled windows

Drill Bit	805-1	\$19
-----------	-------	------

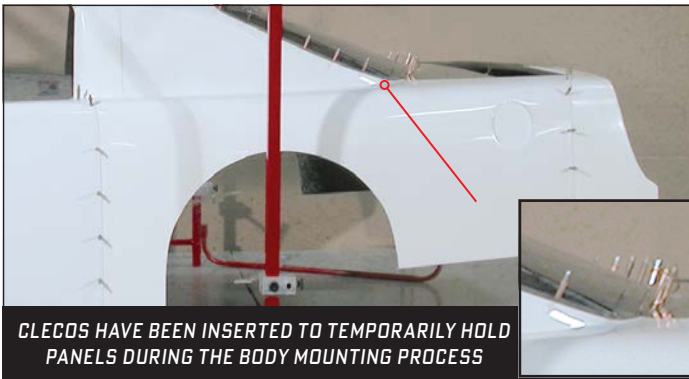

CLECOS HAVE BEEN INSERTED TO TEMPORARILY HOLD PANELS DURING THE BODY MOUNTING PROCESS



1/8"



3/16"

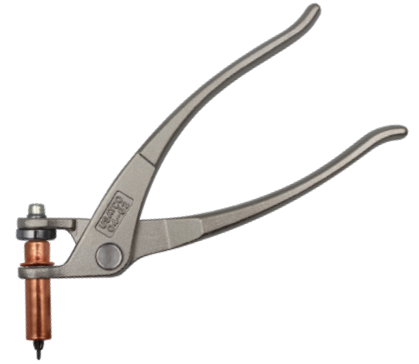

CLECO KIT & PLIERS

- » Precision has never been this easy! Cleco Pliers & Cleco Fasteners ensure perfect alignment every time
- » Clecos can be easily inserted with the Cleco Pliers to temporarily hold panels during the body mounting process
- » Our Cleco pliers are engineered for comfort & built to last, ensuring a secure grip & maximum control
- » Choice of 1/8" 25-piece Cleco Kit or 3/16" 25-piece Cleco Kit

1/8" Single Spade Kit, long	812	\$24
3/16" Single Spade Kit, long	813	\$32
Cleco Pliers	811	\$12

RIGHT SIDE DOOR SUPPORT

- » Easily adjust your right side door to the proper width
- » This piece connects your right side door bar to your door
- » .080" thick aluminum laser-cut to reduce weight
- » Laser cutting allows for precise, consistent shape & weight
- » Slotted mounting holes allow for easy inner & outer door adjustments to proper width
- » Weighs under 2 lbs

Aluminum Door Support	11002-75533	\$30
-----------------------	-------------	------



FULLY INSTALLED 11002-75533



DETAILS AND



DIMENSIONS

DRILL BIT KIT

- » Special double-ended drill bits
- » These bits drill a slightly larger diameter hole than a standard 1/8" or 3/16" bit to prevent stress cracks in the material
- » The short drill shaft makes drilling in tight places easier
- » Kit includes: 2 9/64" double-ended drill bits & 2 #30 double-ended drill bits

Drill Bit Kit	806	\$18
---------------	-----	------



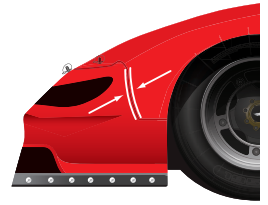
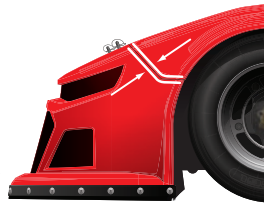
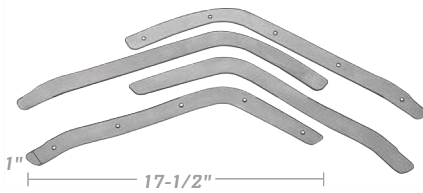

11002-75133

FOR ABC NEXTGEN, 2020 LATE MODEL STOCK CAR, NORTH AMERICAN SPORTSMAN

000-24B

FOR ABC, LMSC, S2, STRAIGHT-UP METAL, DIRT GRAND NATIONAL

FENDER-TO-NOSE BACK-UP PLATES KIT

- » Reinforces the flange where the fenders mount to the nose
- » Pre-drilled holes in the necessary locations for quick & easy mounting
- » Made of .063" thick aluminum
- » 4-piece kits include: 2 front & 2 rear plates (ENOUGH FOR BOTH SIDES)

ABC NextGen / NextGen LMSC / NA Sportsman	11002-75133	\$20
Other Body Styles*	000-24B	\$21

*FITS THESE BODY STYLES: ABC, LMSC, S2, STRAIGHT-UP METAL, DIRT GRAND NATIONAL

GREENHOUSE-TO-QUARTER PANEL BACK-UP PLATES KIT

- » Reinforce the flanges where the rear greenhouse meets the quarter panels
- » Universal fit for all greenhouse-style quarter panels
- » Each back-up plate is 60 X 1-12"
- » Recommended for molded plastic quarter panels
- » Kit includes: 2 pre-cut aluminum strips

2-piece Kit	000-27B	\$7
-------------	---------	-----

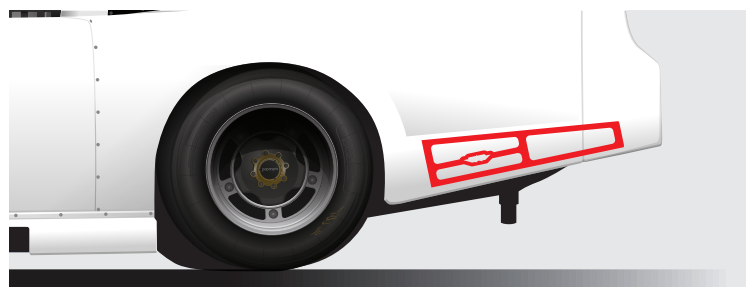
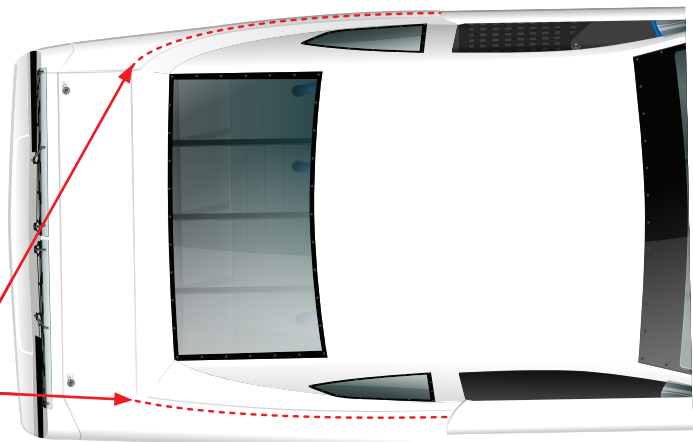

WEIGHS ONLY 1 LB

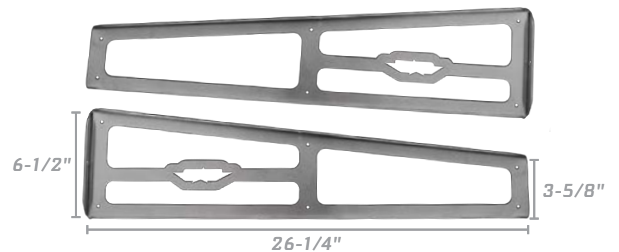

QUARTER PANEL BODY BRACE KIT

- » Stiffens the quarter panel to maintain correct shape in an aero sensitive area
- » Highly recommend bracing for tracks 1/2-mile & longer
- » Laser-cut aluminum braces have pre-drilled holes for brace attachment
- » Kit includes: 2 braces that mount approximately 6" back from the wheel opening & 2" up from the bottom ledge

Brace Kit, 2-piece	11002-75433	\$39
--------------------	-------------	------



EASY INSTALLATION WITH ENDS SHAPED FOR INCLUDED SCREW KIT OR 2 RIVETS



ADJUSTABLE BODY BRACES

- » Used for spoiler & roof supports & anywhere on your car to fit templates & meet other critical dimensions
- » Easy installation with ends shaped for included screw kit or 2 rivets
- » Adjustable from 8" to 10-1/2" & features durable anodized black finish & zinc-plated hardware
- » Add extra support without adding excess weight! Package of 2 weighs only 1/2 lb
- » Can also be attached to Five Star's Chassis Clamps for quick & easy adjustable bracing on your chassis

Body Braces, 2 pack	807-3	\$35
---------------------	-------	------

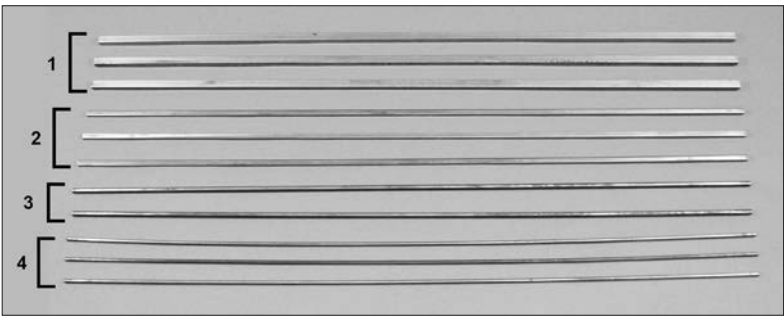

Number	Shape	Dia	Thickness	Length
1	(3) round	3/8"	.062"	60"
2	(3) square	1/2"	.035"	60"
3	(2) round	1/2"	.062"	60"
4	(3) square	3/4"	.049"	60"

STEEL TUBING INSTALLATION KIT

- » 55 feet of .035" hard-to-find, lightweight steel tubing for any miscellaneous needs on a race car
- » Will save at least 12 lbs over standard .065" steel tubing
- » Kit includes various shapes and sizes in 60" lengths

11-pcs: 60" lengths	819	\$79
---------------------	-----	------



FORMED POLYCARBONATE BODY BRACES

- » Universal brace to fit any applicable area of your car
- » Each lightweight brace weighs only 7 oz
- » Absorbs impact & allows body panels to flex upon impact & return to original position & shape
- » Kit includes: 7 clear polycarbonate braces & 14 1"x2" aluminum mounting tabs

Polycarbonate Braces	804	\$30
----------------------	-----	------

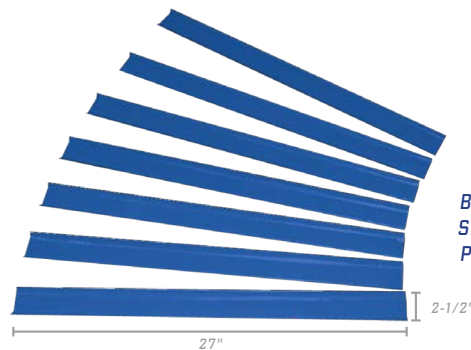

BRACES ARE SHOWN WITH PROTECTIVE MASKING



FULLY INSTALLED CUSTOM BRACE KIT



TAP | 807L OR 807R



THREADED END ASSEMBLIES | 807-2



ALUMINUM TUBING | 807-1

ALUMINUM CUSTOM BRACING KIT

- » Build your own custom-length bracing as short as 6" or as long as 40"
- » Order as many tubing kits or end assemblies as needed to custom brace your car
- » Threaded end assemblies can be bolted, riveted, or attached with hose clamps
- » **Complete kit includes:** 1 aluminum tubing kit; 1 threaded end assembly kit; 1 left & 1 right 1/4-20 reusable tap
- » **Aluminum Tubing kit includes:** 2 7/16" x 3' hollow hex rods. Cut to desired length & can be tapped easily
- » **Threaded End Assemblies kit includes:** 2 right and 2 left threaded ends, 2 hose clamps that weighs 7.5 oz

Complete Kit	807	\$68
REPLACEMENT PARTS		
Tubing Kit, 2-piece	807-1	\$29
End Assemblies, 6-piece	807-2	\$19
Tap, left or right	807LorR	\$10



CLOSE UP OF FULLY INSTALLED TAB



STEEL BODY MOUNTING TABS

- » Designed to be welded onto chassis as a universal mount for many applications
- » Makes mounting easier by positioning bracing and mounts right where you need them
- » 25-piece kit includes enough lightweight weld-on tabs to install a complete body & weighs 5 oz
- » Each tab is 1-1/8" x 1-2"
- » Use for roof, cowl, deck lid, side bracing, and more

25 Piece Kit	807-4	\$24
--------------	-------	------



TWO BRACES CAN BE MOUNTED & BRANCHED OFF A SINGLE MOUNTING END

THUMB SCREW FOR QUICK, EASY ADJUSTMENT TO MEET CRITICAL DIMENSIONS

TWO BRACES CAN ALSO BE MOUNTED TO A FIVE STAR CHASSIS CLAMP

STAMPED ALUMINUM MOUNTING END CLOSE-UP

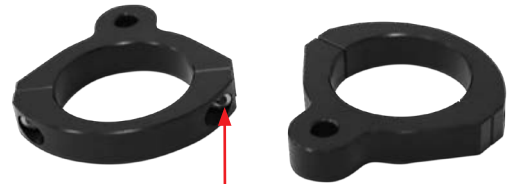

INCLUDES TWO SCREWS FOR QUICK, EASY INSTALLATION & ADJUSTMENT WITH 3MM ALLEN WRENCH

» NYLON (MOST FLEXIBLE) WEIGHS 5 OZ EA

» ALUMINUM (LIGHTEST) WEIGHS 3.25 OZ EA

» STEEL (MOST DURABLE) WEIGHS 8.25 OZ EA

PREMIUM ADJUSTABLE BODY BRACE KITS

- » Available in three options: aluminum, nylon, or steel
- » Adjustable to a maximum length of 30-1/2"
- » Stamped, black anodized aluminum mounting ends
- » Thumb screw for quick, easy length adjustments without tools
- » Kits come complete in a pack of 2

Flexible Nylon Brace Kit	10001-75951	\$33
Aluminum Brace Kit	10001-75933	\$30
Steel Brace Kit	10001-75931	\$21

ALUMINUM CHASSIS CLAMPS

- » Universal mount fits anywhere bracing is needed
- » Eliminate the need for welding or use of hose clamps when mounting body braces
- » Threaded flange / no nut required
- » Three options to fit different roll bar tubing thickness
- » Lightweight black anodized aluminum, each clamp weighs just 1.3 oz
- » Ideal for use with Five Star's Premium Adjustable Body Braces
- » Kits include: 2 clamps with 1/4-20 screws

1-1/2", aluminum, 2 pack	10001-74133	\$21
1-3/4", aluminum, 2 pack	10001-74333	\$21
1-5/8", aluminum, 2 pack	10001-74533	\$21



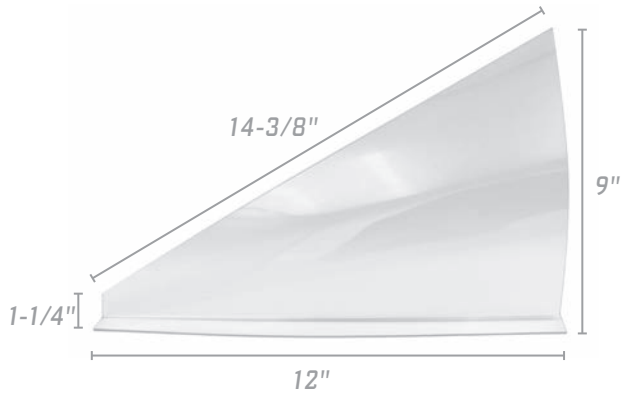

THE 11002-66222 DOOR VENT WINDOW IS CUT-TO-FIT FOR FAST & EASY INSTALLATION

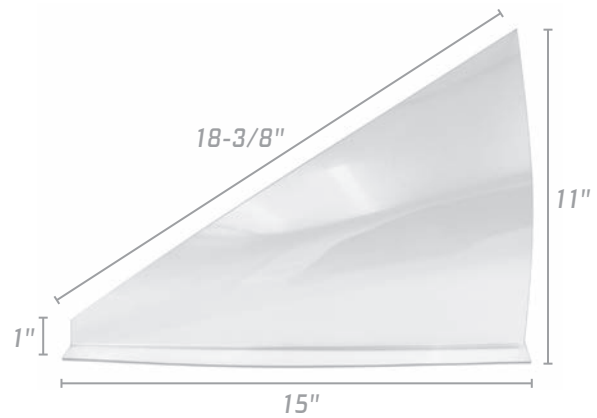

THE 000-6202 DOOR VENT WINDOW IS OVERSIZED; TRIM TO FIT YOUR APPLICATION



POLYCARBONATE DOOR VENT WINDOWS

- » Molded vent windows give cars a proven performance gain in the wind tunnel over flat unmolded windows
- » Oversized and cut-to-fit options made of molded, mar-resistant coated clear .093" polycarbonate

Precut-to-fit, set of 2	11002-66222	\$33
<i>FITS THESE BODY STYLES: ABC NEXTGEN, NEXTGEN LMSC</i>		
Universal, set of 2	000-6202	\$35

WIDE ANGLE RACING MIRROR

- » This convex glass mirror gives you the best view of your competition, includes a bracket kit for easy installation
- » All black frame with black anodized machined aluminum brackets
- » Only weighs 19 oz

Convex Glass Mirror	00001-85020	\$39
---------------------	-------------	------



UNIVERSAL MIRROR MOUNTING BRACKET

- » This stamped lightweight aluminum bracket allows for easy installation on any chassis
- » Satin black powder coated finish

Replacement Bracket	820-B	\$9
---------------------	-------	-----



THE PERFECT SURFACE PREP FOR PLASTIC

MD3 ADHESION PROMOTER

NEW!



FAST DRYING & NON-SANDING



MD3 ADHESION PROMOTER

- » Specifically engineered adhesion promoter assures proper paint bonding to our special plastic
- » Other automotive grade primers on the market may not work at all or cause severe paint flaking
- » Improves adhesion of vinyl by enhancing the bond between adhesive on the vinyl and the substrate, for a more durable, long-lasting application
- » Comes in an aerosol spray can for quick and easy application
- » A single can coats approximately 5 individual parts

MD3 Adhesion Promoter	842	\$16
-----------------------	-----	------

» A MUST USE PRODUCT BEFORE PAINTING OR APPLYING VINYL ON ANY FIVE STAR PLASTIC PART

FIVE STAR PLASTIC WINDOW CLEANER

- » This specially formulated anti-static foaming spray contains no chemicals or abrasives that will cause damage to plastic
- » Lifts grease, grime, and wipes off fast and easy to provide a streak-free clean and clear surface finish

Window Cleaner, 19oz Can	843	\$9.95
--------------------------	-----	--------

» FIVE STAR CLEANING TIPS!

- » ALWAYS AVOID USING ABRASIVE CLEANERS & CHEMICAL SOLVENTS THAT CAN EASILY CAUSE DAMAGE TO POLYCARBONATE WINDOWS
- » USE A MICROFIBER TOWEL FOR BEST, STREAK-FREE FINISH
- » TO PREVENT SCRATCHING AND HAZING ON YOUR WINDOWS, NEVER SCRUB WITH BRUSHES OR ABRASIVE MATERIALS



PRICING SUBJECT TO CHANGE WITHOUT NOTICE

UNIVERSAL SHORT TRACK

NOSES, BUMPER COVERS & COMPONENTS

VINYL NOSE GRAPHIC ID KITS FOR A REALISTIC OEM LOOK!

PRINTED ON OUTDOOR DURABLE HIGH-TACK VINYL • GLOSSY LAMINATED SURFACE PROVIDES EXCELLENT PROTECTION



'97 CHEVROLET CAMARO

-W

Nose	150-410-W	\$178
------	-----------	-------

*NOSE GRAPHIC ID KITS NO LONGER AVAILABLE

'97 CHEVROLET CAMARO

-W

Bumper Cover	150-450-W	\$160
--------------	-----------	-------

*BUMPER COVER GRAPHIC ID KITS NO LONGER AVAILABLE



'92 CHEVROLET CAMARO

-B -W

Nose (PAVEMENT)	140-410-x	\$178
-----------------	-----------	-------

Nose ID Kit	140-410-ID	\$37
-------------	------------	------

'92 CHEVROLET CAMARO

-B -W

Nose	145-410-x	\$178
------	-----------	-------

Nose ID Kit	140-410-ID	\$37
-------------	------------	------



'81 CHEVROLET CAMARO

-B

Nose, Upper	210-410U-B	\$80
-------------	------------	------

*NOSE GRAPHIC ID KITS NO LONGER AVAILABLE

'81 CHEVROLET CAMARO

-B

Nose, Lower	210-410L-B	\$75
-------------	------------	------

*NOSE GRAPHIC ID KITS NO LONGER AVAILABLE



'03 CHEVROLET MONTE CARLO

-B -W

Nose (FG SPORTSMAN)	639-410-x	\$178
Nose (SHORT TRACK)	640-410-x	\$178
Nose ID Kit	630-410-ID	\$37



'03 CHEVROLET MONTE CARLO

-B -W

Bumper Cover	630-450-x	\$160
Bumper Cover ID Kit	630-450-ID	\$36



'99 CHEVROLET MONTE CARLO

-B -W

Nose	620-410-x	\$178
Nose ID Kit	620-410-ID	\$37

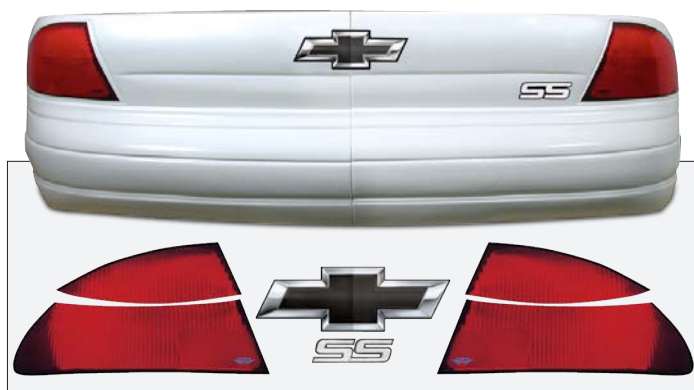

'99 CHEVROLET MONTE CARLO

-B -W

Bumper Cover	620-450-x	\$160
Bumper Cover ID Kit	620-450-ID	\$36



'94 CHEVROLET LUMINA

-W

Nose	610-410-W	\$178
------	-----------	-------

*NOSE GRAPHIC ID KITS NO LONGER AVAILABLE



'94 CHEVROLET LUMINA

-W

Bumper Cover	610-450-W	\$160
--------------	-----------	-------

*BUMPER COVER GRAPHIC ID KITS NO LONGER AVAILABLE



'03 FORD TAURUS

-B -W

Nose	550-410-x	\$178
Nose ID Kit	550-410-ID	\$37



'03 FORD TAURUS

-B -W

Bumper Cover	550-450-x	\$160
--------------	-----------	-------

**BUMPER COVER GRAPHIC ID KITS NO LONGER AVAILABLE*



'97 FORD THUNDERBIRD

-W

Nose	530-410-W	\$178
------	-----------	-------

**NOSE GRAPHIC ID KITS NO LONGER AVAILABLE*



'97 FORD THUNDERBIRD

-W

Bumper Cover	530-450-W	\$160
--------------	-----------	-------

**BUMPER COVER GRAPHIC ID KITS NO LONGER AVAILABLE*



PONTIAC GRAND PRIX

-B -W

Nose	360-410-x	\$164
Nose ID Kit	360-410-ID	\$37

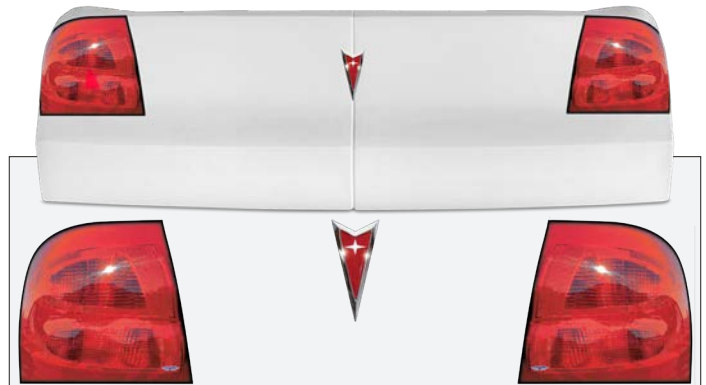

PONTIAC GRAND PRIX

-B -W

-CB -R

Bumper Cover	460-450-x	\$155	\$160
Bumper Cover ID Kit	360-450-ID	\$36	\$36



'97 OLDSMOBILE CUTLASS

-W

Nose	710-410-x	\$178
Nose ID Kit	710-410-ID	\$37



H00-410S: Round, small \$8



H01-410S: Rectangle, small \$8



H00-411S: Round, large \$8



H01-411S: Rectangle, large \$8

NEW!

ACHIEVE MAXIMUM VINYL ADHESION BY USING MD3 ADHESION PROMOTER. DETAILS AND ORDERING INFORMATION ON PAGE 147!



» ALUMINUM NOSE SCREENS: PROTECT YOUR RADIATOR FROM DEBRIS PENETRATION

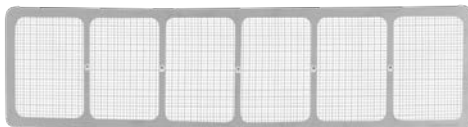

UNPAINTED

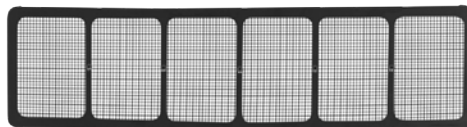

BLACK POWDER-COATED

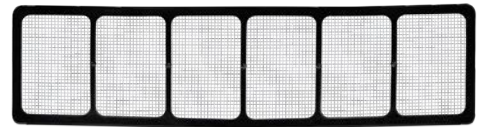

BLACK ALUMINUM FRAME

ALUMINUM NOSE SCREENS

- » Protects the radiator from debris penetration
- » Frame is laser cut from lightweight aluminum
- » Screen is high strength stainless steel (3/16" mesh is crimped, 1/4" is welded)
- » Available options: black aluminum frame, unpainted, or with durable satin black powder-coated finish

PN	NOSE SCREEN DESCRIPTION	WIDTH (Top)	WIDTH (Bottom)	HEIGHT	MESH	
630-4111	O1 Monte Carlo, Lower	34"	34"	6"	3/16"	\$50
660-4111	Common*, Lower	27-3/4"	27-3/4"	7-1/4"	3/16"	\$50
660-4111-B	Common, Lower, Black	27-3/4"	27-3/4"	7-1/4"	3/16"	\$55
660-4112	Common, Lower	27-3/4"	27-3/4"	7-1/4"	1/4"	\$50
660-4112-B	Common, Lower, Black	27-3/4"	27-3/4"	7-1/4"	1/4"	\$55
10001-46333B	Common, Lower, Black aluminum frame	27-3/4"	27-3/4"	7-1/4"	3/16"	\$55
10001-46433B	Common, Lower, Black aluminum frame	27-3/4"	27-3/4"	7-1/4"	1/4"	\$55

*COMMON NOSE SCREEN FITS THESE BODY STYLES: ABC NEXTGEN, ABC, NEXTGEN LATE MODEL STOCK CAR, LATE MODEL STOCK CAR, NORTH AMERICAN SPORTSMAN, STRAIGHT-UP METAL, MD3 CAMARO/MUSTANG STREET STOCK, DIRT GRAND NATIONAL

PRICING SUBJECT TO CHANGE WITHOUT NOTICE

ABC LMSC TRUCK PAV/MODIFIED OUTLAW LATE MODEL SPORTSMAN STREET STOCK MD3 LATE MODEL MD3 MODIFIED DIRT GRAND NAT'L TAZ PRO STOCK/MOD FUNNY CAR WINDOWS ACCESSORIES